

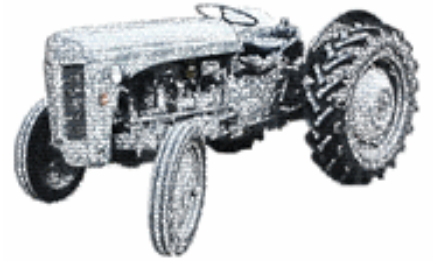

L.O.G Heigl



REPLACEMENT PARTS SUITABLE FOR

FORD & NEW HOLLAND

TRACTORS



Engine Parts	4	
Stanadyne & Soltron	16	
Fuel Parts	17	
Sender Units	19	
Injector Pipes	20	
TS/TM Fuel Pumps	24	
Stop Cables	25	
Engines Parts & Frost Plugs	29	
Pistons & Rings	30	
Oil Pumps	38	
Exhausts	40	
Exhaust Manifolds	47	
Cooling	50	
Pumps	50	
Fanbelts	54	
Radiators	61	
Hoses	64	
Filters	67	
Air Filters	67	
Oil Filters	75	
Hydraulic Filters	76	
Fuel Filters	78	
Filter Kits	80	
Axle Parts	85	
TRE's	85	
5/6/7000 2WD Manual TRE's	86	
40's Carraro Axle	98	
New Holland Axle	102	
Spindles	108	
Stub Axle Components	112	
Front Axle	113	
P/S Conversion Kits	114	
2/3/4000 Steering	115	
4/5/7600 Manual Steering	116	
5/7600 Power Steering	118	
P/S Pumps	123	
Cab, Sheet Metal & Electrical	125	
Mudguards & Weights	125	
Wheel Studs & Nuts	127	
Wheel Rims & Tyres	128	
Decals	130	
Seats	136	
Fordson N	139	
Fordson Major	140	
Dexta	141	
Dexta Dash	142	
Bonnets	144	
Footsteps	146	
Paint	148	
Window	151	
Mirrors	152	
40's Cab Parts	159	
TL TM TS Cab	162	

Glass	168	
Rubber	185	
Lamps	186	
Electrical Components	199	
Starters	200	
Alternators	204	
Clutch, Transmission & PTO	210	
Clutches	210	
Dexta/Major - 2/3000	210	
4000-4600	211	
5000-6600	212	
5610-7610	213	
7810/8210 - TW	214	
TS/40 Series	215	
TM/TSA/TL & Dampers	218	
Gearbox	221	
Gearbox Parts	221	
4000 Transmission	223	
5/6600 Transmission	224	
7610/7710/6610 Transmission	226	
16x16 Transmission Top Shaft	228	
Transmission Lower Shafts	229	
40's/TM Transmission Components	230	
TW Dual Power	235	
10's D/P	236	
PTO	241	
Vintage PTO Parts	241	
5/6/7600 PTO	242	
40's PTO	248	
30's TW	250	
PTO Shafts	252	
Brakes	255	
Major	255	
Dexta	257	
Brakes 2/3/4/4600/5/5/76/10	259	
Cables	266	
Hydraulics	268	
Vintage	269	
Misc Parts	269	
Hydraulic Pumps	270	
Lift Covers	270	
Linkage	282	
Levelling Boxes	282	
Pick Up Hitches	285	
Chain Stabilisers	288	
Top Links	292	
Quick Release Ends	296	
Levelling Parts	298	
Linkage CBM	308	
Dromone	309	



Complete Engines

43600

Engine Ford 4630 4130 3930 - 3 Cylinder Turbo
OE Ref: 87800478



43658

Engine Ford 4610 L865 LX865 Loader Turbo
OE Ref: 87801409



Silicone & Gasket Sealer



1861108
Silicone Sealer - 80ml



1861117
Gasket Sealer - 100g



1475
Silicone Sealer 300ml



1478
Gasket Sealer 350g

Gasket Paper

Plain

Sold Per Metre

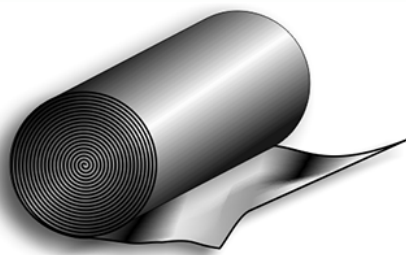

3167 - 0.80 Mm Paper
3168 - 1.00 Paper

Cork

Sold Per Metre

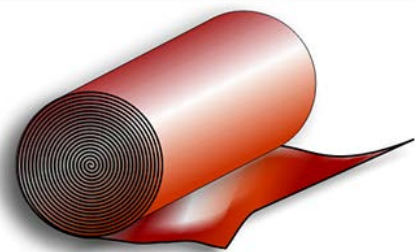

3171 - 3 Mm Cork

Head Sets & Sump Sets

3 Cylinder

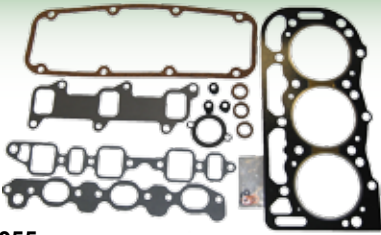

2055
Head Gasket Set Ford 3610 4110 4600
4610 c/w Genuine Head Gasket
** 2055R is Replacement Type **

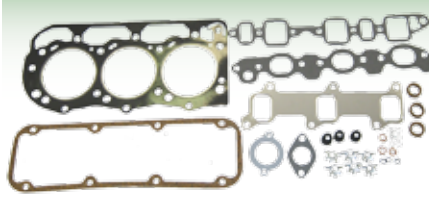

2055R
Head Gasket Set Ford 3610 4110 4600 4610
* 2055 has Genuine Head Gasket *
* Kit 2055 * [OE Ref: CFPN6008B](#)



3741
Sump Gasket Set Ford 2000 3000 4000
4600

4 Cylinder

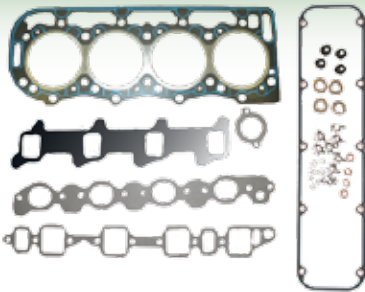

42230G
Head Gasket Set Ford 10 4 Cylinder c/o
Genuine Head & Rocker Cover Gaskets
*3375 is Replacement Type *

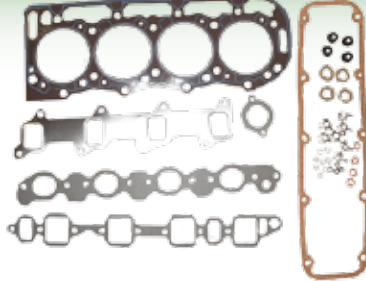

3375
Head Gasket Set Ford 5610 6610 7610
5600 7600 4 Cylinder 10s ** Kit 42230G
has Genuine Head & Rocker Gaske



3740
Sump Gasket Set Ford 5000 7600
5610 6610 6710 7710 5610 6610 6710
7710



42232G
Head Gasket Set Ford 40 4 Cylinder c/o
Genuine Head & Rocker Cover Gaskets
** 42232 is Replacement Type **

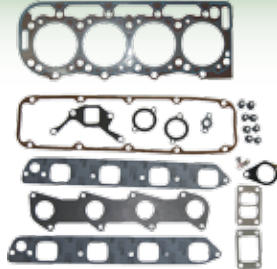

42232
Head Gasket Set Ford 40 4 Cylinder **
42232G has Genuine Head & Rocker
Gasket **



4188
Sump Gasket Set Ford 5640-7740

43590
Gasket Set New Holland
TN85 TN95 TL70A 80A NE
90A 100A TD5040 TD5050
T5030 T5040 T5050 T5060
T5070 T4030 T4040 T4050
Case JX90 JX95
[OE Ref: 2830645](#)

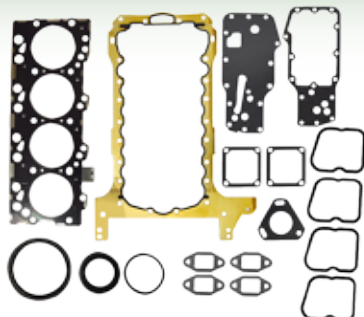

43591
Gasket Set Ford
T6020 T6010 T6040
T6060 TS100A
TS110A NEF
[OE Ref: 4894295](#)

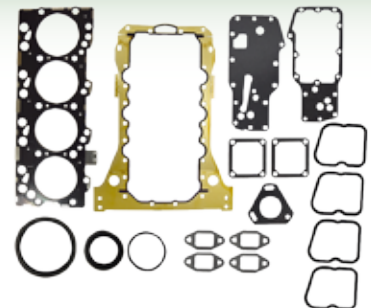

6 Cylinder

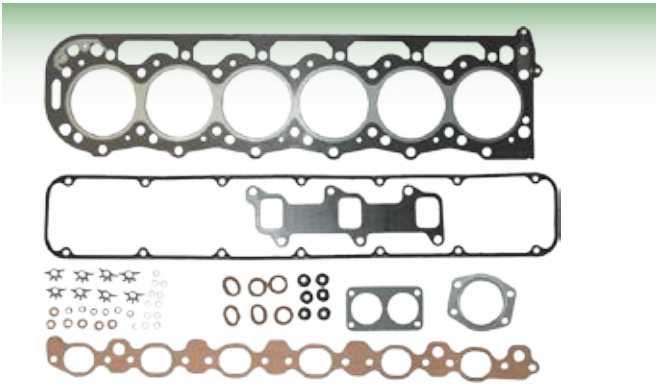

42231G

Head Gasket Set Ford 10 6 Cylinder
c/o Genuine Head & Rocker Cover Gaskets **
1957 is Replacement Type **

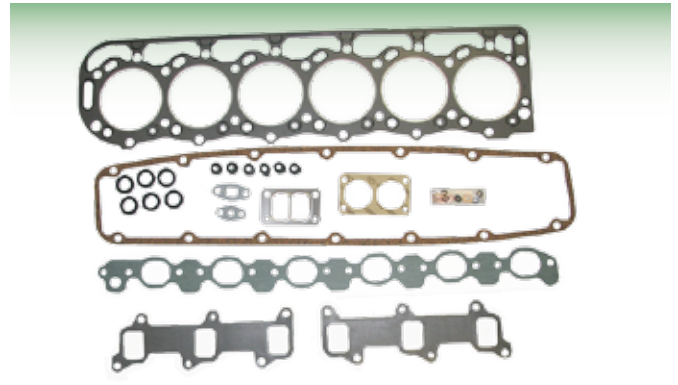

1957

Head Gasket Set Ford 7810 8210 TW ** Kit 42231G has Genuine
Head & Rocker Gaske

2909

Sump Gasket Set Ford TW 10 30



42233G

Head Gasket Set
Ford 40 6 Cylinder
c/o Genuine Head
& Rocker Cover
Gaskets ** 42233
is Replacement
Type **



42233

Head Gasket
Set Ford 40
6 Cylinder **
42233G has
Genuine Head &
Rocker Gasket **



4198

Sump Gasket Set Ford 7840



Head Gaskets



1279
Head Gasket Ford 2000 3000



1213
Head Gasket Ford 4000 4600 Genuine **
1213R is Replacement Type **



1213R
Head Gasket Ford 4000 4600
** Genuine is 1213 **



43007
Head Gasket Ford 4000 1.40mm Thick
** 1213R is 1.60mm Thick **



1214G
Head Gasket Ford 6600 7600 4 Cylinder
10s 4 Cylinder 40S ** Kits 42230G
42232G **



1214E
Head Gasket Ford 6600 7600 7610 **
Kit 42232 **

Q2830920
Gasket Cylinder Head 1.15mm 4 Cylinder NEF
TSA T6000 [OE Ref: 2830920](#)

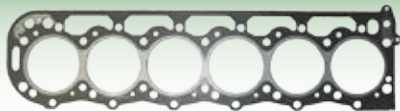

1949G
Head Gasket Ford TW 7810 7910 8210 Genuine ** Kit
42231G ** 1949I is Replacement Type **



1949I
Head Gasket Ford TW 7810 7910 8210 ** 1949G is Genuine **



401961G
Head Gasket Ford 7840 8240 TS115 Genuine ** Kit
42233G **



401961
Head Gasket Ford 7840 8240 TS115 ** 401961G is
Genuine ** ** Kit 42233 **



41878
Head Gasket Ford TM120 - TM190
G170 - G240 & 70 Series Genuine

Rocker Cover Gaskets

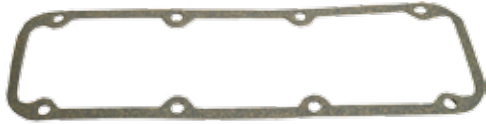

2065
Rocker Cover Gasket Ford 4000 After 1965

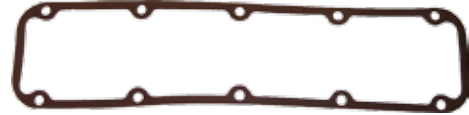

2066
Rocker Cover Gasket Ford 5610 7710 4 Cyl

409736
Rocker Cover Gasket Ford 10 4 Cyl Silicone Ge 5610
6410 6610 6710 6810 7410 7610 7710 ** Kits 42230G
42232G ** 4 Cyl

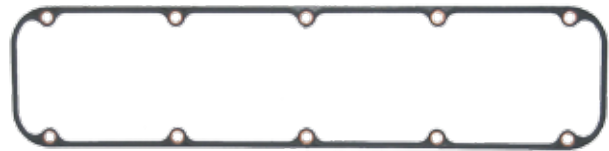

41016
Rocker Cover Gasket 6 Cylinder Ford



409917
Rocker Cover Gasket Ford 6 Cylinder Genuine 7810 7910 8210
TW 8530 8630 8730 8830 41016 is replacement



42250
Gasket Ford Intake Manifold TM TS

N Gaskets



48811
Valve Cover Gasket Fordson 8N
9N

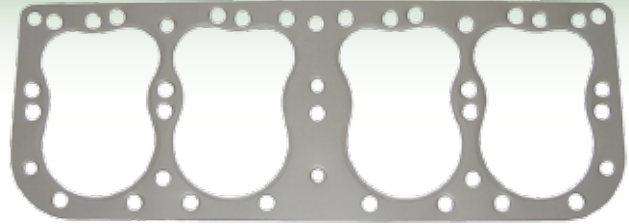

48810
Head Gasket Fordson 8N 9N Metal



48809
Exhaust Manifold Gasket
Fordson 8N 9N KIT



48831
Governor Housing Gasket Fordson 2N 8N 9N



48800
Carburettor Repair Kit Fordson 2N
8N 9N



48833
Oil Pump Cover Inlet Gasket
Fordson N's 600/700/800/900



0490481
Exhaust Manifold Gasket 35X Dexta
[OE Ref: 731268M1](#)



48827
Oil Relief Valve Gasket Fordson
2N/8N/9N

N Gaskets

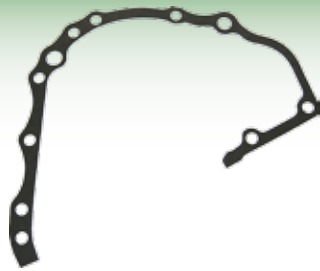

48828
Front Cover Gasket Fordson 8N <263843 Serial



48829
Front Cover Gasket Fordson 8N >263843 Serial

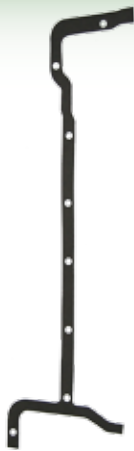

48835
Oil Pump Gasket Fordson 8N
9N RH



48812
Gasket Fordson N
Carburettor Bowl to Body
801/901



48841
Gasket Fordson N's
Carburettor Bowl to BodN
AA/2N/600/700/8N/800/
9N/900



48838
Air Cleaner Gasket Fordson NAA
600 8N



U5LT0012
Head Gasket Set 35 35X Copper Fordson Dexta

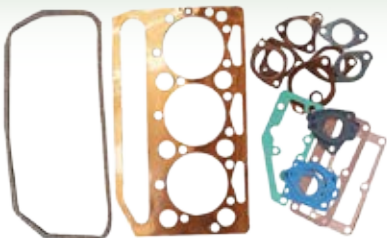

41625
Head Set Dexta & TE20 (P3
Engine)



41624
Sump Gasket Set P3 Dexta
** 41962 is for Dexta & Super
Dexta **



41962
Sump Gasket Set Dexta Super Dexta
** 41624 is for P3 **

Major & Super Major Gaskets



1094
Head Gasket Fordson Major Standard



48853
Head Gasket Fordson Major Heavy Copper Type
Note this is 1.9mm / 75 thou in thickness [OE Ref: 81710277](#)



1095
Major Rocker Cover Gasket



41459
Super Major Engine Side Cover Gasket

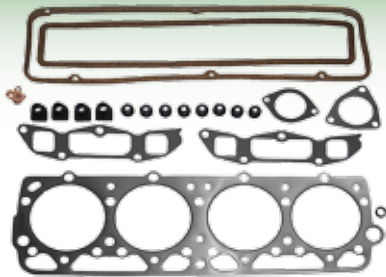

3056
Head Gasket Set Major



43147
Rope Seal For Crankshaft Major
Super Major



41475
Timing Cover Gasket
Super Major - Front

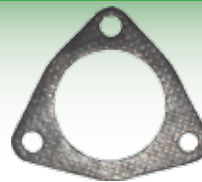

41469
Exhaust Elbow Gasket
Super Major



41219
Air Intake Manifold
Gasket Super Major



41300
Timing Cover Gasket
Major

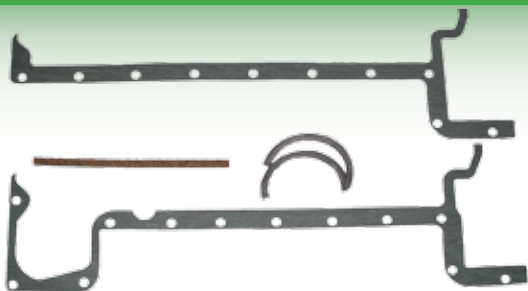

1096
Sump Gasket Set Major Super Major

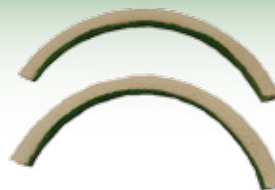

43147
Rope Seal For
Crankshaft Major
Super Major



881991
Seal 65 Half Shaft
Inner Timing Cover
Seal Super Major

3 Cylinder Individual Gaskets



2069
Sump Gasket Ford 2610 4610



2070
Timing Cover Gasket Ford

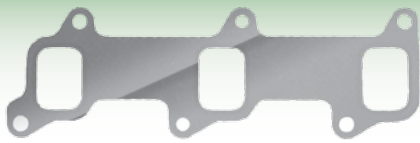

1173
Exhaust Manifold Gasket
Ford 4000 4600



1398
Water Pump Gasket Ford Dexta
2000 5000

1173S
Exhaust Manifold Gasket
Ford 3 Cylinder Steel



1402
Water Pump Gasket
Ford Inside



1171
Gasket Crankhaft Seal Ford Rear
**Seal & Gasket kit - 2269 **



3863
Thermostat Gasket Ford - All
Models

4156
Exhaust Elbow Gasket Ford



3675
Oil Pump Gasket Ford



2071
Air Intake Manifold Gasket Ford 3 Cylinder



3927
Air Intake Manifold Gasket Ford 3610

4 Cylinder Individual Gaskets



1929
Crankshaft Gasket Ford 7610 Rear



1171
Rear Crankshaft Seal Gasket



2006
Sump Gasket Ford 5000



1398
Water Pump Gasket



1402
Inside Water Pump Gasket

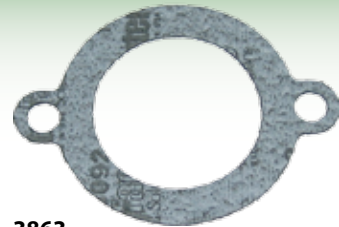

3863
Thermostat Gasket

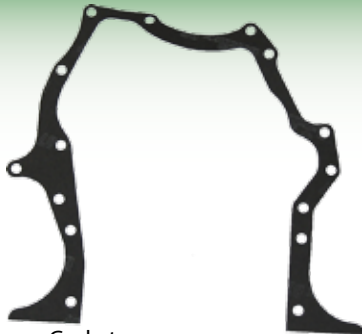

3674
Inner Timing Cover Gasket

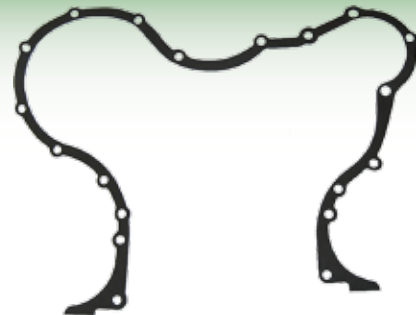

2070
Timing Cover Gasket



1172
Air Intake Manifold Gasket
Ford 5000 Square



1174
Exhaust Manifold Gasket Ford 5000

4121
Exhaust Manifold Gasket Ford 5600 6600



1379
Air Intake Manifold Gasket Ford Round

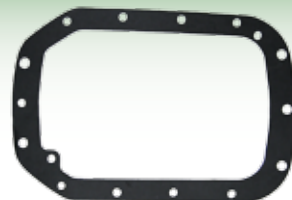

1176
Centre Housing Gasket Ford 5000 40s

Assorted Gaskets

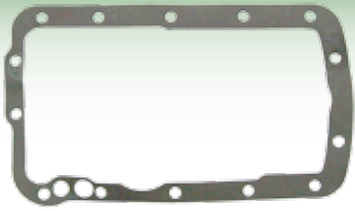

1196
Lift Cover Gasket Ford 4000



2384
4/4600 Hyd. Pump Gasket



3388
Hydraulic Pump Gasket Ford 5000

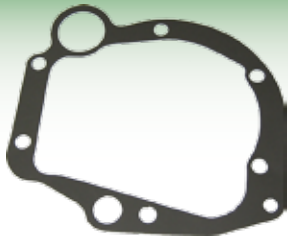

3862
Hydraulic Pump Gasket Ford 40 7610 **
Kit is 404605 **



3861
Hydraulic Pump Gasket
Ford 6600 7600



3245
Gearbox Lid Gasket Ford 5000



1523
Trumpet Housing Gasket Ford

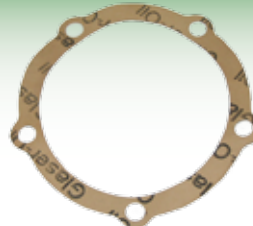

1524
Input Housing Gasket Ford



1177
Lift Cover Gasket Ford



1406
Gear Box Lid
Gasket Ford
4000 4600



41015
Sump Gasket Ford 7840 - 8340 TM120
- 190 TS115 TW10 - TW30 8530 - 8830
7810 - 8210



4757
Lift Cover Gasket
Ford TW15 20 Hyd.



41555
Exhaust Manifold Gasket Ford
7840 8340



4758
Hydraulic Pump
Housing Gasket
Ford TW15 20



409734R
Gasket Exhaust Manifold Ford New
Type **Made of Thick Gasket paper**

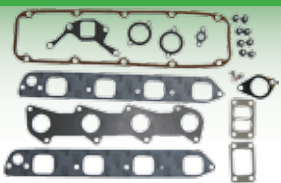

4194
Head Gasket Set Ford 5640 - 7740 No
Head Gask



42186
Head Gasket
Set Ford 7840
6 Cylinder no
Head



409734
Ford Exhaust Manifold Gasket
(New Type) 3 & 6 Cylinder

Soltron & Stanadyne

SOLTRON



52814 50ml **52815** 125ml **52816** 500ml **52817** 1 Litre

Part No.	ML	Initial Treatment 1:2,500	Refills 1:5,000
52814	50	125 Litres	250 Litres
52815	125	312.5 Litres	625 Litres
52816	500	1,250 Litres	2,500 Litres
52817	1 Ltr	2,500 Litres	5,000 Litres

Application:
For Petrol & Diesel Engines

- Benefits:**
- Eliminates diesel bugs
 - Removes tank sludge
 - Removes environmentally harmful emissions
 - Reduces engine wear
 - Improved fuel economy
 - Saves money

Protect Your Investment

STANADYNE

Fuel Additives



53489 250ml **53404** 500ml **53490** 5Ltr **53810** 10Ltr **53423** 25Ltr

Part No.	Size	Treats
53489	250 ml	125 litres
53404	500 ml	250 litres
53490	5 litres	2500 litres
53810	10 litres	5000 litres
53423	25 litres	12,500 litres

Application

- High pressure common rail
- Unit Injectors
- Rotary Distributor Pumps
- In-line pumps

Benefits

- Upgrades and stabilizes fuel by reducing sludge and fuel tank contaminants
- Cleans and protects fuel system components
- Removes varnish and other deposits to prevent plugging
- Helps remove water from fuel
- Regular use of Stanadyne can dramatically improve power, torque and miles per gallon, while reducing smoke and other harmful emissions
- Recommended by engine and vehicle manufacturers including John Deere
- Performance formula can reduce particulate emissions by up to 49%

Fuel System Parts



Nylon Fuel Pipe

- 3904** 1/4" Nylon Pipe (30 Meters)
3903 5/16" Nylon Pipe (30 Meters)

Steel Fuel Pipe

- 1917** 3/16" Steel Pipe (10 Ft)
1910 1/4" Steel Pipe (10 Ft)
1905 5/16" Steel Pipe (10 Ft)

Rubber Fuel Pipe

- 2604** 3/16" Fuel Hose (10 Mtr)
4525 3/16" Fuel Hose (Per Mtr)
2605 1/4" Fuel Hose (10 Mtr)
4526 1/4" Fuel Hose (Per Mtr)
2606 5/16" Fuel Hose (10 Mtr)
2607 3/8" Fuel Hose (10 Mtr)
4528 3/8" Fuel Hose (Per Mtr)



61348
Fuel Filter Blanking Plug KIT

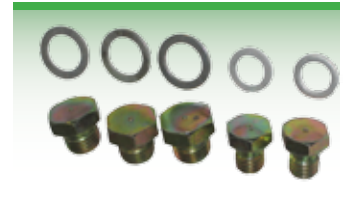

61709
Blanking Plug Kit For Fuel Filter Head

- 1721** 3/16" Barrel Olive
1296 1/4" Barrel Olive
1297 5/16" Barrel Olive
3430 3/8" Barrel Olive



61702
Fuel Filter Head Banjo Bolt



61707
Fuel Filter Head Blanking Plug All Models



1850167
Fuel Assembly Screw 20 TEF 35



Part No.	I.D.
3970	3/16"
3971	1/4"
3972	5/16"
3973	3/8"



41568
Fuel Tap Brass 2000 3000 4000 5000 7000 Fits 2636/46/56/66/7600 3900 ** Gauze 1426 * 4100 57/6700 5900 7600 7700 Fordson Major



1978
Fuel Line Pipe Union 1/4" Male



1924
Fuel Line Pipe Union 5/16" Male



62950
Joiner Fuel Pipe Brass Long



1974
3/16 Union Male Oil Pressure



1975
Heater Plug Pipe 3/16 Male



1973
Oil Pressure Pipe 3/16' Union F/M

Engine Parts

Fuel System Parts

51489
Fuel Strainer (Input/
Output 1/2" - 20 UNF)



51483
Hand Primer for Bosch
Type Fuel Pump M16 x 1.5



3416
Fuel Water Separator
Ford & Massey
Ferguson



61235
Fuel Filter Assembly 100
200 c/o Long Filter Also
Fits 4200 4300 6200



51482
Hand Primer
for Z Type Fuel
Pump M25 x 1.5



51492
Fuel Filter Head &
Base



51491
Fuel Strainer (Input/
Output M14 1.5)



51487
Fuel Filter Dual -
Inlet/Outlet M14
x 1.5



41874
Fuel Filter Assembly Ford
TM120 - TM155 **T6010 -
T6080 & T7030 - T7060**



43594 Water in Fuel Sensor M14
T6000 T7000 T6 T7 Series [OE Ref:](#)
[2853585](#)



43593
Water in Fuel Sensor M10
TS125A TS135A TS113A
[OE Ref:](#) 2830419



Dexta Throttle Linkage

41776
Throttle Lever Super Dexta Major



42043
Throttle Linkage
Super Dexta Small



41911
Throttle Linkage Dexta Small



42044
Throttle Linkage Dexta Medium - Standard



41910
Throttle Linkage Super Dexta Me-
dium



42045
Throttle Linkage Dexta Large -
Standard



41909
Throttle Linkage Super Dexta Large



Fuel Tank Senders



41872
Fuel Sender Ford TM120 - TM155 up to **Up to Serial No C5132**

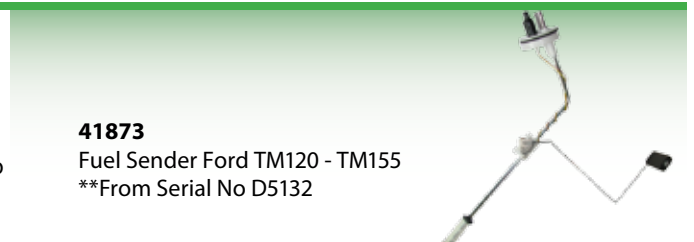

41873
Fuel Sender Ford TM120 - TM155
**From Serial No D5132

Super Q Cabs

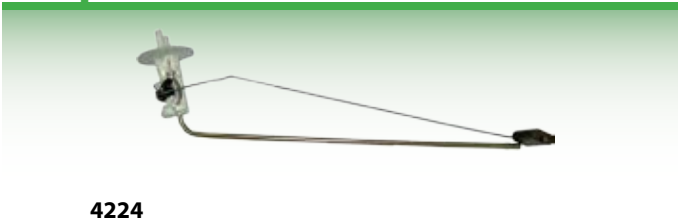

4224
Fuel Sender Manual Dash - 1985 -1987



4191
Fuel Sender Ford 7610 Electronic Dash (1985)

Q Cab



4170
Fuel Sender Ford 7610 Auxiliary

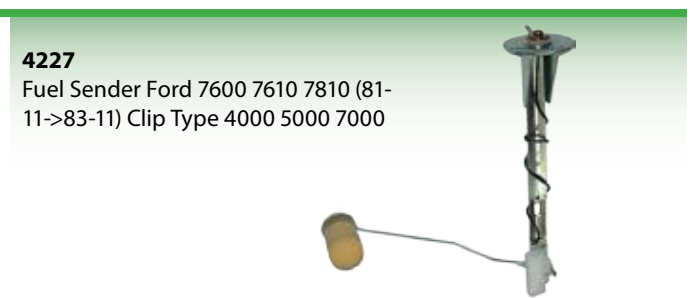

4227
Fuel Sender Ford 7600 7610 7810 (81-11->83-11) Clip Type 4000 5000 7000

AP Cab

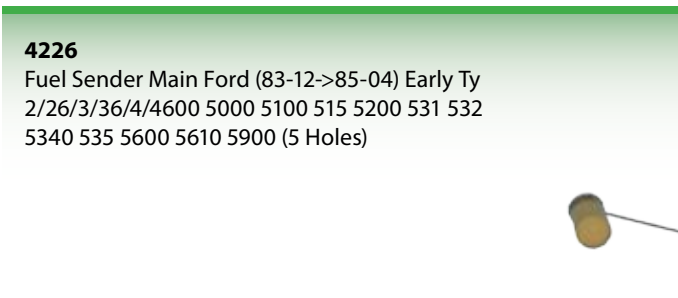

4226
Fuel Sender Main Ford (83-12->85-04) Early Ty 2/26/3/36/4/4600 5000 5100 515 5200 531 532 5340 535 5600 5610 5900 (5 Holes)

40's Cab



409720
Fuel Sender Ford 40 Auxiliary Fuel Tank 5640 6640 7740 7840 8240 8340

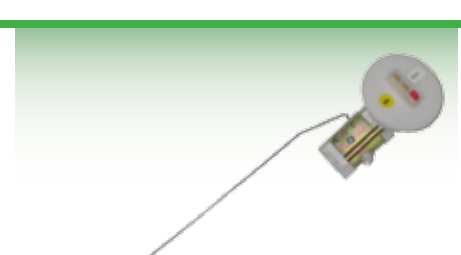

409721
Fuel Sender Ford 40 Main Fuel Tank 5640 6640 7740 7840 8240 8340 With Auxuiliary

New Holland



42898
Fuel Sender New Holland TD65 75 85 95

Injector Pipes



41159
Injector Pipe Ford No 1
(Simms Pump)

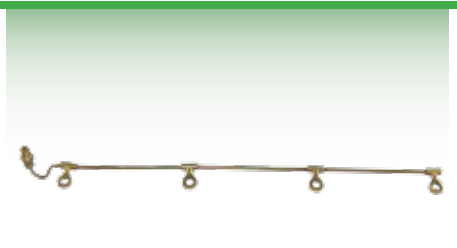

41460
Leak Off Pipe Major

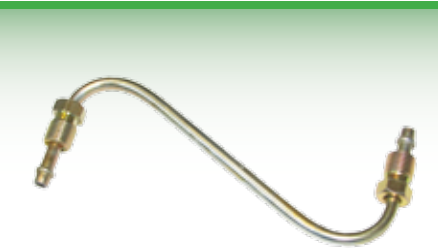

41642
Pipe Filter To Injector Pump
Fordson Major

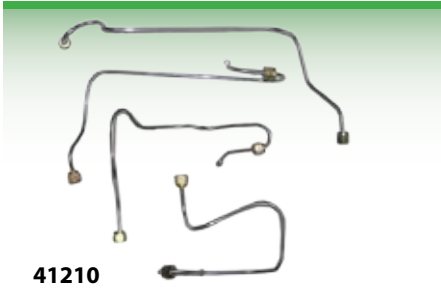

41210
Injector Pipe Set Ford 6610 - SET 4 for
Sims Pump (Set of 4)



41208
Injector Pipe Set Ford 5000 - SET 4 for
Bosch Pump (Set of 4)

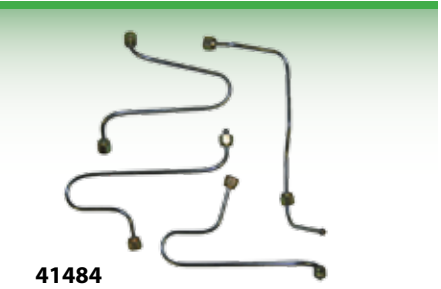

41484
Injector Pipe Set Super Major

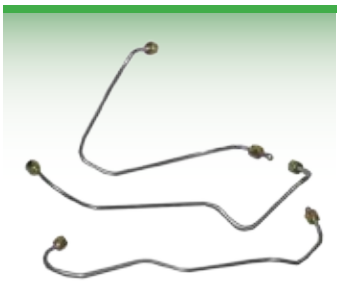

41211
Injector Pipe Set Ford 2000
3000 3600 - SET 3 And fits
3610 for Bosch Pump (Set
of 3)



41209
Injector Pipe Set Ford 5000
- SET 4 for Sims Pump (Set
of 4)



4688
Leak Off Pipe Ford 5640
6640 7740



43302
Fuel Pipe Leak Off Ford
5110 5610 6610 6710
6810 7410 7610 7710 6600 7600
[OE Ref: 83925431](#)

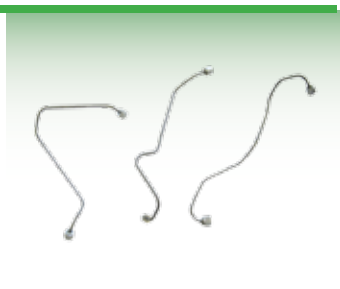

42134
Injector Pipe Set Ford 4000 -
Set 3 3 Cylinder

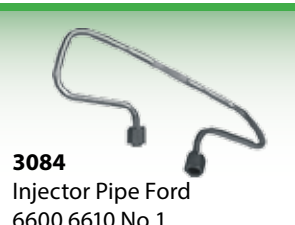

3084
Injector Pipe Ford
6600 6610 No 1



3083
Injector Pipe Ford
6600 6610 No 2

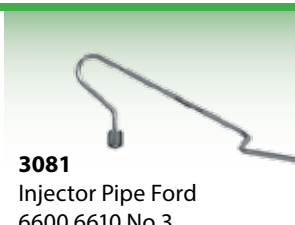

3081
Injector Pipe Ford
6600 6610 No 3

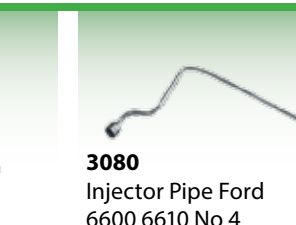

3080
Injector Pipe Ford
6600 6610 No 4



4350
Injector Pipe Ford
5000 - 7000 No 1

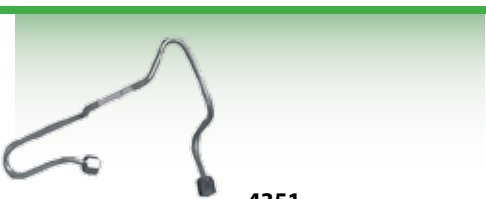

4351
Injector Pipe Ford
5000 - 7000 No 2



4353
Injector Pipe Ford
5000 7000 No 4

Fordson Dexta Fuel System

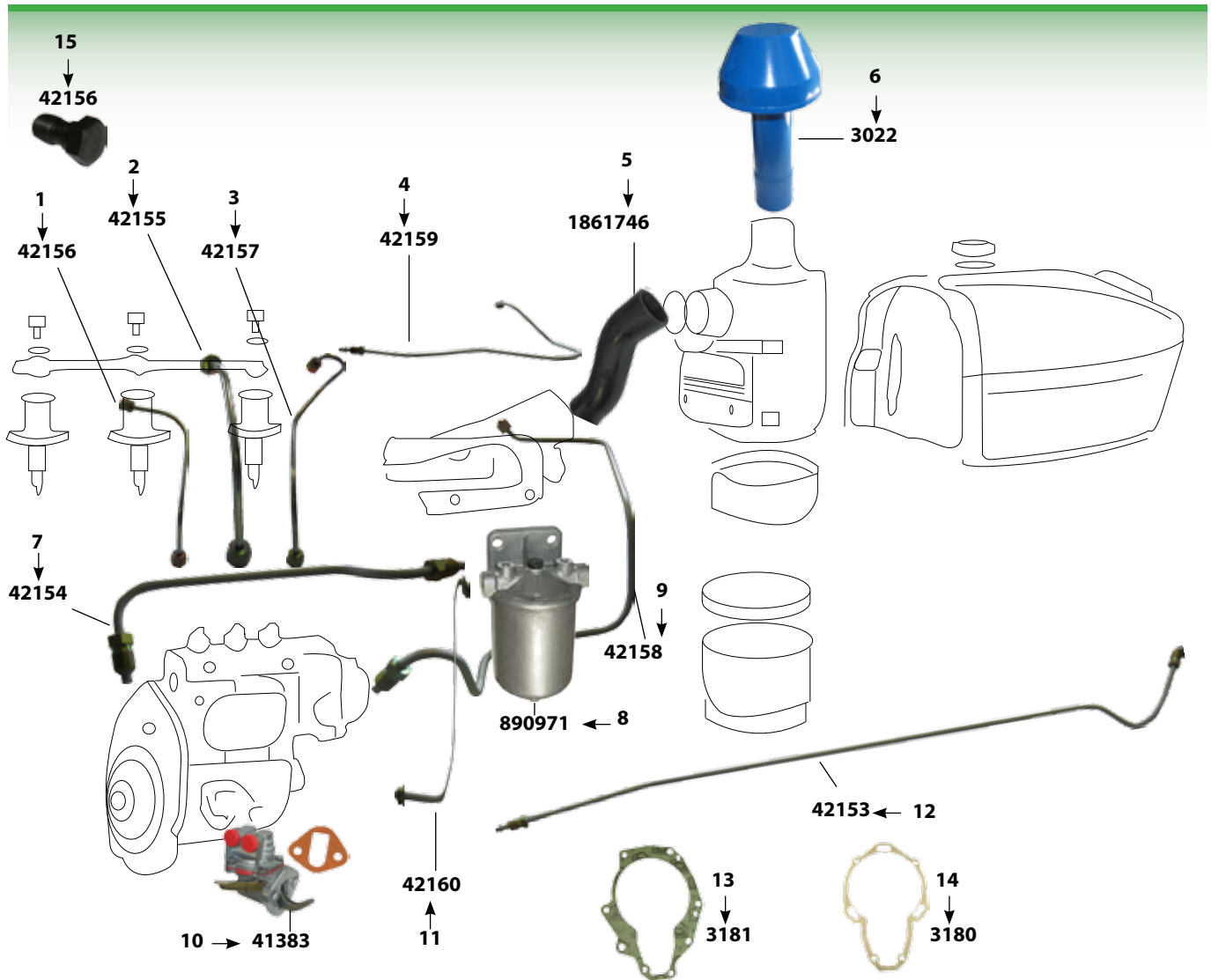

- 1 42156**
Injector Pipe Dexta - No 2
1957 - 1962
- 2 42155**
Injector Pipe Dexta - No. 1
1957 - 1962
- 3 42157**
Injector Pipe Dexta Rear - No. 3
1957 - 1962

- 6 3022**
Air Filter Hat Ford 2000
3000 - 54 x 7" Pipe **54mm
diameter** Pre Cleaner
- 7 42154**
Fuel Pipe Dexta Filter to
Injection Pump Oute 1957
- 1962
- 8 890971**
Fuel Filter Assembly 35X
Fordson Major Dexta

- 11 42160**
Fuel Pipe Dexta Filter to
Injection Pump Inne Inner
1957 - 1962
- 12 42153**
Pipe Dexta Tank To Pump
Year 57 - 62
- 13 3181**
Fuel Pump Gasket Simms

- 4 42159**
Fuel Pipe Dexta Leak Off Rail
to Tank 1957 - 1962
- 5 1861746**
Air Cleaning Hose 135 Dry
1438 Dexta Super Dexta

- 9 42158**
Fuel Pipe Dexta Injection
Pump to Inlet Manif
- 10 41383**
Fuel Lift Pump Dexta

- 14 3180**
Fuel Pump Gasket Simms
- 15 42943**
Injector Banjo Bolt Dexta

Injector Pumps



3233F380
Injector Pump Ford 3000
3600



3233F661
Injector Pump Ford 2000 2310
2610 2810 2910



3233F390
Injector Pump Ford 4000
4600



3249F951
Injector Pump Ford 5000
6600 6700

43036
Flange Injector
Pump Ford



42243
Injector Ford TS80
5610 5640 6640



43233
Diaphragm Injector Pump Major Power Major
Sup Major [OE Ref: 81714474](#)



INJECTORS
2000, 3000, 4000,
5000, 7000 SERIES

43262	4000 Series	C5NE9F593C
43263	5600 5700 3610 3910	D9NN9F593BA
43264	2000 3000 5000	D0NN9F593A
43265	7600 7700	D4NN9F593C

Fuel Filter Assembly & Parts



41752
Buffer Injector
Pump Major /
Super Major

41533
Rubber Gasket for
Glass Bowl



41528
Glass Bowl
for Lift Pump
Fordson
Major



41458
Fuel Lift Pump Super
Major c/o Glass Bowl



3044
Hand Primer
Pump Ford



41383
Fuel Lift Pump
Dexta



4659
Fuel Lift Pump
Major



43204
Fuel Lift Pump Ford D
Series Fordson Major &
Combines



2641478
Fuel Lift Pump 165 188
Ford 2000 -7600 2 Stud
Simm's Pump*



7571
Fuel Lift Pump Fiat 55 to 80-90
480 - 780 L60-L95 JX60-JX95
3435 - 7635 ** Not for TL100 **



41875
Fuel Tank Strap Ford TM120 - TM155 716mm



41920
Fuel Pipe Olive Ford
2600-7810 40's TW TS90-
TS115 8360-8560

Fuel Filter Assembly & Parts

 <p>409660 Fuel Tank Cap Ford 40 Auxillary (91-98)</p>	 <p>2775 Fuel Tank Cap Ford 7610</p>	 <p>59840 Fuel Tank Cap John Deere 00 10 20 Lockable JCB Fasttrac Teleporter Case MX & MXM Series</p>	 <p>59436 Fuel Tank Cap John Deere 00 10 20 No Lock JCB Fasttrac Telehandler Claas Axion Celtis Massey 43 54 64 74 84 Series Case MX & MXM</p>
--	--	--	--

 <p>4079 Fuel Tank Cap Ford - All Models</p>	 <p>41473 Fuel Tank Cap Super Major</p>	 <p>42240 Fuel Tank / Radiator Cap Dexta , Major</p>	 <p>41925 Seal Fuel Sender Ford 40 Series</p>
--	---	---	---

 <p>41924 Locking Ring Tank Ford</p>	 <p>1183 Fuel Tank Connection Ford 10 40 With Auxillary</p>	 <p>41568 Fuel Tap Brass 2/3/4/5/7000 Fits 2636/46/56/66/ 7600 3900 4100 57/6700 5900 7600 7700 Dexta Major</p>	 <p>1426 Fuel Tap Gauze Ford Push On Type ** Suits 41568 ** Screw Type is 43025 **</p>  <p>43025 Fuel Tap Gauze Screw In Type Ford ** Push in Type is 1426 **</p>
--	---	--	---

 <p>41050 Fuel Tank Ford 2000 3000 3600 3610</p>	 <p>41319 Fuel Tank Ford 4000</p>	 <p>4726 Fuel Tank Ford 5000 6600 6610 ** Wont Fit Q Cab **</p>
--	--	---

 <p>43014 Fuel Pipe Tank To Tank Ford TM115 TM190</p>	 <p>41691 Foot Throttle Kit Ford 5000 Also fits Ford 6600 6610</p>	 <p>41690 Foot Throttle Kit 2000 - 3610 4000</p>
---	--	--

TS/TM/M Fuel Pumps



409709
Fuel Lift Pump Electric Ford TS TM M c/w Filt MXM ** Glass Bowl Assy is 409704 **



409790
Fuel Lift Pump Electric Ford TS/TM/M Case MXM
LB90 LB110 LB115 555E 655E 675E



409704
Fuel Filter Glass Bowl Ford All Models 8160 8560 M TM ** Complete Pump is 409709 **



409790R
Fuel Lift Pump Electric Ford TS/TM/M Case MXM



409789
Seal Kit Ford TS TM M For Under Pump



409700
Fuel Filter Pump Loom Ford - New Type



42067
Fuel Lift Pump Ford T4 T5 T6 TLA TSA Case JXU



61707
Fuel Filter Head Blanking Plug All Models
1/2" UNFOE Ref: D1NN9N086A



404676
Hand Primer Pump Ford 40
sell kit 41789



41789
Fuel Filter Assembly Ford 40 c/o Hand Primer KIT - Made from 1 x 404676 & 1 x 3082



41613R
Fuel Lift Pump Ford 60 M TM110-140 Electronic



41613
Fuel Lift Pump Ford 60 M TM110-140 Electronic

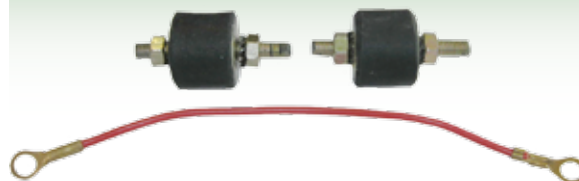

53133
Mounting Kit Fuel Lift Pump TM110 - 1140
** Suits 41613 & 41613R **

42995
Adaptor Pack To Suit 41613R

Pull To Stop Cables

Thread Ø= 9.15 mm
Overall length =1105 mm
Outer cable=895 mm

6492
Stopper Cable 690 698T 965mm

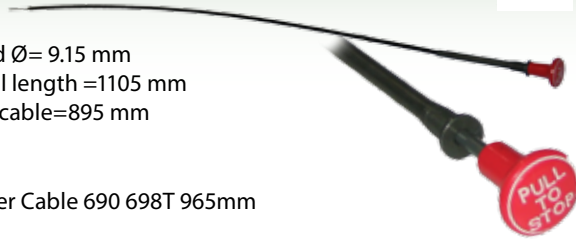

Thread Ø= 11 mm
Overall length =1600 mm
Outer cable=1315 mm

6694
Stopper Cable 2000 1.15mtr - Screw In End
2620 2625 2640 2645 2680

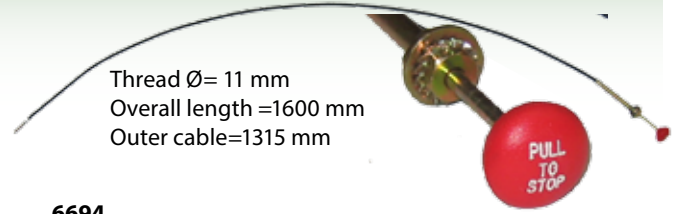

Thread Ø= 15.5 mm
Overall length =1440 mm
Outer cable=1230 mm

6073
Stopper Cable 390 1.2mtr



Thread Ø= 15 mm
Overall length =1590 mm
Outer cable=1390 mm

4112
Stopper Cable Ford 5000 7000
- 1.5mtr 4 Cylinder For Q cab



Thread Ø= 12 mm
Overall length =1400 mm
Outer cable=1130 mm

4344
Stopper Cable Ford 3 Cylinder
1.4mtr

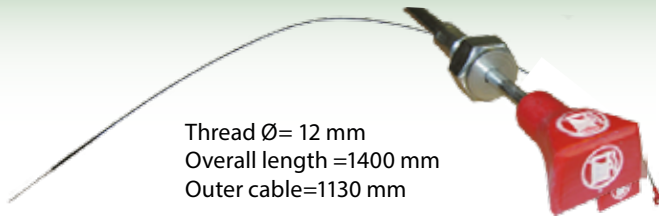

Thread Ø= 9.70 mm
Overall length =1550 mm
Outer cable=1260 mm

1031R
Stopper Cable 1.5mtr - Red Knob



Thread Ø= 15 mm
Overall length =1560 mm
Outer cable=1260 mm

1031
Stopper Cable Thread 10mm Overall
Length1560m



Thread Ø= 11 mm
Overall length =1700 mm
Outer cable=1400 mm

4806
Stopper Cable Red T Handle 1.5mtr



Pull To Stop Cables

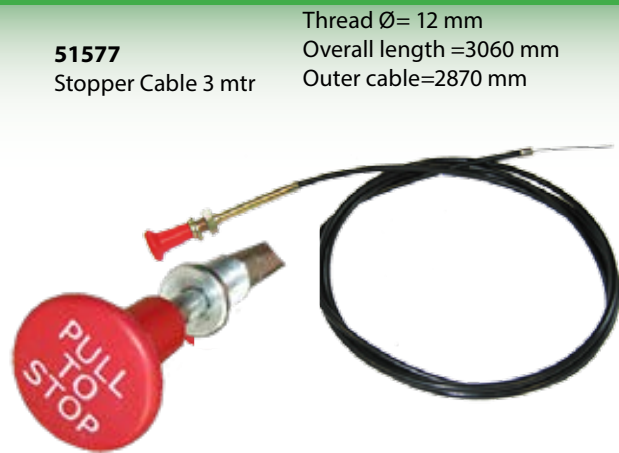
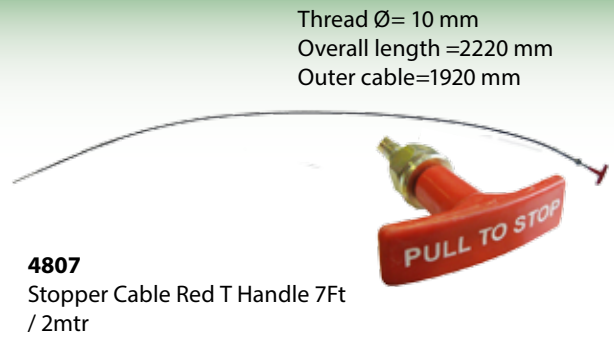
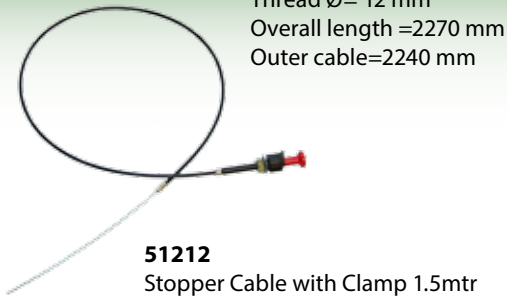

Cable End Clamps

51956
Cable End
1/4" (6mm)



51957
Cable End
9/32" (7mm)



51959
Cable End
11/32" (9mm)



51958
Cable End Assortment Pack
of 25
1/4" x 3/8", 11/32" x 1/2",
9/32" x 1/2"



41544
Nut & washer Stop Cable Ford 50
6600 6610



Cables

Rev Counter

Overall length =1110 mm
Outer cable=1020 mm



4211
Rev Counter Cable Ford
7610 Super Q 5110 5610
6410 6610 6710 6810 7610
7710

Overall length
=1250mm



3212
Rev Counter Cable Ford
3000 4000 1250mm Also
fits 5000 6000 7600 4610
5610 6610 7610 Q Cab



42229
Rev Counter Cable
Ford 7810 - 8210 TW
30s Super Q Cab



43558
Drive Cable Ford 4835 4635
7635 6635 5635 TL70 TL80
TL90 TL100 Fiat 65 75 85 95
OE Ref: 5178454

Overall length
=110 mm



3361
Rev Counter &
Speedo Extension
Ford

Throttle Cable

Thread Ø= 7 mm
Overall length =600 mm
Outer cable=530 mm



4360
Throttle Cable Ford 3 4 Cyl AP Q
Cab Short Short 600mm

Thread Ø= 10 mm
Overall length =850 mm
Outer cable=700 mm



409803
Foot Throttle Cable Ford 5640 - 7740ng

Thread Ø= 10 mm
Overall length =1490 mm
Outer cable=1380 mm



42039
Hand Throttle Cable
Ford 60 M TM

Thread Ø= 8 mm
Overall length =1774 mm



404991
Hand Throttle Cable Ford TS90
100 110 115 1774mm

Thread Ø= 19 mm
Overall length =1050 mm



404992
Foot Throttle Cable Ford TS90 100
110 -m

Overall length =560mm



41825
Hand Throttle Lever Ford Chrome
All 1000 Series2000 3000 4000
5000 7000



43281
Throttle Cable Ford New Holland
T6000 T6030 -T6070 TS100A
TS115A TSA Delta TS115A TS110A
TS130A

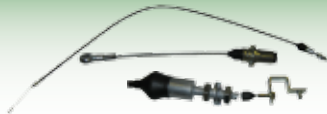

42230
Foot Throttle Cable
Ford 60 M TM Series



42133
Foot Throttle Cable Ford TS115
Overall Length 1300mm



42132
Foot Throttle Cable Ford TS115
Early

Overall length =1470mm



4268
Throttle Cable Foot & Hand Ford 10 Super
Q 5110 5610 6410 6610 6710 7610 7710 7810
7910 8210 8530 8630 8730 8830 TW15 TW25

Overall length =1790mm



409804
Hand Throttle Cable Ford
5640 - 7740 1790mm

404855

Ford 40's Foot Throttle Cable 990mm Long



404856
Hand Throttle Cable Ford 40 -1940mm
Suits 16 x 16 transmission

Engine Parts

43313

Sump Ford 5640 6640 7740
7630
OE Ref: 81866343



43314

Sump Ford
5610 6410 6610 6710 6810 7410
7610 7710 5600 5700 5900 6600
6700 7600 7700 4000 5000 7000
7100 7200 5030 OE Ref: 83936297



3858

Balancer Unit Ford 10's
(Gear Ref D8NN6B302AB)



1937

Head Stud Kit Ford
6610 7610

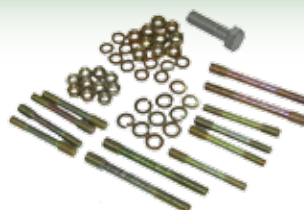

2091

Timing Cover Bolt
Kit Ford 6610 7610

2498

Engine Block Plug 4
Cylinder



3326

Timing Cover Seal Ford
7610 7840 60.3 x 82.7
x 12



2302

Idler Gear Hub to suit
New Block Ford



2283

Seal & Gasket Kit Rear
Crankshaft Ford 7610 7840
c/o Genuine Seal



2269

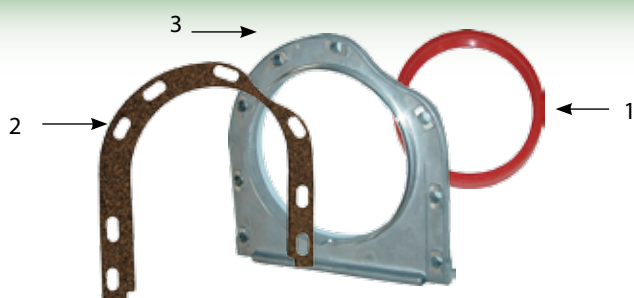

Seal & Gasket Kit Rear
Crankshaft Ford





1. **2074** 56/6600 Rear C/S Oil Seal
- 1A. **2074G** Gen 56/6600 Rear C/S Oil Seal
2. **1929** 7610 Rear Crankshaft Gasket
3. **2301** 10'S Rear Oil Seal Retainer Plate

Engine Parts & Frost Plugs

			
<p>41468 Inlet Valve Seal Super Major</p>	<p>41461 Injector Seal Super Major</p>	<p>41535 Seal Major for Injection Pump</p>	<p>41464 Auxiliary Drive Seal Major 18 X 37</p>





		
<p>48804 Fordson N's 6 Volt Coil 2N/8N/9N/ Front Mounted Distributor</p>	<p>4280 21mm Frost Plug 4083 22mm Frost Plug 3959 29mm Frost Plug 4084 38mm Frost Plug 4085 40mm Frost Plug 4086F 44mm Frost Plug (Long Type) 41692 41.27mm Frost Plug</p>	<p>53654 Frost Plug Kit 7/8" 1 1/2" 1 9/16" 1 3/4"</p>

	
<p>41524 Front Crank Seal Ford Dexta Super Dexta</p>	<p>48802 Tuning Kit Fordson N's (Front Mnted Dist) 2N/8N/9N (Front Mounted Distributor</p>



		
<p>41439 Valve Tappet Major</p>	<p>31134151 Bush 35 65 135 165 203 Small End Conrod Bush Dexta Super Dexta</p>	<p>41463 Cylinder Head To Block Seal Major</p>



		
<p>4080 Oil Filler Cap Ford Engine/Transmission</p>	<p>41225 Engine Oil Filler Cap Dexta / Super Major Dexta/Super Dexta/ Fordson/ Fordson SuperMajor</p>	<p>43311 Oil Filler Cap Ford 5640 6640 7740 7840 8240 8260 8360 8560 OE Ref: 81866214</p>
		<p>43549 Engine Oil Cap Ford New Holland 10s 1000s 30s 40s Engine Oil OE Ref: 81823295</p>

Pistons & Rings

<p>41023 Liner Major Engine 100mm (1961-1965) Double Groove</p> 	<p>41113 Liner Seal Super Major (5mm)</p> 	<p>41576 Liner Seal Major Super Major (2.9mm)</p> 	<p>41110 Liner Major Super Major - 100mm Bore (1957-1961) Single Groove</p> 	<p>41112 Liner Seal Major for 41110 Liner (5mm)</p> 
--	--	--	--	--

<p>61899 Liner Dexta P3-144 Perkins Engine</p> 	<p>41024 Liner Ford Semi Finished 4.4</p> 	<p>41060 Piston & Pin Power/Super Major (100mm) Major 1957-1965</p> 
---	--	---

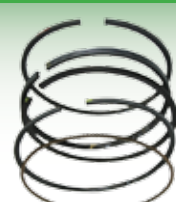
<p>41322 Piston Ring Major Standard 100mm</p> 	<p>41322 Piston Ring Major Standard 100mm</p> 	<p>41622 Piston Rings Dexta (3.5")</p> 
--	--	--

<p>4090 Ring Ford 4000 5000 6600 Standard Set of 3 Rings per Piston</p> 	<p>42966 Ring Set Ford 6810 7410 7610 (8/87>) 7710 (8/87 >) OE Ref: DFPN6149E</p> 	<p>42963 Ring Set Ford 3000 5000 (-> 3/68) 3100 3300 3600 3900 5100 (-> 3/68) 5200 5600 (->9/80) 5700 (->9/80)</p> 	<p>42951 Piston c/o Rings Ford 3000 5000 (-> 3/68) 3100 3300 3600 3900 5100 (-> 3/68) 5200 5600 (->9/80) 5700 (->9/80)</p> 
--	--	--	---

<p>41081 Piston Kit Early 7000 (4 per Kit) ** 17mm to top of first ring** 41080 is late</p> 	<p>41250 Piston & Ring Assembly Ford 6600 (Singles)</p> 	<p>41251 Piston & Ring Assembly Ford 6610 (Singles)</p> 	<p>42954 Piston c/o Rings Ford 5000 (4/68->) 5100 (4/68 ->) 5200 (4/68 ->) 5600 (10/80 - 5900 -> 7/87) 6600 (->9/80) 6700 (->9/80)</p> 
---	--	---	---

Engine Kits



43219
Engine Kit Fordson Dextra



43220
Engine Kit Fordson Super Dextra

COMPONENTS - FORDSON DEXTA, SUPER DEXTA

43208

Piston Fordson Dextra 88.92 Bore



50044

43209

Ring Set Fordson Dextra

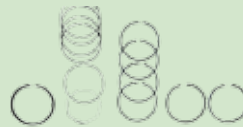

745823M91

43210

Liner Fordson Dextra



81803819

43214

Liner Fordson Super Dextra Unfinished

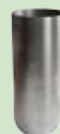

81803820

ENGINE KITS - FORDSON MAJOR, POWER MAJOR, SUPER MAJOR

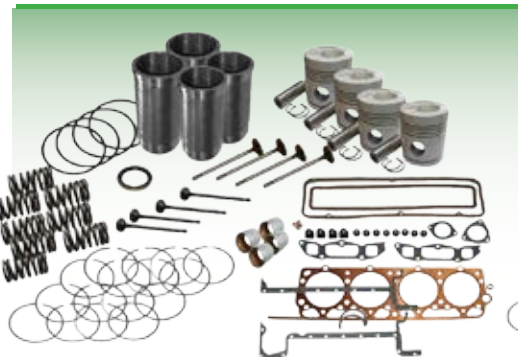

43221 Engine Kit **Fordson Major**



43222
Engine Kit **Fordson Power Major**

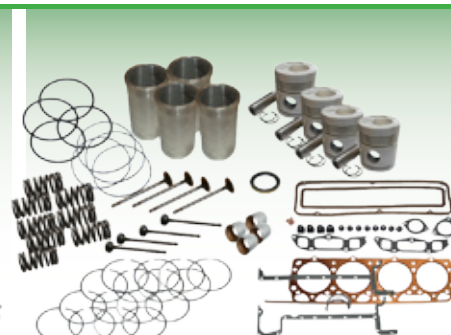

43223
Engine Kit **Fordson Super Major**

COMPONENTS - MAJOR, POWER MAJOR, SUPER MAJOR

43215 Conrod Bush Fordson Major Power Major Super



[E1ADKN6207B](#)

43216 Valve Spring Fordson Major Power Major Super



[E1ADDN6513](#)

43217 Exhaust Valve Fordson Major Power Major Super



[723F6505ABA](#)

43218 Inlet Valve Fordson Major Power Major Super



[E1ADDN6507](#)

41060 Piston & Pin Power/Super Major (100mm)



[81710338](#)

41107 Piston & Pin Fordson Major 100mm 1952-1956



[E1ADDN6110J](#)

43289 Big End Bearings Ford Major Power Major Super Major



[81854542 x 4](#)

Engine Parts

41217
Ring Gear Dexta / Super
Dexta A3.144 A3.152



41476
Ring Gear Fordson Major
Flywheel



42247
Crankshaft Major Super Major
c/o Bearings

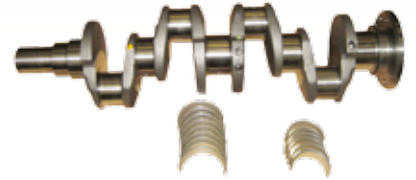

42893
Crankshaft Super Dexta 2000
3000 4.2" Stoke



42894
Crankshaft Ford 4000 4600
4610 4.4" Stroke



42895
Crankshaft 5000 5600 5610 6600 7000
7600 7700 7610 7710 78 Teeth Gear 4.2"
Stroke



42897
Crankshaft Ford 6600 6700 7600 7700 7610 5600
5610 7710 78 Teeth Gear 4.4" Stroke



42896
Crankshaft 5610 6610 6710
7410 7610 7710 76 Teeth
Gear 4.4" stroke



Big End Bearings 000/00/10 Series

Early Type (36mm)

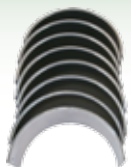

42924	Standard
42925	10 Thou
42926	20 Thou
42927	30 Thou

Late Type (32mm)



42932	Standard
42933	10 Thou
42934	20 Thou
42935	30 Thou

Main Bearing Kit 000/00/10 Series



42928	Standard
42929	10 Thou
42930	20 Thou
42931	30 Thou

Main End Bearings Major

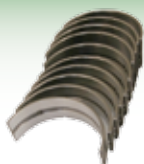

42920	Standard
42921	10 Thou
42922	20 Thou
42923	30 Thou

Engine Parts

42953

Piston c/o Rings Ford 2000 5000
7000 2100 2300 3100 3300 3600
4100 4200 4400 4600
OE Ref: 81877564



42952

Ring Set Ford 2000 5000 70002100 2300
3100 3300 3600 4100 4200 4400 4600
OE Ref: 81814543

42962

Piston c/o Rings Ford 5610 6610 6810
7010 (850179M>) 7610 5640 6640 7740
8160 8260 8360 Turbo 8560 Turbo TS100
TS110 TS80 T Turbo TM115 125 135
150 165 Fiat M135 M160 OE Ref:
87800435



43618

Liner TS80 TS90 TS100 TS110 TS115 8160 8260
8360 8560 TM110 TM115 TM120 TM125 TM130
TM135 TM140 TM150 TM155 TM165 TM175
OE Ref: 83998292



42961

Ring Set Ford 5610S 6610S 6810S7010
(850179M>) 7610S 5640 6640 7740 8160
OE Ref: 81866003



42956

Piston c/o Rings Ford 3100 3300 3600
3900 5100 (3/68>) 5200 (3/68>) 5600
(9/80>) 3000 5000 (3/68>) 3310 3150 5700
(9/80>)
3190 5190 (3/68>) OE Ref: 81817957



42955

Ring Set Ford 3100 3300 3600 39005100
(3/68>) 5200 (3/68>) 5600 (9/80>)
OE Ref: 81814535

42959

Piston c/o Rings Ford 6810 7410 7610
(8/87>) 7710 (8/87>)
OE Ref: 83960635



42966

Ring Set Ford 6810 7410 7610
(8/87>)7710 (8/87 >)
OE Ref: DFPN6149E



42960

Piston c/o Rings Ford 7010
7610S 77408340 Turbo
OE Ref: 81873456



43589

Piston Ford 40 Series c/o Rings
OE Ref: 87801070



42958

Piston c/o Rings Ford 6410 6610
(8/87>) 6710 (8/87>)
OE Ref: 81877565



42957

Piston c/o Rings Ford 6610
(7/87>) 6710 7810 7910
(4/86>) 8210 (4/86>) TW5
(4/86>) 4600 (Non Headland)
6600 (10/80>) 6700 4630 (Non
Headland) 8530 (4/86>)
OE Ref: 81877563

NEF Engine Parts



Q87317238
Piston Assy Non Turbo Standard
NEF Iveco Engine Case New
Holland TL80A TL70A C190
OE Ref: 87317238



Q87316211
Ring Set Non Turbo Standard
NEF Iveco Engine Case New
Holland TL70A TL80A C190 L180
OE Ref: 87316211



Q87317243
Piston Assy Non Turbo
0.40mm NEF Iveco Engine
Case New Holland C190 L190
OE Ref: 87317243



Q87316213
Ring Set Non Turbo 0.40mm
NEF Iveco Engine Case New
Holland C190 L190
OE Ref: 87316213



Q8094740
Piston Assy Turbo Standard
NEF Iveco Engine Case New
Holland TSA T4000
OE Ref: 8094740



Q8094845
Ring Set Turbo Standard
NEF Iveco Engine Case New
Holland T4000 T5000 T6000
T9000
OE Ref: 8094845



Q87317252
Piston Assy Turbo 0.40mm NEF
Iveco Engine Case New Holland
T6000 C185 LT185 L185
OE Ref: 87317252



Q87316944
Ring Set Turbo 0.40mm NEF
Iveco Engine Case New Holland
T6000 C185 LT185 L185 LS185B
OE Ref: 87316944



Q2995787
Main Bearing Standard NEF
Iveco Case New Holland T6000
T7000 C190 L190
OE Ref: 2995787



Q2995788
Main Bearing 0.254mm NEF Iveco
Engine Case New Holland T6000
T7000
OE Ref: 2995788

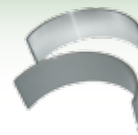

Q8093882
Rod Bearing Standard NEF
Iveco Engine Case New Holland
T4000 T5000 T6000 T7000
OE Ref: 8093882



Q8094960
Rod Bearing 0.254mm NEF
Iveco Engine Case New Holland
T4000 T5000 T6000 T7000
OE Ref: 8094960



Q2995784
Thrust Bearing Standard
NEF Iveco Engine Case New
Holland T6000 T7000
OE Ref: 2995784



Q2995785
Thrust Bearing 0.254mm
NEF Iveco Engine Case New
Holland T6000 T7000 TM7000
OE Ref: 2995785



Q4890832
Seal Front NEF Iveco Engine
Case New Holland T4000 T5000
T6000 T7000 LM
OE Ref: 4890832



Q4890833
Seal Rear NEF Iveco Engine
Case New Holland
OE Ref: 4890833



Q4897480
Oil Pump NEF Case New
Holland T6000 C190 L190
OE Ref: 4897480



Q4897481
Oil Pump NEF Case New
Holland T6000 CR5080
OE Ref: 4897481



Q2830559
Gasket Oil Cooler NEF Ford
TN85A T7030 T6030 T6050
TS115A TS130A TN95A
TL100A, T6040, T6020, TS110A
TL80A T6010 T705



Q2852743
Gasket Exhaust Manifold NEF
Ford TN85A T6030 T6050
TS115A TS130A TN95A TL100A
T6020 TS110A TL80A T6010
T6070

Engine Parts



2094
Gasket Ford
7610 Turbo



2106
Gasket Ford 7610
Turbo



2105
Gasket Ford 7610
Turbo



1981
Exhaust
Clamp Ford
7610 Elbow
to Turbo



2565
Clamp Ford 7840
8360 Turbo TW15
TW20 TW25 TW30
TW35 8730 8830



41883
Gasket Turbo Ford TM120 -
TM190



7805
Dipstick Fiat L95



4119
Dipstick Ford 2600 - 7600 Engine



3331
Dipstick Short 2000 3000 4000 5000 Engine



4173
Dipstick Ford 5000 7000 Short (Engine)

Engine Parts

3127

Conrod Bush Ford Non Turbo 2000 3000
4000 5000 6600 6610



51970

Conrod Bush Tapered Ford 7610 7810 TW
5110 5610 6410 6610 6710 7410 7610 7710
7810 7910 8210 8530 8630 8730 8830 5640
6640



43586

Bush Small End Conrod Ford 5110 5610
6410 6610 6810 7410 7610 7710 7810 7910
8210 7600 7700 8200 8600 8700 9200 9600
9700 TW10 TW15 [OE Ref: 81819460](#)



409872
Conrod Ford 6610



42085
Conrod Ford M TM
60



2938
Flywheel Ford 7600 7610 13"



3325
Ring Gear Ford 2000 - 7600 - 128
Teeth 7610 - 8210 40 Series TS TM



4159
Flywheel Bolt Ford
(all models)



43695
Oil Cooler Pipe Ford 2310
2610 2910 3910 4110
[OE Ref: D5NNL902A](#)

4810

Short Block Front Pulley
Key Ford 7610



3061

Valve Steam Seal
Ford 4 Cylinder



41134
Camshaft Push
Rod Ford 10 L TW

4139

Washer Sump Plug
Ford 3/4" ID

4174

Sump Plug Ford & 135
(3/4'-16 Thr) Fits Ford
7610 8210 TM TS TW &
CASE MXM

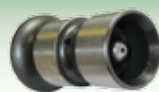

42212
Valve Tappet Ford TM
TS



43156
Valve Exhaust Ford 7740
8340 8360 8560 8670 8770
8870 TS100 TS110 7630 Case
MXM120 MXM130 MXM135
MXM140 MXM150 Fiat G170
G190 G210
[OE Ref: 81865088](#)



43157
Valve Inlet Ford 7740
8770 8870 8970 TS100
TS110
[OE Ref: 81865095](#)

Engine Parts

Oil Pumps & Parts



3327
Oil Pump Ford 2000 3000 4000
5000

3328
Oil Pump Ford 7000 7600

42883
Oil Pump Ford 30 35 L
TD TN TL Series Fiat 40
50 80 90 94 L Series

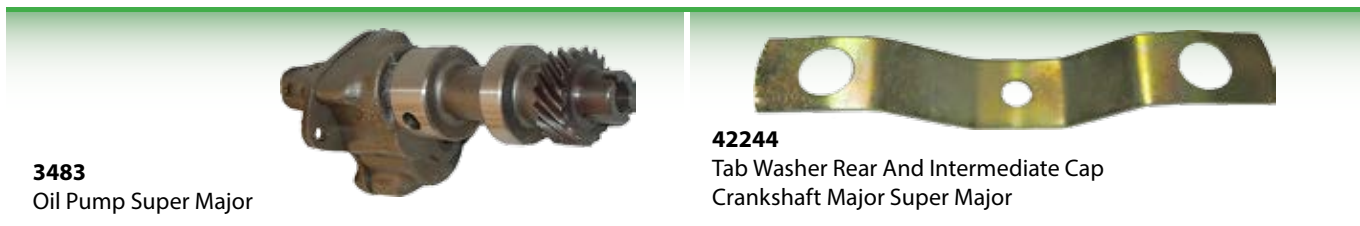

3483
Oil Pump Super Major

42244
Tab Washer Rear And Intermediate Cap
Crankshaft Major Super Major



3329
Oil Pump Shaft & Gear
Assembly 7810 Major
Ford 7810/8/8600

3738
Oil Pump Ford 8210
TW 10 20 25

3739
Oil Pump Ford 7810 8000 8600

42964
Oil Pump Ford 800 8600 9000
9200 9260

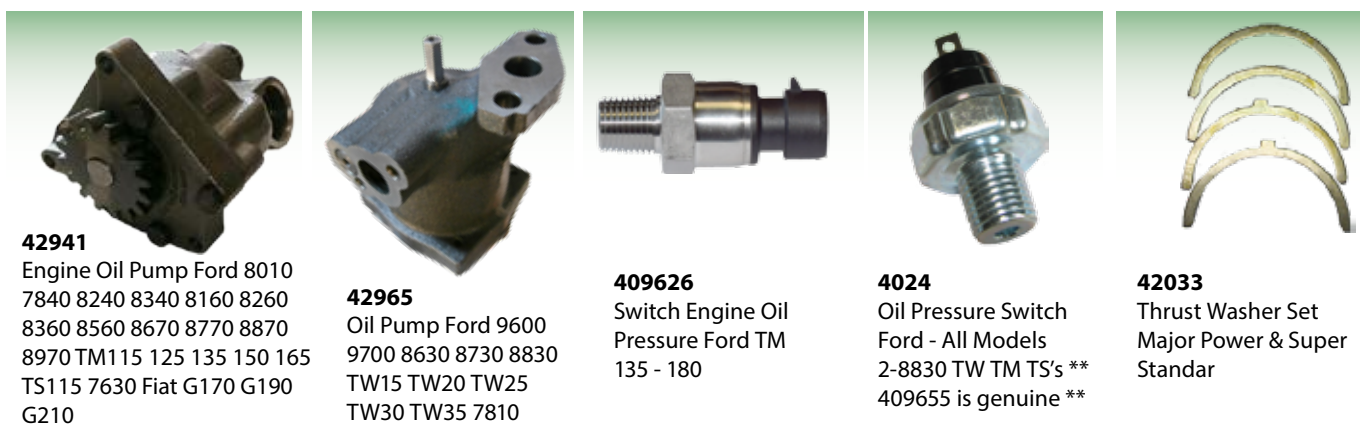

42941
Engine Oil Pump Ford 8010
7840 8240 8340 8160 8260
8360 8560 8670 8770 8870
8970 TM115 125 135 150 165
TS115 7630 Fiat G170 G190
G210

42965
Oil Pump Ford 9600
9700 8630 8730 8830
TW15 TW20 TW25
TW30 TW35 7810

409626
Switch Engine Oil
Pressure Ford TM
135 - 180

4024
Oil Pressure Switch
Ford - All Models
2-8830 TW TM TS's **
409655 is genuine **

42033
Thrust Washer Set
Major Power & Super
Standar



41224
Oil Pump Shaft Fordson /
Super Major

3330
Oil Pump Shaft Ford - All
Models Pencil Drive

409655
Oil Pressure Switch Ford Also
fits TS90-115 & TS100A-135A

3675
Ford Oil Pump Gasket



Date:.....

No. of Pages:.....

Name of the Rep.....

A/C Number:.....

From:.....

e-mail.....

Phone No.:.....

Fax No.:.....

Please quote for the following parts - Quotation Number :

I wish to confirm the following order on Quotation Number:

Please supply the following parts:

Qty	Part No.	Description	Unit Price
1.			
2.			
3.			
4.			
5.			
6.			
7.			
8.			
9.			
10.			
11.			
12.			
13.			
14.			
15.			
16.			
17.			
18.			
19.			
20.			
21.			
22.			
23.			
24.			

Please photocopy this page

Please do not remove this page

Comments:

Customer Signature:

Rep's Signature:

Tel No: + 353 44 934 1638

e-mail: info@qtponline.com, www.qtponline.com

Page of

Exhausts

43205
Exhaust Ebro
Super 55



1415
Exhaust Dexta & Super Dexta
Silver

Clamp =3283



41729
Exhaust Ford Pre Force - 2 Piece

Cap =51807
Clamp =3067

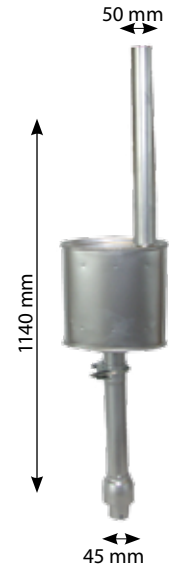

41056
Exhaust Ford Major Silver
**Universal White/Oliver Fiat
450 - 640** Also Super Major
Power Major

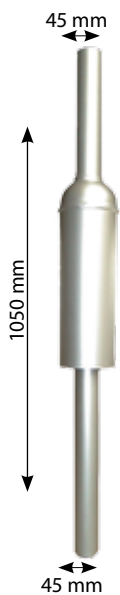

3244
Exhaust Ford 2000 3000 4000
5000 Black Enamel

Cap =51807
Clamp =4137



3248
Exhaust Ford 2000 3000
4000 5000 Silver Heat
Resistant

Clamp =3067

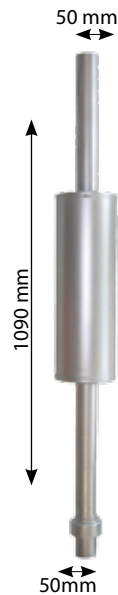

3245B
Exhaust Ford 4600 - Black
Paint Bottom Pipe 46mm
diameter 2600 2610 3600
3610 4600 4610

Clamp =1633



Exhausts

3246C

Exhaust Ford 6600 Swan Neck Heat Resistant Black Paint

Clamp = 4137

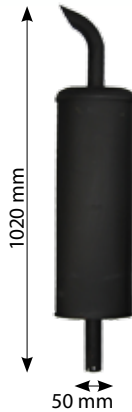

3247B

Exhaust Ford 7000 7600 5610 6610 7610 7710 7810 County ** with Bent Pipe ** Also 8210 from 82 to 85 OE Ref: 87704570



Heat Resistant Black Paint



3247E

Exhaust Ford 7000 7600 5610 6610 7610 7710 7810 County ** with Bent Pipe ** Also 8210 from 82 to 85

Clamp = 1633

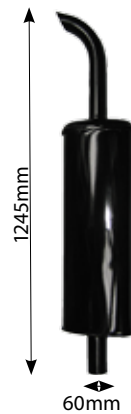

2954

Exhaust Ford TW15 8630 **2956 is for bigger TW & 30 Series** Start year 01/01/1983



2956

Exhaust Ford TW25 TW35 & 8730 8830 **2954 is for TW15 & 8630**

Clamp = 51202

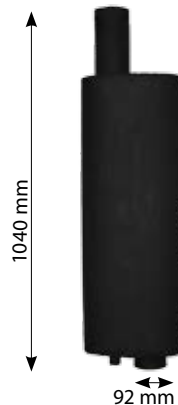

409866

Exhaust Ford 7740 7840 8240 8340 Pipe Top Enamel Also Fits TS90 - 120 (70mm id)

Clamp = 51203



43463

Exhaust Ford 7000 Turbo OE Ref: D9NNS230FA



43238

Exhaust Ford New Holland 4635 4835 5635 6635 7635 L60 L65 L75 L85 L95 T5030 T5040 T5050 T5060 TL65 TL70 TL80 TL90 TL100 TL70A TL80A OE Ref: 5173644



41114

Exhaust Ford 8360 8560 TM125 TM135 TM150 Fiat M135 M160 New Holland TM165 **41833 is for Newer TM models - it has brack

Clamp = 51202



42109

Exhaust Stack Pipe Ford TSA 115 T6020 4 Cylinder with Venturi Cab

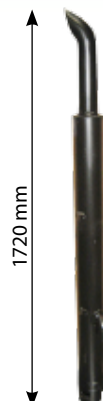

Exhausts

41558

Exhaust Box Ford 8360 - 8560 TM125 TM160 ** 42185 is TM140 Exhaust Box **



41022

Exhaust Box Ford 8160 8260 M100 M115 TM115 TM 125

Gasket = 2094



43006

Exhaust New Holland TD60 65B 70 80 90 95 Tier III TD5040 5050 TD55D 60D 65D 70D 75D 80D 85D 90D 95D TK65F 65V 75V 75M 75V 76 76M 85 85M

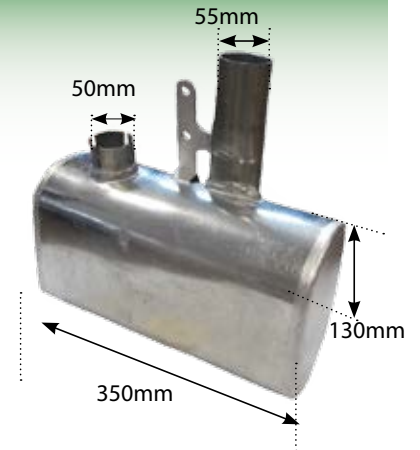

41868

Exhaust Manifold Stud Ford TM115 TM190



41556

Exhaust Screw Ford 7840



Suitable For Use On 403998, 407118, 41724, 4414

403998

Exhaust Box Ford 7840 Turbo 8340 Turbo

Pipe = 409866

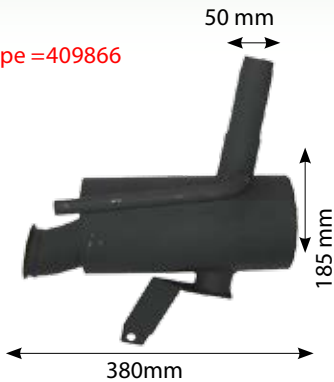

407118

Exhaust Box Ford 5640 6640 TS80 TS90 TS115 Non Turbo

Gasket = 2094
Pipe = 409866



41724

Exhaust Box Ford 5640 - 6640 Year 91-98 ** Non Turbo **

Gasket = 2094
Pipe = 409866



402334

Exhaust Box Ford 7740 TS90 - 110 From 1997

Pipe = 409866



402333

Exhaust Box Ford 7740 TS90 100 110 To Year 1996

Pipe = 409866



403990

Exhaust Box Ford 7840 Non Turbo ** 403998 is Turbo Exhaust **

Gasket = 2094
Pipe = 409866

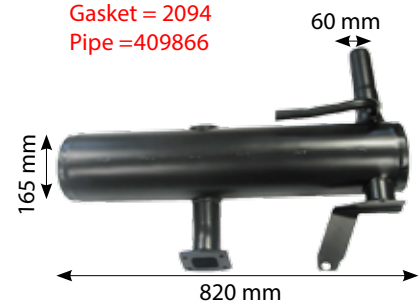

42004
Exhaust Box Ford TS115
Non Turbo For Corner
Post Only

Pipe =41809



42185
Exhaust Box
Ford TM140



43639
Exhaust Silencer Case JX New Holland
TN Series TD Series
OE Ref: 5093950



43640
Exhaust Silencer Case JX Series New Holland
New Holland TN Series TD90D
OE Ref: 5094825



43236
Exhaust Ford New Holland
TL70 TL80 TL90 TL100
JX100U JX70U JX80U
JX90U Side Mounted
OE Ref: 5182537

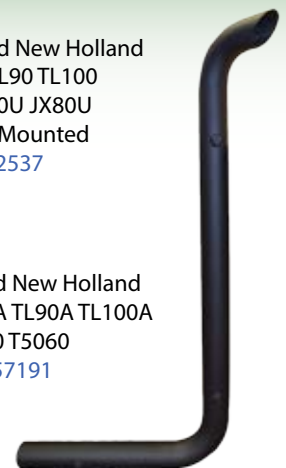

43237
Exhaust Ford New Holland
TL70A TL80A TL90A TL100A
T5030 T5040 T5060
OE Ref: 84357191

42083
Exhaust Box Ford TSA MXU Clip Type T6030
T6050 T6070 TS115A TS125A TS130A TS135A



409735
Exhaust Manifold
Stud Ford



42003
Exhaust Box Ford
TS115 Turbo *** For
Corner Post Only



42086
Exhaust Ford TSA
MXU Flat Flange
T6010 T6020 T6040
T6060 TS100A
TS110A



Engine Parts

Date:.....

No. of Pages:.....

Name of the Rep.....

A/C Number:.....

From:.....

e-mail.....

Phone No.:.....

Fax No.:.....

Please quote for the following parts - Quotation Number :

I wish to confirm the following order on Quotation Number:

Please supply the following parts:

Please photocopy this page

Please do not remove this page

	Qty	Part No.	Description	Unit Price
1.				
2.				
3.				
4.				
5.				
6.				
7.				
8.				
9.				
10.				
11.				
12.				
13.				
14.				
15.				
16.				
17.				
18.				
19.				
20.				
21.				
22.				
23.				
24.				

Comments:

Customer Signature:

Rep's Signature:

Tel No: + 353 44 934 1638

e-mail: info@qtponline.com, www.qtponline.com

Page of

Exhaust Elbows



4414
Exhaust Elbow Ford
4600 6600

Gasket=4156



4201
Exhaust Elbow Ford 6610

Gasket=2094

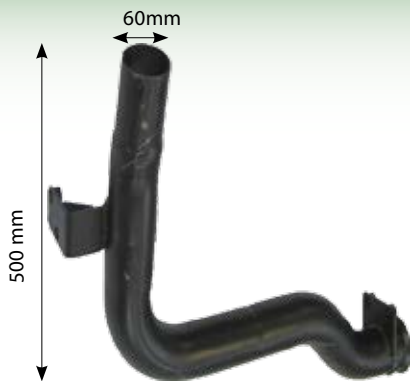

4164
Exhaust Elbow Ford
7710



4413
Exhaust Elbow Ford 7610 - Tapered
Face



4706
Exhaust Elbow Ford 7810 7910 8210
Note: This only suits 7810 from 1982
up 1987 Ford 7810 for 1988 was a
different pipe [OE Ref: E0NN5246DA](#)



2354
Exhaust Elbow Ford TW 15 20 25
30 8630 8730 8830 01/03/1990 to
01/12/1993

Exhaust Clamps & Caps

Weathercaps



51807 2" 51mm
51204 2 1/4" 56mm
51198 2 5/8" 66mm
51195 3 1/4" 82mm



62801 1 3/4" 45mm
59290 3 3/4" 100mm



3415 70mm 2 3/4"
3264 82mm 3 1/4"



61579 240 Rain Cap 43mm
3169 285 Rain Cap 60mm

Raincaps

Stainless Steel Rain Caps



53350
 1 3/4"
 44.45mm
 OD



53351
 2 1/4"
 57.15mm
 OD



53352
 2 1/2"
 63.5mm
 OD



53353
 2 3/4"
 69.85mm
 OD



53354
 3"
 76.2mm
 OD



53355
 3 1/2"
 88.9mm
 OD



53356
 4"
 101.6mm
 OD



Nylon Buffer



62121
 Exhaust Clamp 165
 - OE Type 59mm



62113
 Exhaust Clamp
 135 135 20D 148
 55mm White
 Aluminium
 Metal Spray



61298
 Exhaust Clamp
 35 135 Lower
 Horizontal



62105
 Exhaust Clamp for
 Rear View Mirror 35
 Exhaust



907155
 Washer 100 200
 Exhaust Clamp
 Square

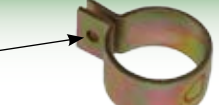

180070
 Exhaust Clamp 20 TVO
 Heavy Duty

Exhaust Clamps



61481
 5/16 Brass Nut



0826232
 Exhaust Manifold Stud 135 1
 1/2" x 5/16" Also Elbow Stud



61482
 3/8" Brass Nut



082075
 Exhaust Manifold Stud 1
 21/32 x 3/8 UNF Also Elbow
 ** 62574 is Stud & Nut **



62298
 Nut Exhaust Manifold
 FE 35 3/8 Brass UNC



62202
 Exhaust Manifold Stud
 35 FE 3/8 UNC



Part no	Dimensions	Diameter
3066	38 mm	8mm
3283	41 mm	10mm
3067	45 mm	10mm
4137	51 mm	10mm
1327	54 mm	10mm
1326	57 mm	10mm
1633	64 mm	10mm
1637	66 mm	8mm
51203	70 mm	10mm
51201	80 mm	10mm
51202	92 mm	10mm

61479
 Exhaust 20 TVO Extension
 Horizontal (2 Hole)

Gasket = 3064



61299
 Exhaust 35 135 Extension
 Horizontal

Gasket = 827877



Exhaust Manifolds



4687
Exhaust Manifold Ford Dexta
Gasket=0490481



0490481
Dexta Exhaust Manifold Gasket



41335
Exhaust Manifold Ford Major (Year 4/57-1964) (Staggered Holes)
Gasket=41219
Bolt=62202
Nut=62298



41219 Fordson/Super Major Inlet Manifold Gasket Set



41233
Exhaust Manifold Ford Major - In Line Holes
Gasket=42072
Bolt=62202
Nut=62298



42072
Exhaust Manifold Gasket Ford Major



41057
Exhaust Elbow Major
Gasket=41469



41469
Exhaust Elbow Gasket Super Major

41218
Air Inlet Manifold Gasket 35 Dexta / Super De







2149
Exhaust Manifold Ford 3000 4000
Gasket=1173 & 1173S



1173
3 Cylinder Exhaust Manifold Gasket





2933
Exhaust Manifold Ford 4610
Gasket=1173 & 1173S

1173S
STEEL 3 Cylinder Exhaust Manifold Gasket



41357
Exhaust Manifold Ford 6600 6610
Gasket=1174 & 4121



1174
4 Cylinder Exhaust Manifold Gasket





2150
Exhaust Manifold Ford 5000 Ford 5600 6600
Gasket=1174 & 4121

4121
STEEL Exhaust Manifold Gasket Ford 5600 6600

Exhaust Manifolds



Gasket
41555



43191
Exhaust Manifold Kit Ford 7840
** Short and Long Side ** TS115 6 Cylinder 8240 8340



409734 STEEL Exhaust Manifold Gasket
Ford New Type 3 & 6 Cylinder



409734R
Exhaust Manifold Gasket



43656
Exhaust Manifold Sealing Ring New Holland
7840 8240 8340 7810 8010 [OE Ref: 87802624](#)

1030
Exhaust Manifold Ford TW 10 60
Rear TW10 20 30 From '76 TW5 15 25
35 From '83

Gasket=1173 & 1173S



2365
Gasket Ford 7810 Exhaust Manifold
Turbo
Also fits TW 8210 Front+

2353
Exhaust Manifold Ford 7810 8210 TW Turbo TW10
TW20 TW30 From 76 TW5 15 25 35 From '83

Gasket=2365

1173 / 1173S
3 Cylinder Exhaust Manifold Gasket



43151
Gasket Exhaust Manifold New Holland T6020 - T6080 [OE Ref: 2853800](#)

Exhaust Manifolds

43272

Exhaust Manifold Ford New Holland 4230 4835 5635
 L65 L75 TL100 TL70 TL80 TL90 Fiat 65-66 70-66 80-66
 80-76 65-93 72-93 82-93 550 600
 OE Ref: 04606570



43620

Exhaust Manifold Case MXMs OE Ref: 87802374

Stud - 41868



409734

Exhaust Manifold Gasket New Type 3 & 6 Cylinder
 Steel Gasket
 OE Ref: 87801658



409734R

Gasket Exhaust Manifold **Made of Thick Gasket
 paper** OE Ref: 87801658

Cooling System Pumps



48823
Water Pump Ford 2N 8N 9N
c/w Pulley



41226
Water Pump Ford Dexta & Super
Dexta



3227
Water Pump Major



41477
Water Pump Pulley Super Major



4057
Water Pump Ford 6600 7600 Double
Pulley Includes the Gaskets
For Tractors WITHOUT Viscous Fan



2830
Water Pump Ford 10s
For Tractors with Viscous Fan



43668
Water Pump Ford 10s
Single Pulley
[OE Ref: 81863909](#)



42911
Water Pump Ford 35 Series L TL TN

Cooling System Pumps



42916
Water Pump Ford 1720 1920 3415 LS150
LS160 LS170 LX465 LX565 LX665 TC30D
TC33D TC35D TC40D TC45D TC48TD TC55D



42913
Water Pump Ford 1910
2110 2120



42914
Water Pump Ford 1500 1700 1900



1922
Water Pump Ford 2000 3000 4000
Single Pulley 5000 6600



2449
Water Pump Ford 7810 Only



42915
Water Pump Ford 1710



1402
Water Pump Gasket Ford (Inside) 1000s 100s 200s
300s 600s 10s 30s 40s TWs



1398
Water Pump Gasket Ford Dexta/2-5000

Cooling System Pumps



403540
Water Pump Ford 7840 - 8340 Side Stud 7740 7840 8240 8340 ts90-120 Genesis Pump

Gasket=1402



403539
Water Pump Ford 7840 - 8340 TS - Front Stud

Gasket=1402



41032
Water Pump New Holland Combine 8060 8055



4728
Water Pump Ford 8210 TW10 TW15 TW20 TW30 145mm Pulley



43667
Water Pump New Holland TD4020 TD4030 TD4040 TD5010 TD5020 TD5030
OE Ref: 504216828

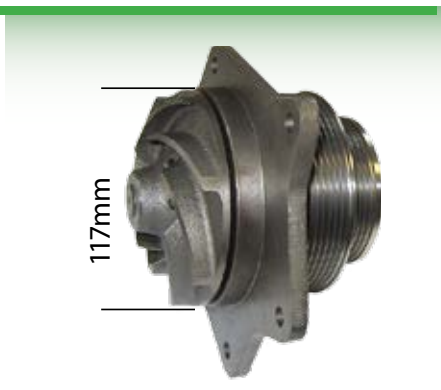

409675
Water Pump Ford TM 115 - TM165 8160 - 8560 UP 06/2002 - 117mm Impeller
**Note has Small Impeller **



41029
Water Pump Case Maxxum MX Cummins Engine New Holland TSA / T Series 148mm Centre Hole 78mm Impeller

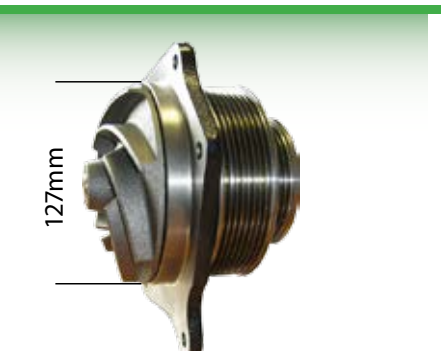

41697
Water Pump Ford TM120 - TM190 New Type 127mm Impeller c/o O Ring - From 06/02



43597
Water Pump New Holland T6000 Series T7000 T7 Series OE Ref: 2854835

Cooling System Pumps



409673
Water Pump Plug Ford TM115 -
TM165



4922
Water Pump Gasket Ford 40's



41871
Thermostat Gasket Ford
TM TW G 70 Series



42251
Gasket Ford 5640 6640 7740 7840 Water
Pump 8240 8340 TS100 TS110 TS80 TS90



409674
Water Pump Cover Gasket
Ford TM 115-165



3486
Hydraulic Pump O Ring
Large



409661
Water Pump Gasket Ford 40
TM TS90 - TS115

41049
Water Pump Back
Housing Ford 40
60 M TM TS ** Kit
43189 **



4923
Water Pump Gasket Ford
40's

Engine Parts

Cooling System

Fan Belt

Part No.	Models	Description	Dimensions
1936	Dexta & Major	Cogged	12.5 X 1125
2275	2000 3000 4000 5000		13 X 1375
3790	200 500 10's 100's		13 X 1400
2240	7600	Double Pulley	13 X 1225
3370	66/76	Alternator Belt Double Pulley	13 X 765
4423	76/7610	Double Pulley Main Belt	
4456	76/7610/7810	Short	13x800
4254	7810 Late	Long	13 X 1150
4794	8210 TW5 10 15 20		13 X 1470

40's/TS

Part No.	Models	Description
402914G	40 TS 110 TS115 6PK2217	w/o Air Con Original
402915G	40 TS110 TS115 6PK2554	c/w Air Con Original
404857	TS 80 90 100	w/o Air Con 6PK2228
404857G	TS 80 90 100	w/o Air Con 6PK2225

TM

Part No.	Models	Description
404859G	8100 8200 8300 8560	8PK1475
41051G	8160 8260 8560 M	8PK1951
43207	Fan Belt Ford TM120 130 140 155 175 190, also	8PK2030

TSA/T6/T7

Part No.	Models	Description
41635G	TSA 100-135 T6000	8PK1551
41636	TSA 100-135 & T6000	c/w Air Con

TL

Part No.	Models	Description
43128	TLA T4 T5	8PK1381



Cooling System

Pulleys



3323
Idle Pulley Assembly Ford 7610
7810 7610 4 Cyl 1981-91, 7810 6 Cyl
1988-91



42092
Pulley Idler Pulley Ford 7610
7810 7610 4cyl
Part Of 3323

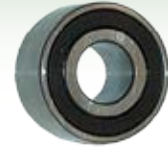

41157
Bearing to suit 42092 & 2953
Pulley



42093
Back Plate Idler Pulley Ford
7610 7810 7610
Part Of 3323



42090
End Cap Idler Pulley Ford 7610
7810 7610 4cyl
Part Of 3323



42089
Ring Clip Idler Pulley Ford
7610 7810 7610
Part Of 3323



4895
Pulley Bearing Assembly Ford
TW



2953
Pulley Ford 7600 Idler Pulley
Assembly 7600 7700 6600 from 1975-
81 3 Cylinder



42091
Snap Ring Idler Pulley Ford
7610 7810 7610
Part Of 3323



4145
Thermostat Housing Ford 2 - 7610 2000
3000 4000 5000 6000 7000 2600 3600 4600
5600 6600 7600



3863
Thermostat Gasket Ford - All
Models

Gasket = 3863

Cooling System

Air Conditioning

43158

Compressor Air Conditioning Ford 40 Series

OE Ref: 82001879



43033

Compressor Ford 4340 5340 5640 6640 7740 7840 8240 8340 TS100 TS110 TS115 TS90 8340 Turbo



42187

Compressor Ford TM Air Conditioning 8160 8260 8560 M100 M115 M135 M160 TM115 TM120 TM125 TM130 TM135 TM140 TM150 TM1

OE Ref: 87709786



43161

Compressor Air Conditioning Ford 35 Series TD Series TL Series Case IH JX Series Fiat 86 Series 94 Series L Series

OE Ref: 5165549



52232

Compressor Case IH 140 Maxxum 100 MXU100 MXU110 MXU115 MXU125 MXU130 MXU135 Maxxum140Ford TS100A TS110A TS115A TS125A TS130A



43002

Compressor Air Conditioning New Holland T6010 T6020 T6030 T6040 T6050 T6060 T6070 T6080 TS100A TS110A TS115A TS125A TS130A TS135A



43502

Compressor Air Con Ford T7030 T7040 T7050 T7060

OE Ref: 87709773



43159

Receiver Dryer Ford 40s 60s TMs TSs Fiat M Series

OE Ref: 82007131



42189

Filter Drier Ford TM Air Conditioning

OE Ref: 82023593



43513

Condenser Ford 5640 6640 7740 8240 8340 up to 1/11/95 - New Holland TS Air Conditioning

OE Ref: 82000921



43514

Condenser Ford TL TLA 35s Air Conditioning

OE Ref: 5166770

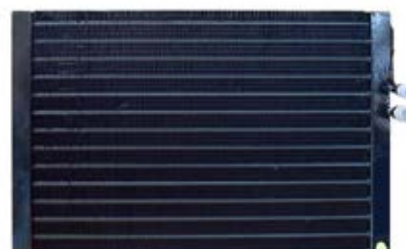

Cooling System

Air Conditioning

43160

Blower Motor Assembly Ford
35 Series TL Series Fiat L Series
OE Ref: [82002761](#)



43162

Blower Motor Ford 10 Series
100 Series 5610 6610 7610
7710 7810 8210 3600 4600
5600 6600 6700 7600 7700 OE
Ref: [86010530](#)

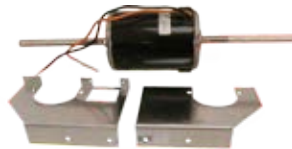

43163

Blower Switch Ford 10s 3600
4600 - 7700 8530 - 8830 5640
- 8340 8160 TL100 TL80 TL90
TMs TS100 TS110 TS115 TS90
TWs Deutz Agrottron OE Ref:
[83907434](#)



43040

Blower Switch Ford 40
Series 60 Series TD Series
TM Series TS Series Fiat M
Series Case



42111

Cab Blower Ford 40 60
TM TS Also fits Case JX
MXM



43039

Thermostatic Switch
Ford 40 Series 60
Series TM Series TS
Series Fiat M 100 115
135 160



42188

Valve Expansion Air
Conditioning Ford TM
Also fits Ford 40 60 TS
OE Ref: [82000932](#)



43035

Valve Expansion Ford
4635 4835 5635 6635
7635 TL TLA TN TSA
Series



43557

Water Heater Valve
Ford 4635 4835 5635
6635 New Holland
TL70 TL80 TL90 TL100
Fiat L60 L65 L75 L85
L95 OE Ref: [82008282](#)



43598

Thermostat New Holland T6 T6000 T7
T7000 Seri Case Puma CVX Puma CVT
Maxxum Series Steyr 4120 Profi 4130
4135 4145 4125 4110 OE Ref: [84322388](#)



43245

Thermostat Air Conditioning Switch
Ford NewHolland T6010 - T6080
T7030 - T7060 TS100A TS110A
TS115A TS125A Case Maxxum 100 -
140 OE Ref: [84240633](#)



53109

Air Vent 169 x 62 x 12mm
Cut Out 146 x 44mm



42190

Air Vent CNH JCB 143 x 52 x 27mm
Cut Out 132 x 49mm



62846

Air Vent 280 x 235mm
Cut Out 261 x 225mm
CX & Massey Ferguson



62847

Air Vent 390 162 x 35 x 20mm
Cut Out 150 x 32mm



53110

Air Vent Round 100mm No Spigots
Outer Diameter 100mm Cut Out
76.5mm



53111

Air Vent Round 100mm c/o 65mm Spigot
Outer Diameter 100mm Cut Out 76.5mm



Date:.....

No. of Pages:.....

Name of the Rep.....

A/C Number:.....

From:.....

e-mail.....

Phone No.:.....

Fax No.:.....

Please quote for the following parts - Quotation Number :

I wish to confirm the following order on Quotation Number:

Please supply the following parts:

	Qty	Part No.	Description	Unit Price
1.				
2.				
3.				
4.				
5.				
6.				
7.				
8.				
9.				
10.				
11.				
12.				
13.				
14.				
15.				
16.				
17.				
18.				
19.				
20.				
21.				
22.				
23.				
24.				

Please photocopy this page

Please do not remove this page

Comments:

Customer Signature:

Rep's Signature:

Tel No: + 353 44 934 1638

e-mail: info@qtponline.com, www.qtponline.com

Page of

Cooling System

Radiator Cowls



41593
Radiator Cowl Ford
3000 3610 2000 3000
4000



41594
Radiator Cowl Ford
5000 6600 16"



41595
Radiator Cowl Ford
6610 1981 - 1991
No Air/Con



41851
Radiator Cowl Ford 6610
7610 17" blade



3905
Fanblade 200 300 3600
500 Plastic 8 Blade



2256
Fanblade Ford 5600 - 7600
7700 6 Blade 6410 - 6610 17"



4358
Fanblade Ford 7610 7 Blade
17" - Early



1320
Fanblade Ford TW15
- 6 Blade



1306
Fanblade Ford
TW20 30 & Old
97s 22"

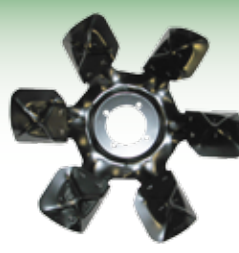

41894
Fanblade Ford 40
TS115 4 Cylinder



42136
Fanblade Ford TM 120 130
140 20 x 16 Mechanical
Transmission



42147
Fanblade Ford
TM



409711
Water Pump
Spacer Ford
7600 - 1922
Water Pump To
replace Viscous



404891
Water Pump
Spacer Ford
5610 6610 **
1922 is Pump

Cooling System Parts

Viscous Fans



2608
Viscous Fan Unit
Ford 7610



41117
Viscous Fan
Ford 7840



41118
Viscous Fan Ford
8340 - Clutch Type



Front



Back

42167
Viscous Fan Ford TM140



43188
Viscous Fan Ford
TM150 TM165 8560
CCLS TV140 Fiat M160 CCLS



43187
Viscous Fan Ford 8160 8260
8360 8560 TM115 TM125 TM135
Fiat M100 M115 M135 M160

Radiators



41501
Radiator Fordson Dexta
Standard



41559
Radiator Fordson
Super Dexta



4825
Radiator Ford 2000 3000
4000 - 4 Row



4826
Radiator Ford 5000 6600 - 4
Row



43017
Radiator Fixing Bolt Ford 3600 4600 5610 6610 7610 7710

Cooling System Parts

Radiators



41427
Radiator Major Standard & Power Core 435mm wide x 470mm high



41560
Radiator Super Fordson Major



4276R
Radiator Ford c/o Oil Cooler 6610 7600 7610



41627
Radiator Ford c/o Oil Cooler 7810 & Late 7610 7610 from 01/06/89 c/w A/C & Viscous Fan



43011
Radiator Ford 8160 8260 8360 8560 TMs from 11/99 to 06/02 - TM115 TM125 TM135



41887
Radiator Ford 5640 6640 7740 - 4 Cylinder **Also early TS90 TS100**



41928
Radiator Ford 7840 - 8340 (6 Cylinder) **Also early type TS110 TS115**



41931
Radiator Ford TM140 TM155 Case MXM140 MXM 155 From Serial ACM256706 Cap = 42029



43013
Radiator TM150 TM165 Full Powershift Transmission 18x6 40KPH 4WD & 17x6 30KPH 2WD



41886
Radiator Ford TM175 TM190 Case MXM190



43001
Radiator Ford New Holland 5635 6635 7635 TK Series Crawlers TK100A TL Series TL100 TL80 TL90 TK90 Fiat L75 85 95 Case JX100 JX80U



43131
Radiator Ford T6010 T6020 T6030 TS100A TS135A
OE Ref: 87306757

TM Radiators

43487
Radiator Ford TM120 TM130 Case MXM120 MXM130 - Oil Cooler Pipes Face Engine [OE Ref: 87352188](#)



Cooling System Parts

Thermostats



4398
Thermostat Ford 82| c/o Pin Case CX70
80 90 3000 Series John Deere 40 Ford
40 60 M TM TS



4058
Thermostat Ford 78|



3868
74°
Thermostat

48837
Thermostat
Fordson 2N
8N 9N 180|



41216
Thermostat
Housing Fordson
Super Major



Gasket = 3863

Radiator Caps

4023
Radiator Cap
Ford 7lb



2083
Radiator Cap Massey
Ferguson & Ford 10
Lb



4717
Radiator Cap
Ford 13 Lb

41805
Radiator Cap Fordson



48808
Radiator Cap Fordson N's
2N/8N/9N (1943-1952)



41228
Radiator Cap Fordson Super
Major



41877
Radiator Cap Ford TM120 -
TM190 22lbs



42029
Radiator Cap TM MXM **To Suit
Clancy Rads 41931 & 41886**



40's Cooling System

Fanbelt Less Air Conditioning

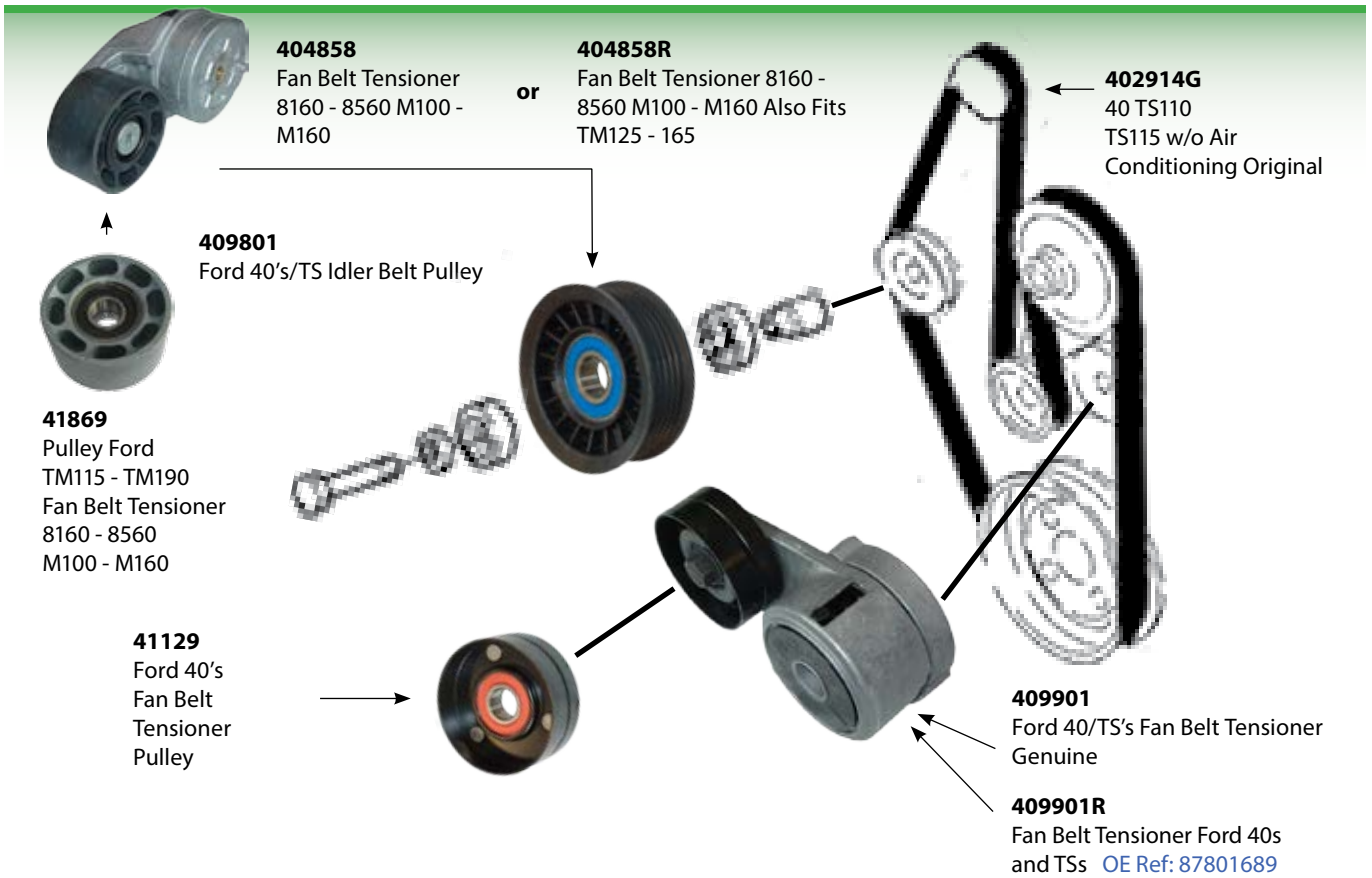

Fanbelt With Air Conditioning

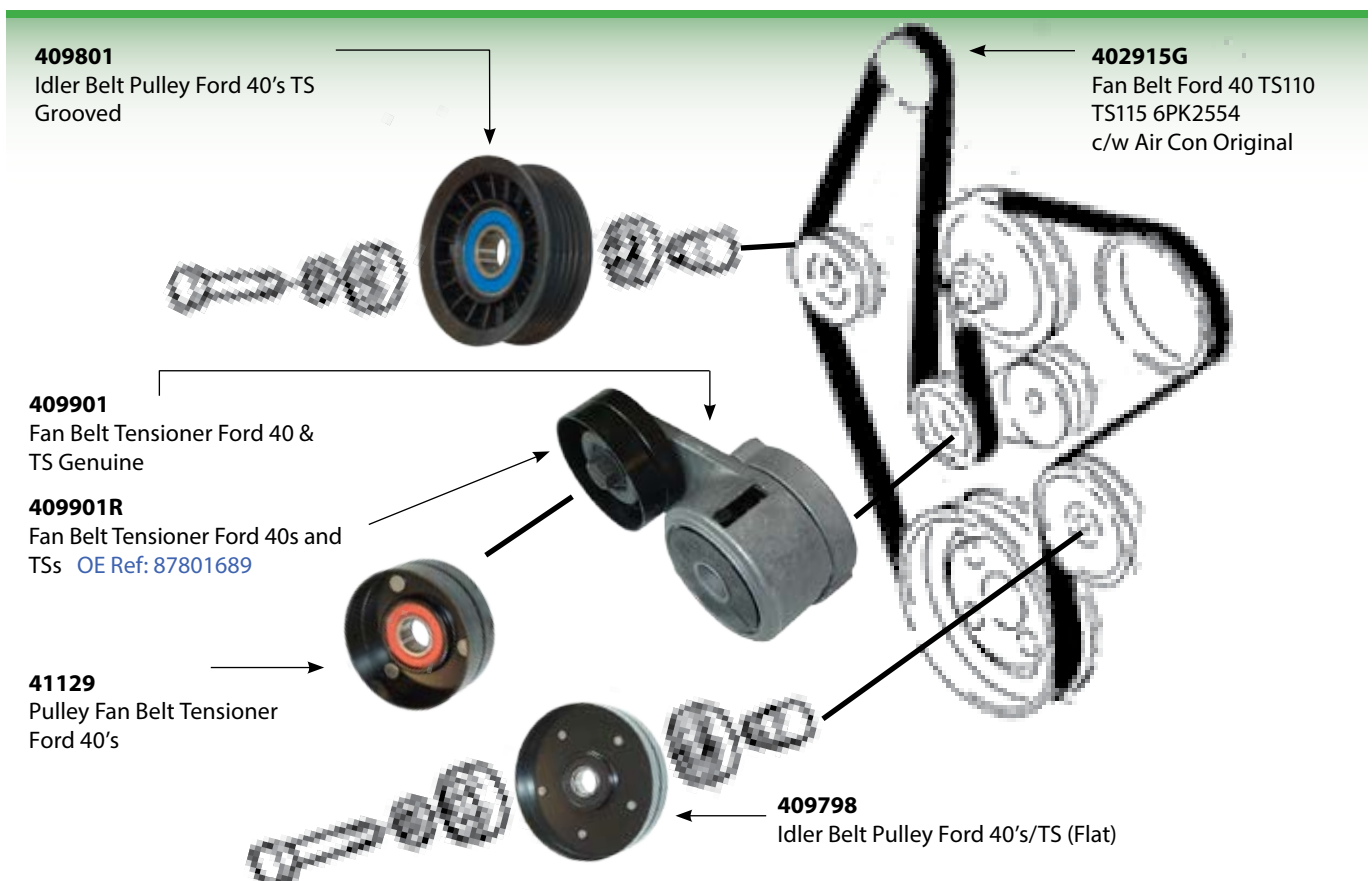

Hoses

Dexta



Hose Clips=2440

4053
Hose Radiator Ford Dexta Top (935)



Hose Clips=2440

1861746
Air Cleaning Hose 135 Dry 1438 Dexta Super Dexta



Hose Clips=2440

4054
Hose Ford Dexta Bottom (487)
Dexta F3.144 and Super Dexta F3.152



Hose Clips=2440

41046
Hose Water Filler Dexta

Major Hoses



4055
Hose Radiator Major Power Super Top (310) 445

Hose Clips=2440



Hose Clips=2426SS

4056
Hose Major Bottom (311)
Major - Super - Power



41784
Water Filler Neck Bracket
Major / Dexta Neck to suit
41049 Hose



41069
Hose Major Super Major Radiator Filler ID 45MM OD 55MM Centre to Centre 220

Hose Clips=2413SS



41068
Hose Air Breather / Filter Major

Hose Clips=2440

2/3/5/66/7610 Hoses



4051
Hose Radiator Ford 2000 3000 5000 66 7600 Top

Hose Clips=2413SS



4052
Hose Radiator Ford 5000 6600 Bottom (608)

Hose Clips=2440



4339
Hose Kit Ford 5000

Hoses

4/4600 Hoses



4050
Hose Radiator Ford 2000 4000
Bottom

Hose Clips=2440

4338
Hose Kit Ford 4000



10 Series Hoses



1731
Hose Radiator Ford 7810 Top

Hose Clips=2413SS



1742
Hose Radiator Ford 6810 7810
Bottom

Hose Clips=2426SS



41121
Hose Kit Ford 7610

4052
Hose Radiator Ford 5000
6600 Bottom (608)



Hose Clips=2440

4051
Hose Radiator Ford 2000
3000 5000 66 7600 Top

Hose Clips=2413SS



40's 4 Cylinder 40's 4 & 6 Cylinder

40's 6 Cylinder



41009
Hose Radiator Ford 40
TS Top 4 Cylinder

Hose Clips=2426SS



404988
Hose Radiator Ford 5640 8340
Bottom
Also TS80 TS110 Hose Clip
2440

Hose Clips=2440



42166
Hose Main to Aux Tank
Joiner Ford 40 Series



404989
Hose Radiator Ford
40 Top 6 Cylinder



41876
Hose Ford TM120 -
TM155 Top Radiator

Hose Clips=2413SS



43060
Hose Radiator Ford TM120 TM130 TM140
TM155 TM140 TM155 TM175 TM190 Case
MXM120

41876= Top one to suit



41845
Hose Top Ford 8530-8830 TW10-
TW35

Hose Clips=2413SS

General Water Hoses

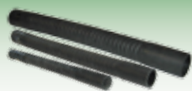

2603
1 1/4' X 17' Flexible Hose

2615
2' X 23' Flexible Hose

2609
1 1/2' X 19' Flexible Hose



Straight Hoses

4530	1" X 3
4531	1 1/8" X 3
4532	1 1/4" X 3
4533	1 3/8" X 3
4534	1 1/2" X 3
4535	1 3/4" X 3
4536	2 3/4" X 3

90° Bend Hoses

2596	1" (8" X 16")
2597	1 1/4" 90° (8" X 16")
2598	1 1/2" 90° (8" X 16")
2599	1 3/4" 90° (8" X 16")
2600	2" 90° (8" X 16")
2601	2 1/4" 90° (8" X 16")
2602	2 1/2" 90° (8" X 16")

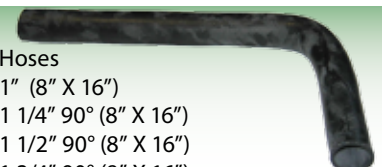

Hoses Clips

Original Type



Part No	Diameter (""")	Diameter (mm)
50999	5/16" - 15/32"	8-12
50998	3/8" - 5/8"	10-16
50997	15/32" - 3/4"	12-20
50996	5/8" - 1"	16-25
50995	23/32" - 1"	18-26mm
50992	7/8" - 1 3/16"	23-36
50991	1 27/64" - 1 39/64"	36-41mm
50990	1 21/32" - 1 27/32"	42-47mm
50989	1 49/64" - 1 31/32"	45-50mm
50988	1 5/16" - 2 3/8"	40-60mm
50986	2 3/8" - 3 3/16"	60-80
50985	2 3/4" - 3 1/2"	70-90

Standard Type



Part No	Diameter (mm)	TYPE
2340SS	9.5-12	Stainless Steel
2345SS	11-15	Stainless Steel
2346SS	12-20	Stainless Steel
2357	16-25	
2357SS	16-22	Stainless Steel
2364SS	18 - 25	Stainless Steel
2394	23-35	
2394SS	25- 35	Stainless Steel
2396	28-48	
2397SS	30 40	Stainless Steel
2413SS	35-50	Stainless Steel
2426SS	45-60	Stainless Steel
2440	50-70	
2440SS	55-70	Stainless Steel
2441SS	60-80	Stainless Steel
2443	70-90	
2443SS	70-90	Stainless Steel

Small Hose Clips

Part No	Diameter (mm)
59659	11
59660	13
59658	14
59661	17



Heavy Duty Clamp

Part No	Diameter (mm)
51934	122 - 130
51933	113 - 121



Air Filters

KEY

L: Length

OD: Outer Diameter

ID: Internal Diameter

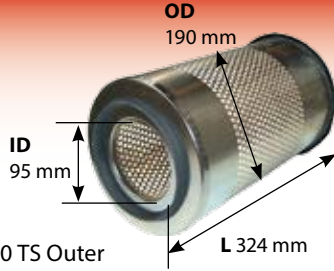
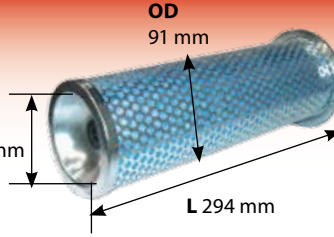
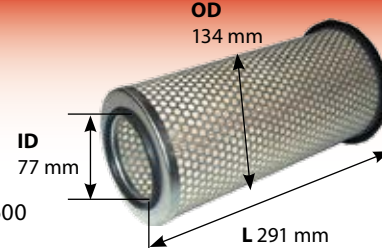
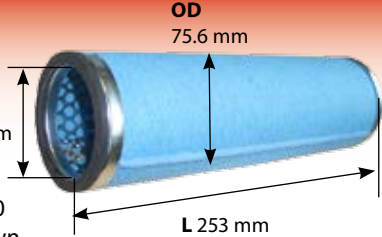
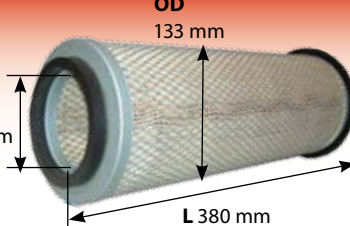
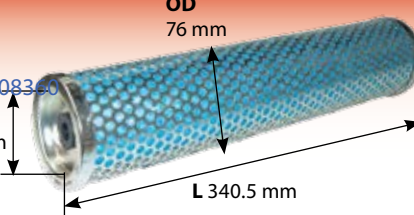
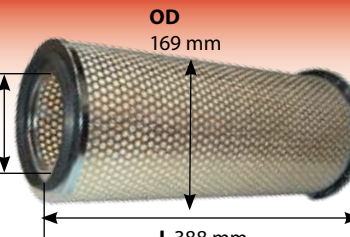
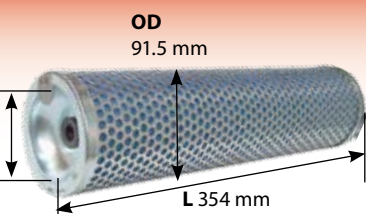
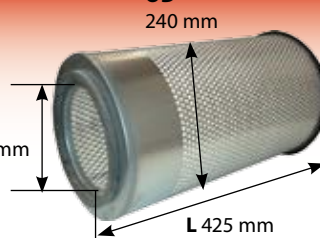
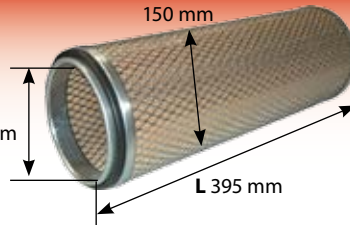
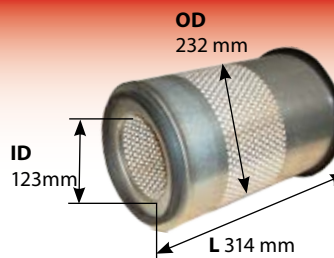
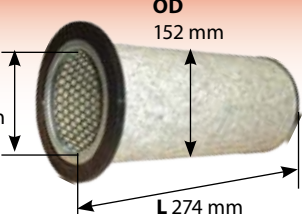
<p>402816 Air Filter Ford 40 TS Outer TM115</p>  <p>OD 190 mm ID 95 mm L 324 mm</p>	<p>409852</p>	<p>402817 Air Filter Ford 40 TS Inner TM115</p>  <p>OD 91 mm ID 76.2 mm L 294 mm</p>
<p>1416 Air Filter Ford 4600 Outer</p>  <p>OD 134 mm ID 77 mm L 291 mm</p>	<p>41098</p>	<p>1417 Air Filter Ford 4600 Inner & David Brown 1390</p>  <p>OD 75.6 mm ID 62 mm L 253 mm</p>
<p>409840</p>  <p>OD 133 mm ID 81 mm L 380 mm</p>	<p>409840 Air Filter Kit Ford 5600 6600OE Ref: 83908360 & 83908365</p>	 <p>OD 76 mm ID 62 mm L 340.5 mm</p>
<p>1411A Air Filter Ford 7600 8600 Outer</p>  <p>OD 169 mm ID 96 mm L 388 mm</p>	<p>41086</p>	<p>1487 Air Filter Ford 7600 8600 Inner</p>  <p>OD 91.5 mm ID 72 mm L 354 mm</p>
<p>2405 Air Filter Ford TW 15 Outer</p>  <p>OD 240 mm ID 143 mm L 425 mm</p>	<p>41116</p>	<p>2339 ** USE 41116 Kit **</p>  <p>OD 150 mm ID 115 mm L 395 mm</p>
<p>403962 Air Filter Ford 8340 Turbo Outer</p>  <p>OD 232 mm ID 123 mm L 314 mm</p>	<p>41590</p>	<p>403976 Air Filter Ford 8340 Turbo Inner</p>  <p>OD 152 mm ID 100 mm L 274 mm</p>

Air Filters

KEY

L: Length

OD: Outer Diameter

ID: Internal Diameter

402818

** USE KIT 41099 **

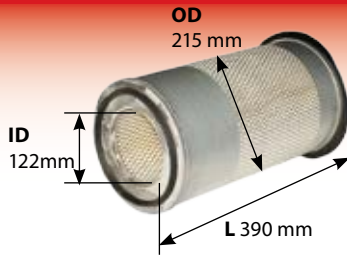

41099

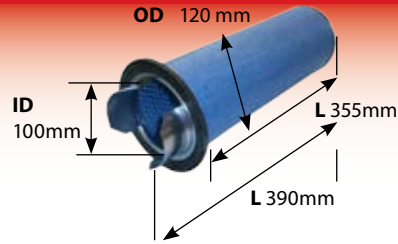

402819

Air Filter Ford 60
TM Inner

780105

Air Filter Ford TS100A
TS110A Outer T6020
T6040 T6060 Elite ** Kit
41518 ** TS100A Delta &
Plis Renault 600

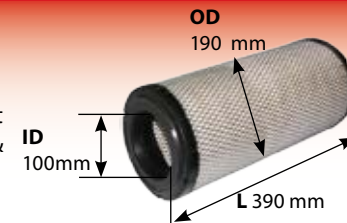

41518

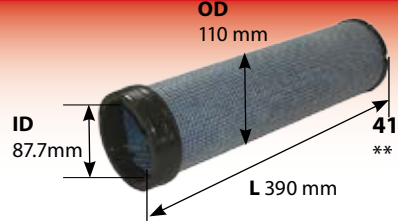

41256

** Kit is 41518 **

41252

Air Filter Ford TS115A
- TS135A Outer

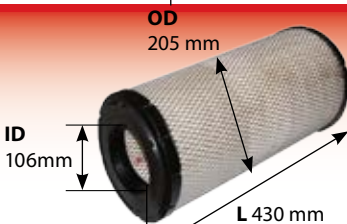

41517

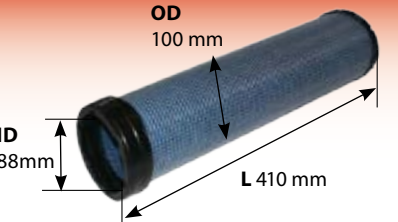

41253

Air Filter Ford
TS115A - 135A
Inner

42238

Air Filter Ford T7030 T7040 T7050
T7060 Outer

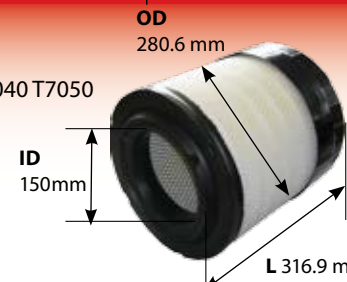

42884

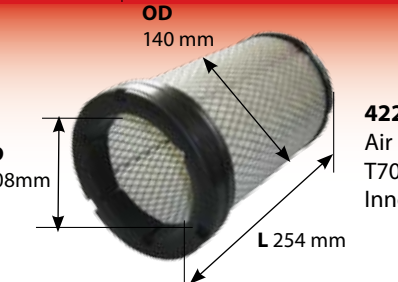

42237

Air Filter Ford T7030
T7040 T7050 T7060
Inner

7123

Air Filter Fiat 82 94 88 94 Outer Ford L
Series ** Inner is 7125 **

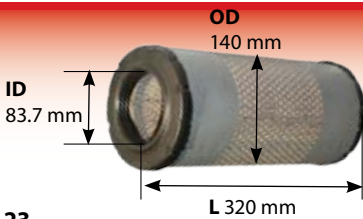

42242

Air Filter Ford TS115A TS1250A
TS135A Outer

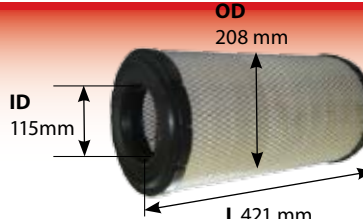

42241

Air Filter Ford TS100A TS110A
Outer with Pre Cleaner

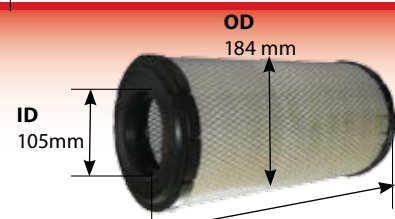

41122

Air Filter Ford TW25 30 35 Outer **
Inner 41123 ** Kit 43140 **

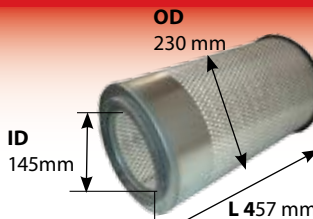

43140

41123

Air Filter Ford TW25 30 35 Inner **
Outer 41122 ** Kit 43140 **

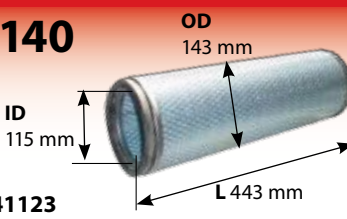

7125

Air Filter Fiat 82 94 88 94 Inner
Ford L Series ** Outer is 7123 **

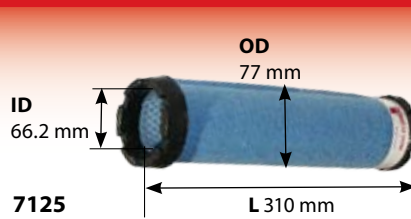

41646

Air Filter Ford
TM175 TM190
Inner

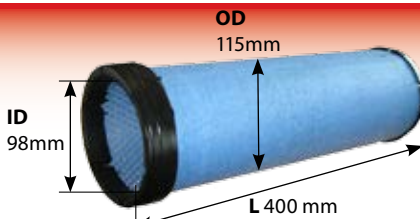

41647

Air Filter Ford TM175
TM190 Outer

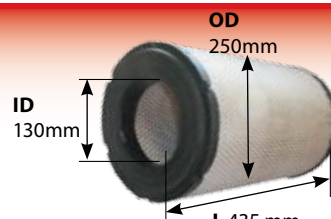

Air Filters

KEY

L: Length

OD: Outer Diameter

ID: Internal Diameter

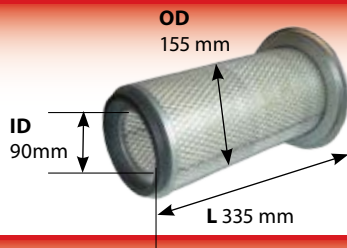

41045
Air Filter Ford 6635 TL70
80 90 100 F Outer

42135

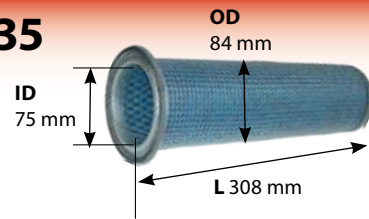

41044
Air Filter Ford 6635 TL70 80
90 100 F Inner

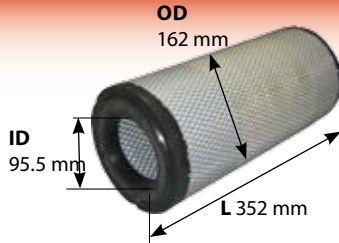

7330
Air Filter Kit Fiat 80-90 & 110-90
OE Ref: 1930590 & 1930589

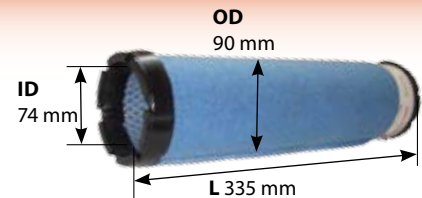

4675
Air Filter
JCB 3CX
Inner

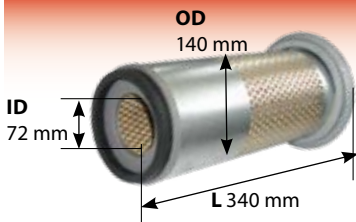

51733
Air Filter Case
JX85-65 NH
L60-75

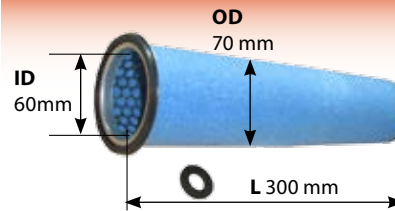

42236
Air Filter Ford T5030 T5040
T5050 T5060 Outer T5070

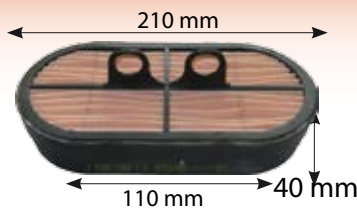

42235
Air Filter Ford
T5030 T5040
T5050 T5060
Inner T5070

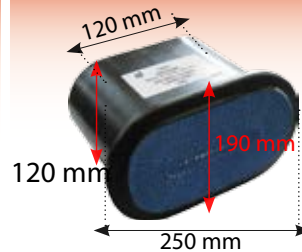

43499
Air Filter Ford T5105 T5115
T595 Outer T4105 T4115
T475 Powerstar
OE Ref: 84479228



43500
Air Filter Ford T5105 Inner
Outer Filter is 43499
OE Ref: 84479225



52356
Air Filter Outer
New Holland T8000 Series - T8010, T8020, T8030,
T8040, T9000 Series - T9010, T9020
TG245, TG275, TG305, TJ275, TJ280, TJ325, TJ330
STX275 STX325 Ford T8000 Series T9000 Series
OE Ref: 367349A1

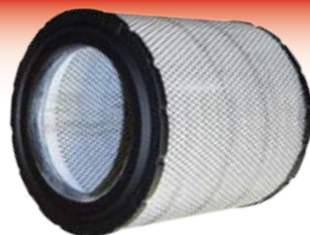

52357
Air Filter Inner
New Holland T8000 Series - T8010, T8020, T8030, T8040, T9000
Series - T9010, T9020
TG245, TG275, TG305, TJ275, TJ280, TJ325, TJ330
OE Ref: 367350A1

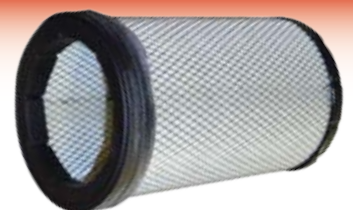

Cab Air Filters

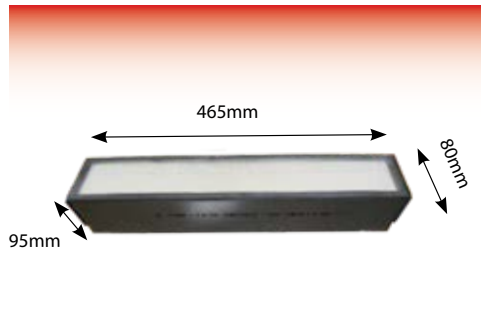

43145

Air Filter Cab Super Q Ford 5610 6410 6610 7610 7710 7810 8210 8530 8630 8730 8830 TW5 TW10 TW15 TW25 TW35
OE Ref: [E4NN94000N20AF](#)

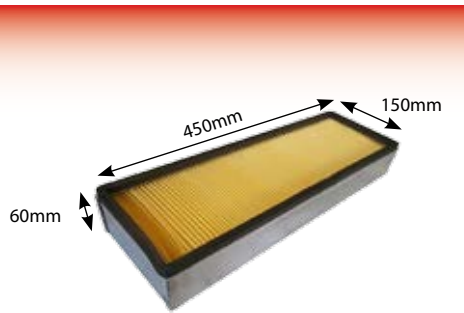

43150

Cab Air Filter Q Cab Ford 2600 3600 4600 4610 5600 5610 6410 6600 6610 6810 7600 7610 7710 8210 TW10 TW20 TW30
OE Ref: [83916852](#)



43694

Cab Air Filter Ford 6410 6610 6810 7610 8210 TW Series
OE Ref: [83913701](#)

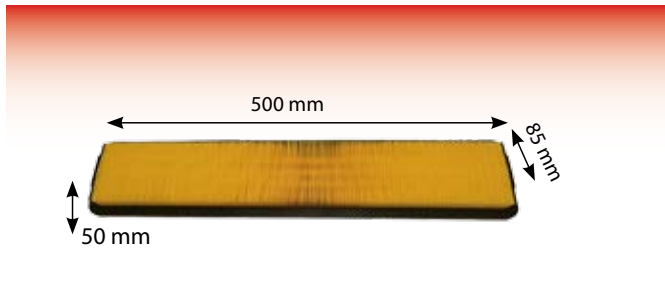

42177

Cab Air Filter New Holland 5640 6640 7635 7740 7840 8160 8260 8360 8560 T5030 T5040

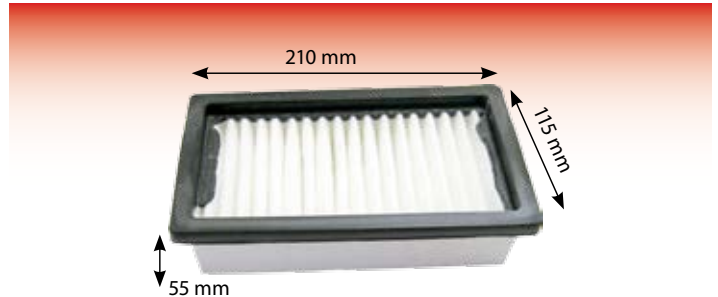

42180

Cab Air Filter New Holland TM120 130 140 155 175 190

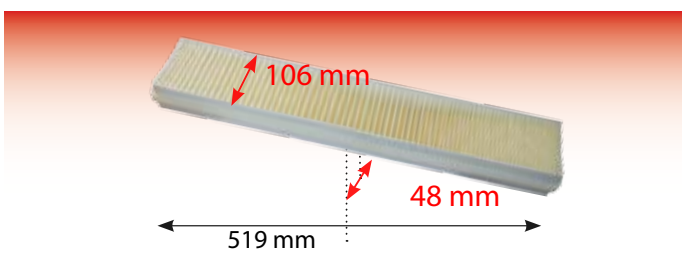

42273

Cab Air Filter TS110 TS115 TS90

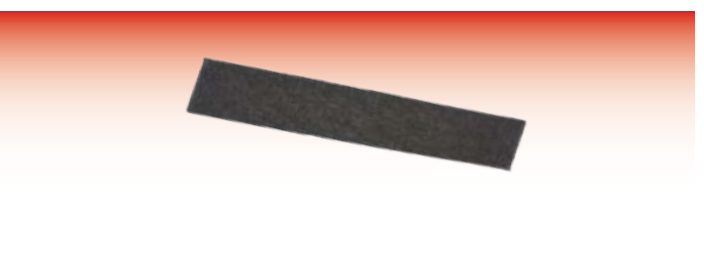

43506

Pre Filter Cab Air Filter New Holland TLA Case JXU MXM
OE Ref: [83994694](#)



43339

Cab Air Filter Ford TN60 TN70 TN75 TN85 TN95 Case JX1060C JX1070C JX1075C JX1085C JX1095C
OE Ref: [47129134](#)



52261

Cab Air Filter New Holland TS100A - TS135A T7030 - T7060 T6010 - T6080 Case CVX MXU Puma
OE Ref: [87302687](#)

Cab Air Filters

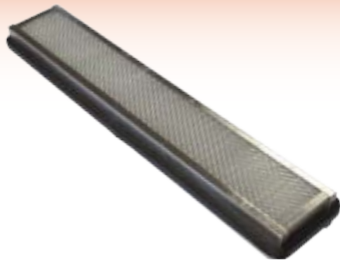

52462
Cab Air Filter TS110 TS115 TS90
Case MXM120 MXM130 MXM140 MXM155 MXM175
MXM190 OE Ref: [82034661](#)

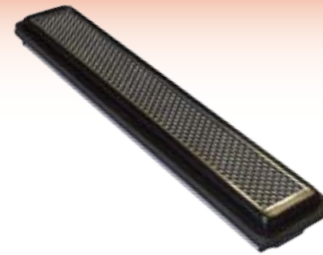

52468
Cab Air Filter Carbon Pesticide TL100, TL70, TL80, TL90,
TL100A, TL70A, TL80A, TL90A, TM115, TM120, TM125, TM130,
TM135, TM140, TM150, TM155, TM165, TM175, TM190, TS100
TS110 TS115 TS90 OE Ref: [5097838](#)



52467
Cab Air Filter New Holland TN55V TN60VA TN65V TN70VA
TN75V TN95VA Case JX1060C JX1070N JX1075N JX1075V
OE Ref: [44910397](#)



CHARCOAL FILTER - CHEMICAL APPLICATION

43682
Cab Air Filter New Holland TN Case JX OE Ref: [44911740](#)



42178
Cab Air Filter New Holland T6010 6020 6030
6040 6050 6060 6070 6080 7030 7040 7050 7060
TS100A 110A 115A 125A 135A TSA100 125 135



CHARCOAL FILTER - CHEMICAL APPLICATION

43681
Cab Air Filter New Holland T6 T7 TSA OE Ref: [87309516](#)



43669
Cab Air Filter New Holland T4 T5 Series Case
Farmall Series Steyr Kompakt Series
OE Ref: [84577445](#)



43680
Cab Air Filter New Holland T6 TSA Case
Maxxum MXU Steyr Profi OE Ref: [87726696](#)

Air Filter Assemblies & Mounting Bands

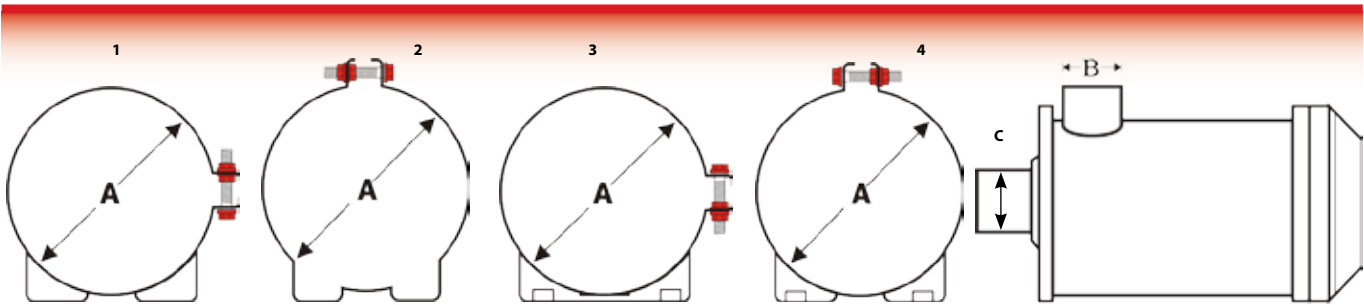

Out. Filter To Suit	Air Filter Assemblies			Mounting Bands		
	Part Number	B(mm)	C(mm)	Part No	A (mm)	Figure
CH0511555		51		CF0511956	133	3
				CF0511957		4
CH0511467				CF0511957	133	4
1659	FC061160400	63.5	57	CF0611043	165	2
						CF0611043
3280	FC081100200	76	76	CF0812908	203	1
				FL081130600		95.5
CH1011308				CF1011131	260	1
CH1211389		127				

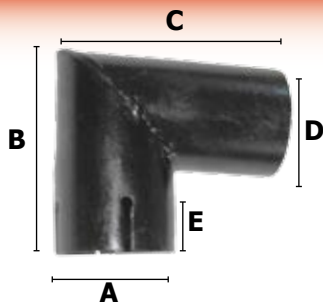

Sizes In Millimeters

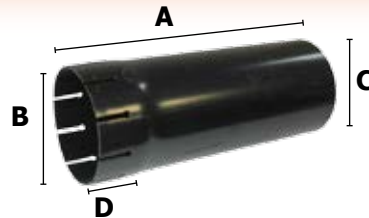

P. No.	A	B	C	D	E
12194	44.2	81	90	45	36
12193	51.1	100.5	100	51	40
12192	63.6	92	152	63.5	28

P. No.	A	B	C	D
12190	110	64	63.5	30
12191	110	76.5	76	32
11099	200	76.5	76	32
12805	530	102.5	102	70

Pre Cleaners

61224
Glass Bowl 6"

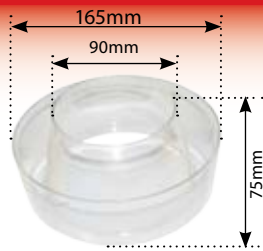

2350
7000/7600
Pre Cleaner Glass

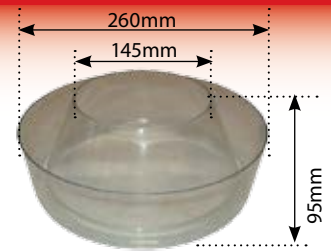

4297
Pre Cleaner Assembly Ford 7600
- 76mm
** Economy version is 4297E **



4297E
Pre Cleaner Assembly Ford
7600 - 76mm
** Economy **



1410 Centrifugal
Pre-cleaner 3 3/4"



41325
Oil Bath Assembly Ford
2000 3000



41827
Air Filter Assembly
Cover Ford 2000 3600 **
Petrol Type **



41854
Oil Bath Assembly Ford
6600



41890
Engine Breather Standard
Major Blue With Mesh Filter
Hole ID 16.7mm



41889
Engine Breather Super Major
Grey Hole ID 12.30mm



409681
Air Filter Assembly
Ford 8360 8560 TM
110 165



41326
Oil Bath
Assembly Ford
5000



43132
Oil Bath Fordson
Major ** Suits
Power and Super
Major **



43197
Oil Bath Fordson
Major Standard



43198
Oil Bath Bowl Fordson Major
Standard Super Power ** Suits
43132 + 43197 **



43199
Oil Bath Element Fordson Major
Standard Super, Power ** Suits
43132 + 43197 **



41969
Pre Cleaner Pipe Ford 7000
- Hi Version **Suits High
Pre Cleaner**
Also 7700 7710 TW10



409796
Ford 40'S
Air Breather
Pipe



4160
6610 Air Breather Hose



43074
Hose Intercooler To Air
Intake Manifold Ford TM

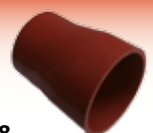

43098
Hose Intercooler to
Turbo Ford TM120

Individual Filters

Air Filters



41569
Pre Cleaner
Dexta Blue
Diesel -
50mm Air Hat



3029
Air Filter Hat
Ford 4000
Major - 58mm
Pre Cleaner



3022
Air Filter Hat Ford
2000 3000 - 54 x
7" Pipe **54mm
diameter** Pre
Cleaner

3022S
Air Filter Hat Ford 2000
3000 - 54mm x 4" Pip



3045
Air Filter Hat Ford
6600 - 64mm
Also fits 4100
4600 5600 5900
6600 6700 David
Brown 990 995
996



41856
Air Hat Ford
5000 Black -
55mm
Pre Cleaner

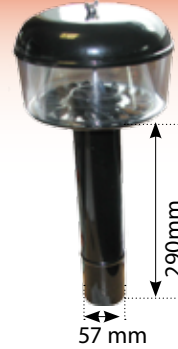

48852
Pre Cleaner Ford
6100 - 57mm
Air Hat



Ref	Type	A(mm)	B(mm)
CP11080	STEEL	51.20	111.00
CP11105	PLASTIC	51.20	133.00
CP11453	PLASTIC	52.20	152.00
CP12735	PLASTIC	60.20	60.20
CP11081	STEEL	63.70	133.00
CP11934	PLASTIC	65.70	152.00
CP11937	PLASTIC	70.20	70.20
CP11082	STEEL	76.20	172.00
CP11031	PLASTIC	76.20	186.00
CP12184	STEEL	85.20	152.00
CP11173	PLASTIC	96.20	250.0
CP15096	PLASTIC	101.20	250.00
CP12733	STEEL	106.00	250.00
CP15092	STEEL	115.20	250.00
CP11181	STEEL	153.20	405.00
CP11183	STEEL	154.20	405.00
CP11274	STEEL	179.20	250.00

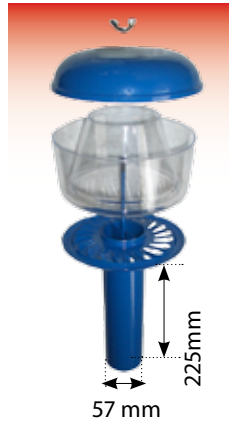

3798
Pre Cleaner Ford
5000 - Plastic -
57mm Air Hat



48850
Pre Cleaner
Ford 6600
Short - 65mm

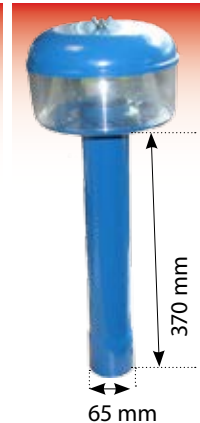

48851
Pre Cleaner Ford
6600 Long - 65mm

P. No.	A	B
CT11050	96	270
CT11185	102.2	270
CT12972	110	270
CT11454	114.2	270
CT11455	127.2	270



Engine Oil Filters



1664
Engine Oil Filter Ford Paper



Converts 1664 to 2723G
42771
Spin On Filter Adaptor Set Ford
2000 5000



2723G
Engine Oil Filter Ford 4600 6600 5030
Short (Same as 3115 & 1675) suits 3 + 4
cyl non tur
Single = 2723S **Pack of 12**



4230G
Engine Oil Filter
Ford 7610 5030 4
Cylinder T
Also 2723G (Short)
Pack of 10

Single = 4230S

404130
Engine Oil Filter
Ford 7740 7840
TM M
Pack of 6

Single = 404130S



41257
Engine Oil Filter Ford
TLA TL TS100A - TS135A
T7000 - KITS 41287 &
41286 Filter Engine Oil
McCormick MTX120 135
150



3751G
**** USE 3751R WHEN
STOCK IS GONE **** Engine
Oil Filter Ford TW Genuine
****8530 - 8830**7810 -
8210****



3751R
Engine Oil Filter Ford
TW 7810 8210 8530 8630
8730



1748
Engine Oil Filter Ford
TW30 TW35 TR96



1748G
Engine Oil Filter Ford
TW30 TW35 TR96
Genuine



3890
Oil Filter Ford D & Cargo



1344
Oil Filter Ford County
1004 1124 115mm long
96mm wide

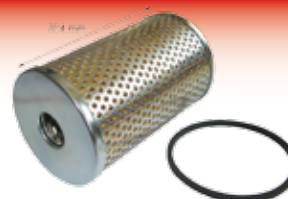

26540132
Engine Oil Filter 35 135 Paper
Fordson Major Dexta

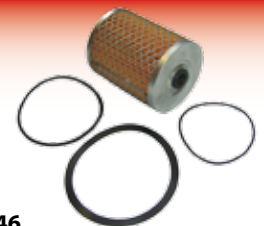

48846
Oil Filter Fordson 2N 8N 9N



52363
Oil Filter Spin On Case Steiger
480 530 535 STX375 STX380
STX425 STX440 STX450
STX485STX485 STX500 STX530
Ford T9050 T9060 John
OE Ref: 324617A1



43498
Oil Filter Ford T5.105
T4000 Series
OE Ref: 87679598



53691
Oil Filter JCB 414S 414S
Agri 416S 416S Agri
New Holland LM5040
LM5080
Oe Ref: 87803261



Filters

Hydraulic Filters

Dexta / Major

Outer Diameter 50mm
Length 87mm



42057
Hydraulic Pressure Return Filter Dexta

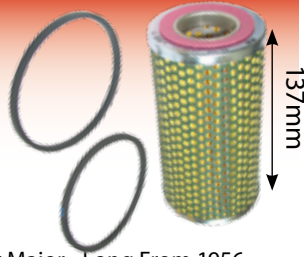

41067
Hydraulic Filter Major - Long From 1956 to 12/1958



41812
Hydraulic Filter Fordson Major 5000 7000 **Long Version is 41067**

600's / 10's

1662G
Hydraulic Filter Ford Back End - Genuine *** Engine Mounted Filter is 1064G ***



Single = 1662S

1064G
Hydraulic Filter Ford 7610 Engine Mounted



35's / TL

41000
Hydraulic Filter Ford 6635 TL70 - 100 Case JX90U and JX



TW's

4129
Hydraulic Filter Ford 8630 TW Same as 1663



4006
Transmission Filter Ford 8630



4327
Hydraulic Filter Ford TW10-35 8630 Genuine



1663
Hydraulic Filter Ford 7000 TW10 TW35



40's SL Dual Power

404912
Hydraulic Filter Ford 40 Dual Power SL Only



402822
Hydraulic Filter Ford 40 SL SLE ** 402822R is Replacement ** OE Ref: 47465237



402822R
Hydraulic Filter Ford 40 SL SLE



40's SLE

402820
Hydraulic Filter Ford 40 TM SL SLE T6 TSA Also needed 404912 SL or 404893 SLE



404893
Hydraulic Filter Ford 7840 SLE Only T6000 & TSA Series Length 235mm ** Same as 59990 & 59990R **



402822R
Hydraulic Filter Ford 40 SL SLE



Hydraulic Filters TM's

402820

Hydraulic Filter Ford 40 TM
SL SLE T6 TSA Also needed
404912 SL or 404893 SLE



404893

Hydraulic Filter Ford 7840
SLE Only T6000 & TSA
Series Length 235mm **
Same as 59990 & 59990R
**



7143

Hydraulic Filter
Ford 60's M TM
Fiat F's



TSA / T6 / T7

Overall height =293 mm
OD=94 mm

41258

TM/TS100A-
TS135A
Hydraulic Filter



42277

O Ring To Suit 41258

42278

O Ring To Suit 41258

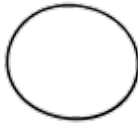

41260

Hydraulic Filter Ford TM
TS100A - TS135A T6000
Series Primary



42122

Hydraulic Filter Ford T6 T7
Secondary *** From September
2009 ***

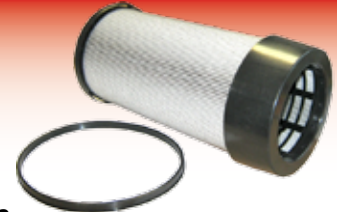

T5 / TLA

Overall height =114.2 mm
OD=53mm



42239R

Hydraulic Filter Secondary Ford T5000 TLA TN Landini Ghibli
Legend Vision - 50mm ID 122mm Case JX JXU McCormick CX
60L 70L 85L

52699

Hydraulic Filter Case IH
JX1090U New Holland TLA



T7510 - T7540

52339

Element Hydraulic Filter
Case CVX New Holland
T7510 T7520 T7530 T7540
OE Ref: 192310280011



52340

Element Hydraulic Filter
Case CVX New Holland
T7510 T7520 T7530 T7540
OE Ref: 192200280705



555 Digger

4815

Hydraulic Filter Ford
Digger 555



41141

Hydraulic Filter Ford 555 655 NH
LB LM Agri



Coolant + Steering Filters

4905

Water Coolant Filter
Ford/Case Maxxum
885xl



4905G

Water Coolant Filter Ford/
Case 885/Maxxum Same
as 4905GENIUNE

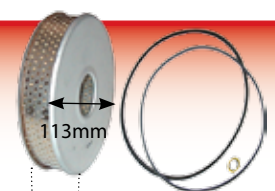

1669

Power Steering Pump Filter Ford
Massey Ferguson 699 David Brown

Fuel Filters



1782
Fuel Filter Massey Ferguson Ford Short 522 Case IH McCormick David Brown Fendt Landini Leyland Renault Same - 100 Box - 20 Tray



1782B
Fuel Filter Massey Ferguson Ford Short 522 Case IH McCormick David Brown Fendt Landini Leyland Renault Same



26561117G
Fuel Filter Agco Genuine Landini Ghibli Case CX50/60 OE Ref: 218577A1 3405418M1



41846
Fuel Filter Dexta Major Length 84.5

26566602G

Fuel Filter Ford TW 200 500 Perkins



26566602
Fuel Filter Ford TW 200 500 (36)



3416
Fuel Separator 3000's/ Ford



61235
Fuel Filter Assembly 100 200 c/o Long Filter Also Fits 4200 4300 6200

41751

Fuel Filter In Line Short Gauze Type



41750

Fuel Filter Large In Line Gauze Type



3082



Fuel Filter IHC Fiat Ford 40 T DX4 Fendt Farmer 300 Favorit 500 600 800 900

3082G



Fuel Filter IHC Fiat Ford 40 T's DX4 ** Perkins **

3082B

Fuel Filter IHC Fiat Ford 40 T DX4 Old Style Serigraphy



409709

Ford TS/TM/M Filter Assy c/w Pump



4917
Fuel Filter Ford 8360 Massey Ferguson 6400 6" High 5 Micron - Secondary(up to 2004 mode



4917S
Fuel Filter Ford 8360 Secondary 64s Normal Flow 6" High 5 Micron Round ** NOT for Electric Fuel Lift Pump System **



4918
Fuel Filter Ford 8360 Primary 4.3" High 150 Micron



4918S
Fuel Filter Ford 8360 Primary 4.3" High 150 Micron ** Normal Flow **

Service Notice

Not Suitable For Electric Type Fuel Lift Pump System
NB Please Check Before Ordering

Fuel Filters



401112
Fuel Filter Ford 8360 -
ELECTYPE 4.3" High 30 Micron
(Stanadyne 401112S)

Service Notice
Suitable For Electric Type Fuel Lift
Pump System
NB Please Check Before Ordering



41844
Fuel Filter Ford TLA TNA &
Water Separator T600 New
Holland ONE FILTER MODEL

43594
- Water in Fuel Sensor M14



43340
Fuel Separator Fuel
Filter Ford TL100A
TL70A TL80A TL90A
OE Ref: 2854796



53685
Fuel Filter Change Indicator
Mounted Prior To Supply
Pump

409665
Water Separator
Ford TM120-
190 (30 Mic)
Fuel Filter
John Deere
4 cyl 6030's
Secondary



409665L
Water Separator
Ford TM120-190
(30 Mic) Fuel Filter
John Deere 4 cyl
6030's Secondary



401111
Fuel Filter Ford
TS TM Valmet
Valtra 6" High 5
Micron - Same
as 401111S



401111S
Fuel Filter Ford
TS TM Valmet
Valtra6" High 5
Micron



41094
Fuel Filter Ford TM120
130 140 155 175 190



409666
Fuel Filter Ford TM120-
TM190 5 Micron Also fits
JCB Engine and JX1090U
from 2008



41611
Fuel Filter Ford TSA 110-
135 - 2 Filter Model T6000
T7000 T Series Primary
Filter 10mm Sensor

43593
- Water in Fuel Sensor M10



41254
Fuel Filter Ford TS110A
TS125A TS135A 2
FILTER MODEL T SERIES
SECONDARY FILTER
OTHER FILTER 41611



43496
Fuel Filter Ford T5105
Primary
OE Ref: 47450037

41862
Fuel Filter
Ford TSA



42231
Fuel Filter Ford
T6080 T6090 T7030
T7040 T7050 T7060
14mm Sensor is
43594



43594
- Water in Fuel Sensor M14

43004
Fuel Filter Ford
T Series After
Engine No 710



43497
Fuel Filter
Ford T5105
Secondary
OE Ref:
47450038



52366
Fuel Filter Spin On Case
Magnum 215 245 275 305
335 MX225 MX250 MX280
MX285 MX310 Steiger
280 330 Ford T8010 T8020
T8030 T8040 T9010 T9020
OE Ref: 87360565



52362
Fuel Filter Spin On
Case Steiger 380 385
430 435 485 AFX8010
STX380 STX530 Ford
FX30 FX40 FX48 T9030
T9040 T9050 OE Ref:
84818744



52361
Fuel Separator Spin On
Case STX380 STX485
STX530 Ford T9030
T9040 T9050 Massey
Ferguson 8570 8780
OE Ref: 87410186



Filters

Filter Kits



43707
Filter Kit T6 Series

3x Air, 1 x Engine, 1 x Fuel ,
1 x Pre Fuel 2 x Hydraulic



43475
Filter Kit New Holland **T5060**

2 x Air, 1 x Engine, 1 x Fuel , 1 x
Hydraulic



43476
Filter Kit New Holland T6010 T6020

2 x Air, 1 x Fuel, 1 x Engine, 2 x
Fuel, 1 x Hydraulic



43477
Filter Kit New Holland
T6010 T6020 Open
Centre

2 x Air, 1 x Engine, 2 x Fuel, 2 x Hydraulic



43478
Filter Kit New Holland
TL100A TL70A
TL80A TL90A TL80A
TL90A

2 x Air, 1 x Engine, 1 x Fuel, 1 x Hydraulic



43479
Filter Kit New Holland T7050 T7060

2 x Air, 1 x Engine, 2 x Fuel, 2 x Hydraulic



43480
Filter Kit New Holland
TS100A Delta

2 x Air, 1 x Engine, 1 x Inline , 1 x Fuel, 2 x Hydraulic

Filter Kits

43481
Filter Kit T6030 CCLS



2 x Air, 1 x Engine, 2 x Fuel, 2 x Hydraulic

43482
Filter Kit T6030 CCLS



2 x Air, 1 x Engine, 1 x Fuel, 2 x Hydraulic

43483
Filter Kit T6030 Open
Centre



2 x Air, 1 x Engine Oil, 2 x Fuel, 2 x Hydraulic

43484
Filter Kit T6030 Open
Centre



2 x Air, 1 x Engine, 2 x Fuel, 2 x Hydraulic

43485
Filter Kit TS100A Plus &
Deluxe CCLS



2 x Air, 1 x Engine, 1 x Inline, 1 x Fuel, 2 x Hydraulic

43486
Filter Kit TS100A Plus &
Deluxe Open Centre



2 x Air, 1 x Engine, 1 x Inline, 1 x Fuel, 2 x Hydraulic

Filter Kits



41274
Filter Kit Ford 7610

2 x Air 1 x Fuel 1 x Engine 2 x Hydraulic
1 x P Steering Pump Filter 1 x Water Coolant



41276
Filter Kit Ford TW5 TW10 TW15 TW20

2 x Air 1 x Fuel 1 x Engine 2 x Hydraulic



41277
Filter Kit Ford TW25/30

2 x Air 1 x Engine 1 x Fuel 2 x Hydraulic



41295
Filter Kit Ford 40's SLE

2 x Air 1 x Engine 1 x Fuel 3 Hydraulic



41296
Filter Kit Ford 40's SL

2 x Air 1 x Engine oil 1 x fuel 2 x Hydraulic



41279
Filter Kit Ford 60 - Electrical Fuel Pump

2 x Air 1 x Engine 2 x Fuel 2 x Hydraulic



41275
Filter Kit Ford 7810-8210

2 x Hydraulic 2 x Air 1 x Engine 1 x Fuel
1 x Power Steering Pump Filter 1 x Water Cool



41283
Filter Kit Ford M135 M160 Electric Lift Pump

2 x Air 1 x Engine 2 x Fuel 3 x Hydraulic



41284
Filter Kit Ford TS80

2 x Air 1 x Engine 1 x Fuel 1 x Hydraulic

Filter Kits



41285
Filter Kit Ford TS90 TS100 TS110 TS115 SL
Dual Power

SL Dual Power 2 x Air 1 x Engine 1 x
Fuel 3 x Hydraulic



41286
Filter Kit Ford TS115A TS125A TS135A

2 x Air 1 x Engine 1 x Fuel 2 x
Hydraulic



41287
Filter Kit Ford TS100A TS110A

2 x Air 1 x Engine 1 x Fuel 2 x
Hydraulic



41289
Filter Kit Ford TM120

22 x Air 1 x Engine Oil 2 x Fuel 3 x
Hydraulic



41290
Filter Kit Ford TM125

2 x Air 1 x Engine Oil 2 x Fuel 3 x
Hydraulic



41291
Filter Kit Ford TM130 TM140

22 x Air 1 x Engine 2 x Fuel 3 x
Hydraulic



41293
Filter Kit Ford TM115 Electronic & TM150

22 x Air 1 x Engine 2 x Fuel 2 x
Hydraulic



41294
Filter Kit Ford TM165 TM135 TM150

22 x Air 1 x Engine 2 x Fuel 2 x
Hydraulic



42059
Filter Kit Ford TS90 100 110 115 SLE

SL Dual Power 2 x Air 1 x Engine 1 x
Fuel 3 x Hydraulic

Date:.....

No. of Pages:.....

Name of the Rep.....

A/C Number:.....

From:.....

e-mail.....

Phone No.:.....

Fax No.:.....

Please quote for the following parts - Quotation Number :

I wish to confirm the following order on Quotation Number:

Please supply the following parts:

Qty	Part No.	Description	Unit Price
1.			
2.			
3.			
4.			
5.			
6.			
7.			
8.			
9.			
10.			
11.			
12.			
13.			
14.			
15.			
16.			
17.			
18.			
19.			
20.			
21.			
22.			
23.			
24.			

Please photocopy this page

Please do not remove this page

Comments:

Customer Signature:

Rep's Signature:

Tel No: + 353 44 934 1638

e-mail: info@qtponline.com, www.qtponline.com

Page of

Track Rod Ends Drag Link Ends



4262
Track Rod End Ford 550 -
555 LH



4009
Track Rod End P/S 5000 6600
7000 7600 Screw in



1369
Track Rod End Ford 550-555
LH - Ram



1368
Track Rod End Ford 550-
555 RH - Ram



41152
Seal Kit Ford 555 655
Loader Ram



41160
Power Steering Ram Seal
Kit Ford 550/555/655



41155
Ford 555/655 Torque Pump



02474/20
Wheel Bearing Ford 550
Outer

Dexta/2000/3000 2WD

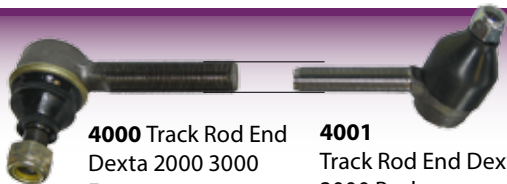

4000 Track Rod End
Dexta 2000 3000
Front

4001
Track Rod End Dexta 2000
3000 Back



780145
Track Rod End
Ford 2610 3610 4110
4610 LH

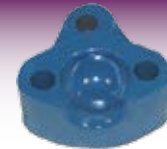

41380
Radius Ball Lower
Cap Ford 2000 -
3600



41381
Radius Upper Cap
Ford 2000 - 3600

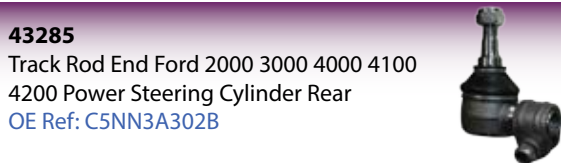

43285
Track Rod End Ford 2000 3000 4000 4100
4200 Power Steering Cylinder Rear
OE Ref: C5NN3A302B

4000/4600

4004
Track Rod End Ford 4000 4600

1298
Track Rod End
Ford 4610 Front
Push in



61329
Track Rod End
Clamp 165 188 590
290



2217 Drag Link 4000
4600

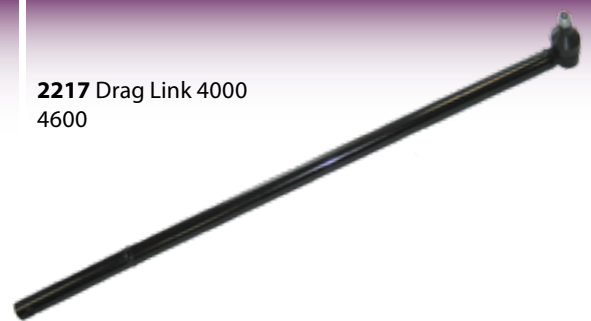

4002
Track Rod End Ford 4000
4600 Screw In



42170
Track Rod End Threaded Bar
3430 3930 4130 4630 4830 5030
4000 4600 4610



2442
Track Rod End Ford 4000 Tube
Suits Manual Steering Also fits
Models 4100 4330 4340



4003 Track Rod End Ford
4000 4600

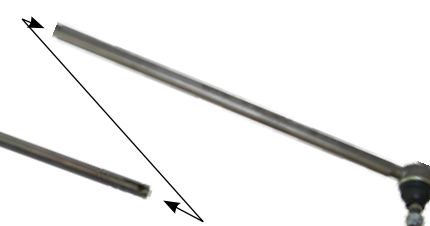

Axle Parts

Track Rod Ends

5000/6000/7000 2WD Manual



41437
Track Rod End Ford 5000 7000
Manual LH



4005
Track Rod End Ford 5000 7000 Drag
Link Manual



4007
Drag Link End
Ford 5000 7000
Manual RH

5000/6600/7000 2WD Power Steering



4010
Track Rod End Ford 5000-
7000 P/S LH Power Steering
ZF axle only



4012
Track Rod End P/S 5000 7000
RH Push in Power Steering



4011
Track Rod End P/S 5000 7000
6600 7600 Tube



4009
Screw In
T.R.E.

ZF 4WD



4008
Drag Link Ford 5000 7000
P/S



1383
Track Rod End Ford ZF 4WD Axle

5700/6710/7710/9700 2WD



1370
Track Rod End Ford
5610 8210 TW 2WD
RH Outer TW10 TW15
TW20 TW 25 TW30
TW35 TW5



1346
Track Rod End Ford 77-8210, TW's
2wd LH Outer



1372
Track Rod End Ford 5700 9700
TW RH Inner

1381
Track Rod End Ford 5700 9700
TW LH Inner

Boot Seals

41390
Track Rod End Boot Seal Ford - Large
OD 47 ID 36 Fit Diameter 40

41391
Track Rod End Boot Seal Ford - Small
OD 45 ID 32 Fit Diameter 37

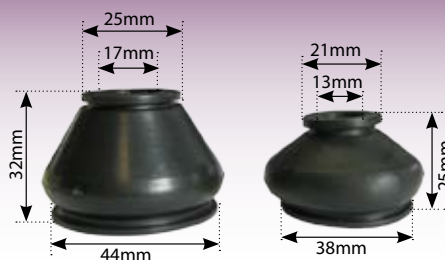

Track Rod Ends 5610/6610/7610 2WD



4541
Track Rod End Ford
6610 7610 2WD
Inner



4540
Track Rod End Ford
6610 7610 2WD RH
P/S Ram



4542
Track Rod End
Ford 6610 7610
2WD LH Outer

4543
Track Rod End Ford 10 RH 32mm Outer



2819
Track Rod End Ford 10 30mm RH Outer

8210 4WD Series Carraro



22R

24R

3144
Ball Joint Ford 8210
Carraro 4WD



3142
Track Rod End Ford 8210
RH Carraro 4WD



22R

24L

2825
Ball Joint Case
Maxxum Ford 40



3148
Track Rod End Ford 8210
LH Carraro 4WD

6610/7810 4WD Series Carraro



20r

18r

6463
Ball Joint 300 4200 Ford 4WD New Type
John Deere 2400 - 2600 - 2850 - APL325 APL735
Case CS 4 Cylinder



2186
Track Rod End Ford 6610 7810 4WD RH Carraro A



20r

18L

4255
Ball Joint Ford 10 Carraro Axle LH LH Thread
Also fits Case IHC 4200 95 CS CX



2187
Track Rod End Ford 6610 7810 4WD LH Carraro

Axle Parts

Track Rod Ends & Ball Joints

7610/8210 4WD Series ZF APL 345/350



6463
Ball Joint 300 42's - Ford 4WD - New Type



41402
Track Rod End Assy RH Ford 56 66 7610 ZF325 APL325 APL335
** LH is 42256 **



42256
Track Rod End Ford 5600 6600 7610 LH
** RH is 41402 **



1701
Track Rod End Ford 7610 8210 APL 345 350 LH 8
** Does not suit 7910 **



1700
Track Rod End Ford 7610 8210 APL 345 350 RH 8

TW25 (APL 365)



3129
Track Rod End Ford TW25 APL 365



3176
Ball Joint Ford TW25 APL 365



3135
Track Rod End Ford TW25 APL 365

TW5/15/25 (APL 345,355)

3144
Ball Joint Ford 8210 Carraro 4WD
MX,Maxxum, Mf3000 & 6100 Rh Thread



Track Rod Ends & Ball Joints 40's/TS Track Rod Ends 2WD



41084
Track Rod End Ford 40 TS 2WD RH P/S Ram
5640 6640 7740 7840 8240 8340

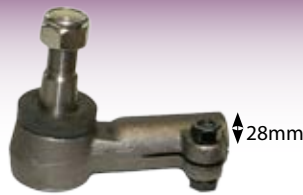

41083
Track Rod End Ford 40 TS 2WD Outer
Screw in



41085
Track Rod End Ford 40 TS 2WD LH
Outer



41082
Track Rod End Ford
40 TS 2WD Outer
Push in



42063
Track Rod End Ford 8160 8560
M100 - M160 TM115 - TM165 ALL
2WD M32 Thread



42073
Track Rod End Ford RH 6635 7635 TL TLA T5000

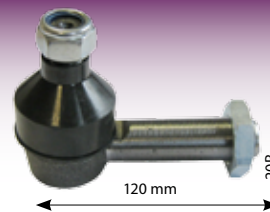

42074
Track Rod End Ford LH
66/7635 TL TLA T5000 Case
JXU Fiat L65 95

40's/TS TRE 4WD



3144
Ford 40 'S Carraro 4WD
Ball Joint (Right Hand Thread)



41021
Half Nut Fiat & Ford Ball Joint



2825
Ford 40 'S Carraro 4WD
Ball Joint (Left Hand Thread)

40's TRE Carraro



Ball Joint = 3144
404286
Track Rod End
Ford 8200 8340
LH Carraro Axle



Ball Joint = 2825
404285
82/8340 R.H.Tre
Track Rod End
Ford 8200 8340
RH Carraro Axle

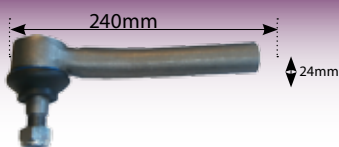

Ball Joint = 3144
409867
7840 Carraro LH
Track Rod End Ford
5640-7840 Carraro
LH

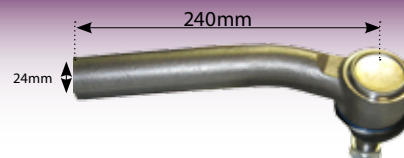

Ball Joint = 2825
409868
Track Rod End Ford
5640 - 7840 Carraro
RH

Track Rod Ends & Ball Joints

7610/8210 4WD Series ZF APL 345/350



41203
Steering Cylinder Ford 5640-8340 2wd



41164
Cylinder Rod Assembly Ford 40
For 41203 Ram



3312
Stub Axle Bearing Ford
5000 5600 6600
Also fits 700 7600



353928
Wheel Nut 3/4' UNF
Castle Head

1249
Spindle Ford 40 4 Cylinder
Also Fits Ford 5640 6640 7740
7840 8240 8340 ** 1159 Is Wheel
Bearing Kit



180010
Tab Washer for Front
Axle



41035
Spindle Bush Ford 40 TS TW
7710 7810 Top



41033
Spindle Bush Ford 40 TS
TW 7710 7810 Bottom



1159
Wheel Bearing Kit Ford
5000 6610 7610



4605
Orbital Unit Ford 40 TS 4WD
M18 -12 Spline 24.25mm
Diameter 20mm high



2313
Solenoid Valve
Ford 30 40 7610
7810 6410 4WD



409793
Ram Locking Ring Ford 40
60 TM TS 4WD



409783
Hub Seal Ford 40 Fiat
110-90 Outer Small
45-68-12

41207
Stub Axle Ford ZF IHC John Deere 4WD

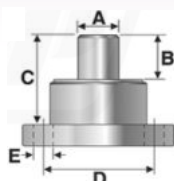

A	23mm
B	18mm
C	40mm
D	55mm
E	13mm

41206
Stub Axle Ford ZF IHC JD 4WD 7610 7710 7910 8210 TW 5 / 15 / 25 Case 956 1056 JD 3050 3350 3650

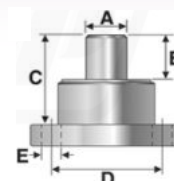

A	25mm
B	25mm
C	48mm
D	58mm
E	13mm

Track Rod Ends & Ball Joints

APL 2045





Z307008
Crown Reduction
APL 2045

Z306031
Central Pinion APL 2045

Z306183
Satellite Gear
APL2045

Driveline and Chassis Technology 

Makes & Models
John Deere - 6506, 6600, 6800, 6610, 6810
Fendt - 312 Ls Farmer, 512C, 514C
Deutz - Agrottron 6.20

APL 325





4047
Ring Gear Ford 10
Case 395-595 John
Deere

4048
ZF Axle Shaft Ford
10

4563
Gear Ford 10 & John Deere 2040 - 2650
Also fits IHC 395 - 595 ZF Axle

Makes & Models
John Deere - 1640, 2040, 2250, 2450, 2650
Ford - 5610, 6610, 6710, 7710
Case Ih - 844XI

APL 1351



IH101K
Drive Shaft - APL1351

IH071351F
Hub Carrier Shaft For
Axle - APL1351

Makes & Models
John Deere - 1640, 2040
Ford - 5600, 6600, 6700
Deutz - 6806, 7206
Fendt - 306 Ls
Steier - 8080

APL 1251



Z356005
Axle Pivot - APL1251

Makes & Models
Case I.H. - 533, 633, 645, 733
Fendt - 1045

APL 3052-3054



Z353016
Stud Bearing Pivot - APL 3052-
3054

Makes & Models
John Deere - 1640, 2040,
2250, 2450, 2650
Case Ih - 1255, 1455

APL 335





Z352095
Axle Housing - APL335
LH - Late Type

Z352096
Axle Housing - APL335
RH

Makes & Models

Case Ih - 745, 845, 856
Ford - 5610, 6610, 6710, 7610, 7710

APL 1551-1552



Z354007
Stud Bearing Pivot

Makes & Models
John Deere - 1640, 2040, 2250, 2450, 2650 /2140
Case Ih - 845/ 955, 956, 1055, 1056
Ford - 7700
Steier - 8100
Fendt - 308Ls, 309 Ls

APL 2035-2045





51692
ZF Axle Circlip
(APL2035)

51704
ZF Axle Sun Gear Outer
Bearing (APL2045)

51696
Seal John Deere 00s 10s
20s Inner & Outer Hub
Front Axle 66.15 x 91 x
12.5/14

51699
ZF Axle Sun Gear Inner
Bearing (APL2045)

Major Front Axle

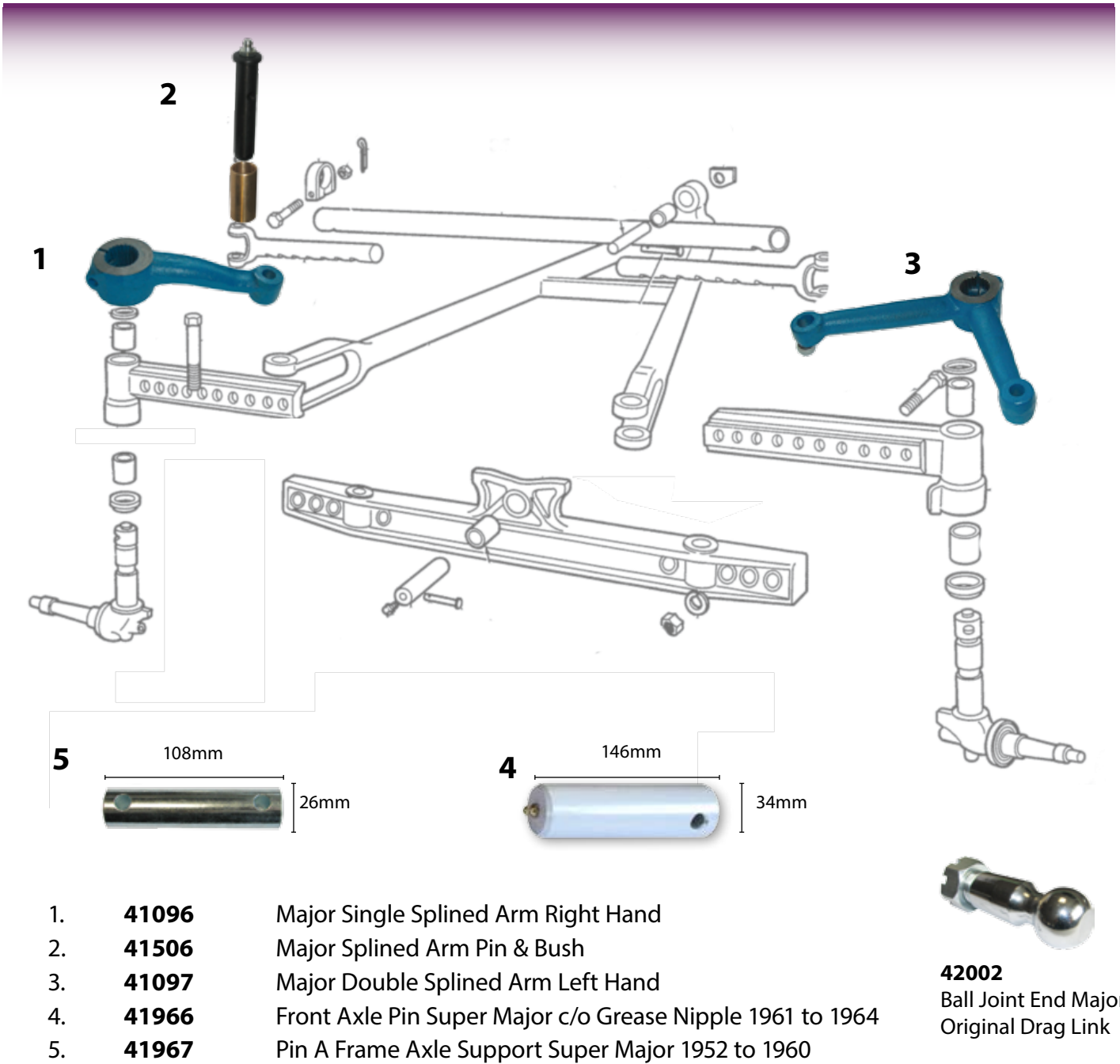

- 1. **41096** Major Single Splined Arm Right Hand
- 2. **41506** Major Splined Arm Pin & Bush
- 3. **41097** Major Double Splined Arm Left Hand
- 4. **41966** Front Axle Pin Super Major c/o Grease Nipple 1961 to 1964
- 5. **41967** Pin A Frame Axle Support Super Major 1952 to 1960



Dexta



41965
Axle Pin Dexta

41989
Bush Dexta Front Axle Super Dexta

2000, 3000 Front AXLE

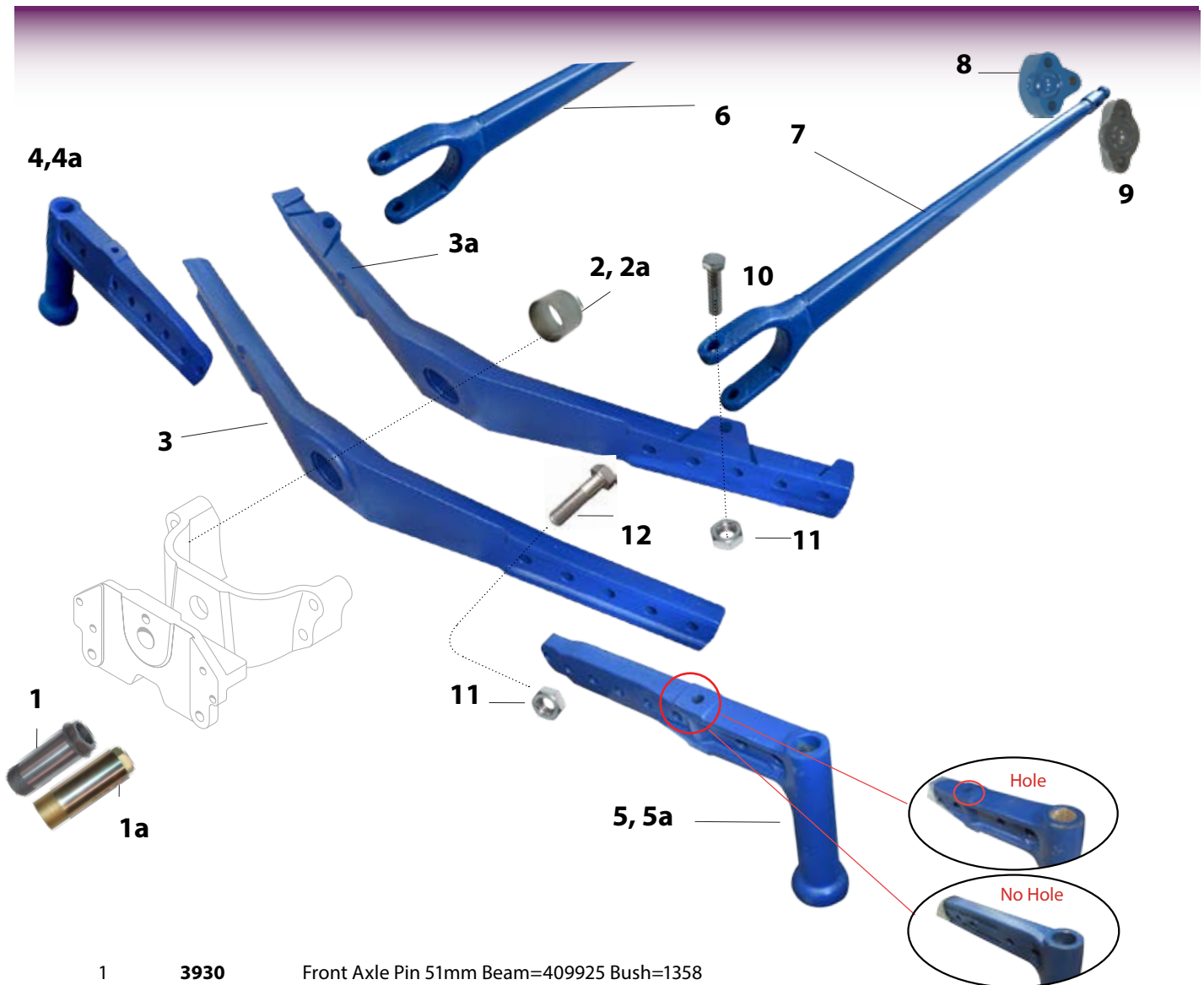

1	3930	Front Axle Pin 51mm Beam=409925 Bush=1358
1a	41026	Front Axle Pin 44mm Beam=409924 Bush=409923
2	1358	Front Axle Pin Bush 51mm
2a	409923	Bush Front Centre Axle Ford 2000 3000 1 3/4" 45mm
3	409925	Axle Beam Front Centre Ford (51mm Centre Hole)
3a	409924	Axle Beam Front Centre Ford (44mm Centre Hole)
4	41063	Front Axle Support Right Hand
4a	41929	Front Axle Support Right Hand Old Type No Hole
5	41930	Front Axle Support Left Hand Old Type No Hole
5a	41064	Front Axle Support Left Hand
6	41824	Radius Bar Right Hand Has Hole For P/S Ram
7	41826	Radius Bar Left Hand Has Hole For P/S Ram
8	41380	Radius Ball Lower Cap Ford 2-3600
9	41381	Radius Upper Cap Ford 2-3600
10	353639	Bolt 5/8" x 5" UNF Zinc & Yellow
11	353427	Nut 5/8" UNF Zinc & Yellow To Suit Rim to Disc Stud
12	353627	Bolt 5/8" x 3 1/2" UNF Zinc & Yellow

Axle Parts

ZF APL 325 LH Axle Parts

APL 2045-345

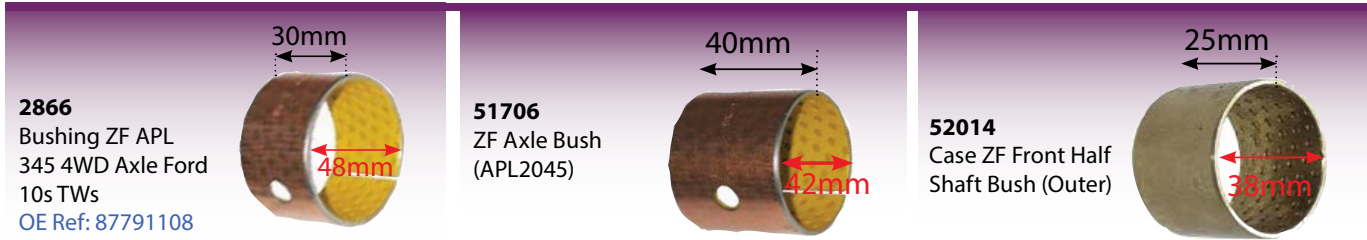

7610, 7710, 8210 Q Cab Up to 1985

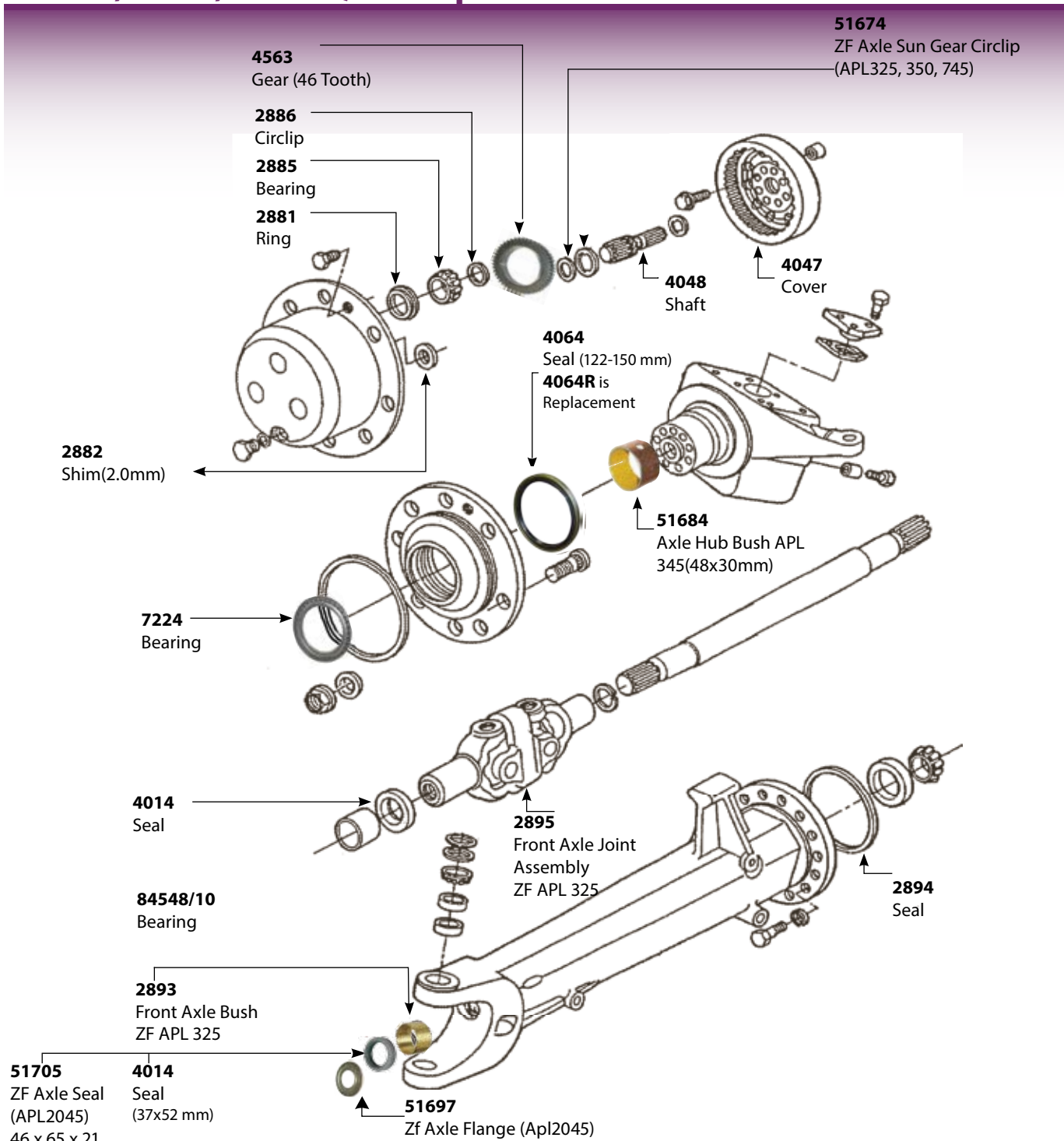

ZF APL 325 LH Axle Parts

41207

Stub Axle Ford ZF IHC John Deere
4WD



A 23mm
B 18mm
C 40mm
D 55mm
E 13mm

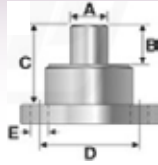

41206

Stub Axle Ford ZF IHC JD 4WD



A 25mm
B 25mm
C 48mm
D 58mm
E 13mm

41205

Stub Axle Ford 5610 59mm
6610 6810 ZF IHC JD
4WD 6410 7610 JD
2850

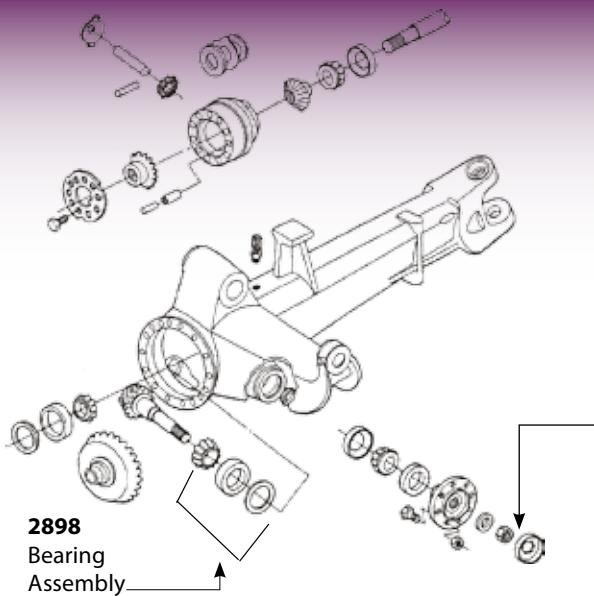
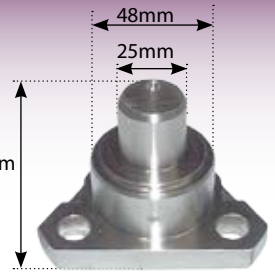

409823

Pivot Ford 40's / Case
Carraro Lower
Also Case CX70/80/90
5120-50 / 580 50HX

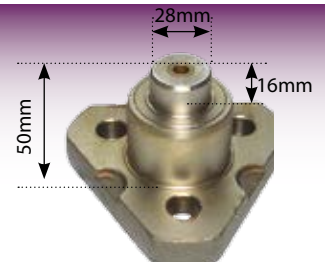

51674 ZF Axle Sun Gear Circlip
(APL325, 350, 745)

51693 ZF Axle Circlip (APL2035)

51695 ZF Axle Circlip (APL2045)



4563
Ford APL 325
Axle Gear



2334
Seal Kit APL 345
350 AXLE



4925
Switch Ford TW 10 30
4WD ZF



51690
U Joint ZF Axle APL1251 1351
315 345 30 x 83
NOT FOR 335 -- 30 MM CAPS
WITH GREASE HOLE



51697
ZF Axle Flange (APL2045)



51682
ZF Axle Satellite Gear -
APL335

51689
ZF Axle Universal Joint Yoke
(APL345, 350)



51691
ZF Axle Universal Joint Yoke
(APL345, 350)



41074
Ford 10' ZF Axle
Shaft (APL335)



51705
ZF Axle Seal (APL2045)



51680
ZF Axle Crown Reductor
(APL335)

ZF APL 345 Axle Parts

7610, 7710, 8210 Q Cab Up to 1985

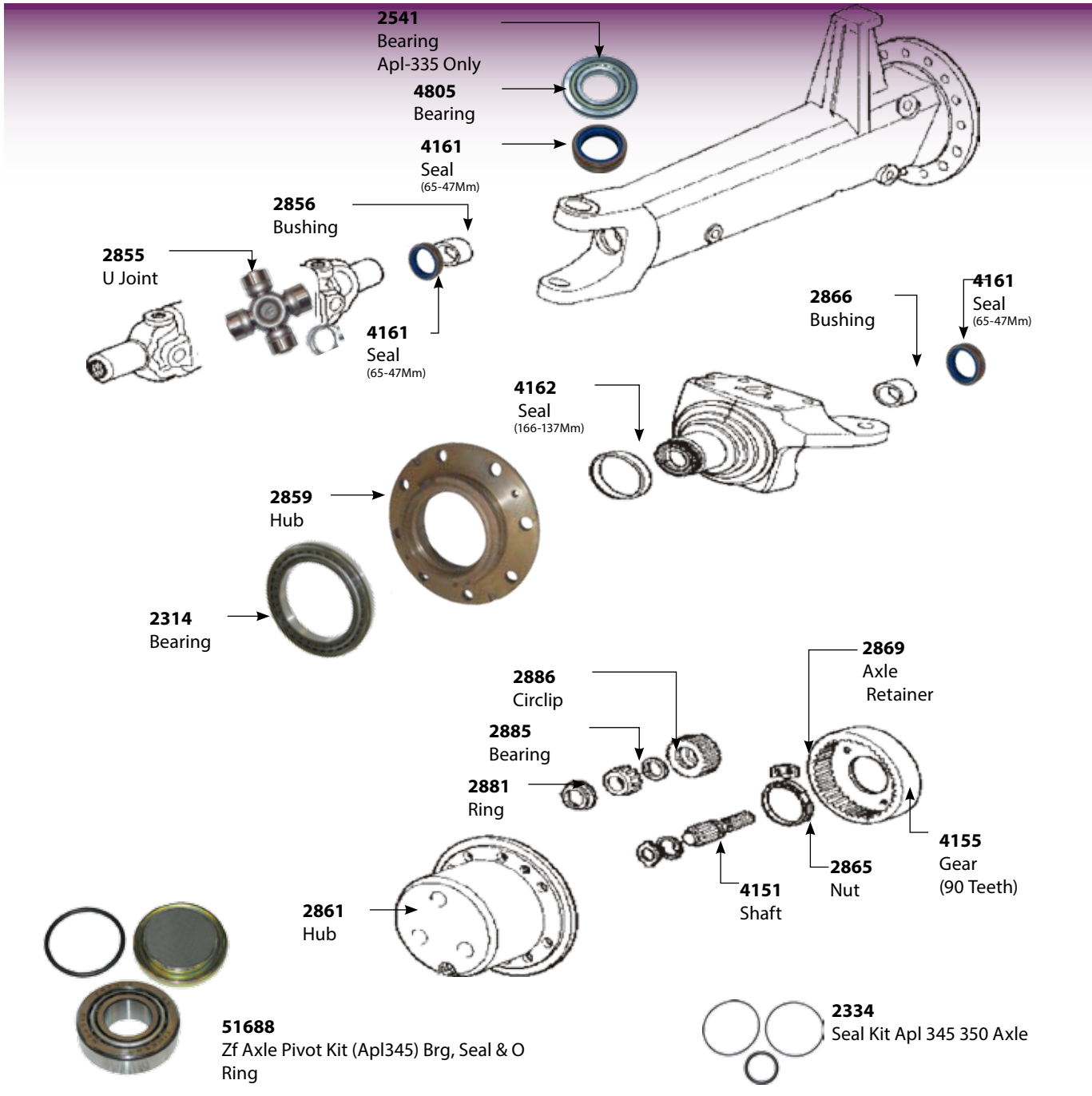

1700
7610-8210 APL 345/350
R.H. T.R.E



6463
7610-8210
LH & RH Ball Joint



1701
7610-8210 APL 345/350 L.H.
T.R.E

Pivot Housings

42982

Front Axle Joint Assembly APL335
Ford 7610 Case 685 995

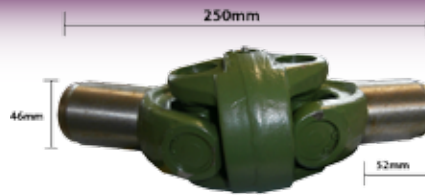

42979

Pivot Housing APL345-350 RH
Ford Case



42980

Pivot Housing APL345-350 LH
Ford Case



59146

Pivot Housing APL345 350 LH
John Deere 3040 3140 3050
3350



42985

Pivot Housing CAR709S2 New
Holland 5640 6640 7740 7840
LH



42984

Pivot Housing CAR709S2 New
Holland 5640 6640 7740 7840
RH



10's Carraro

42987

Pivot Housing CAR709 Ford
5610 6610 7610 LH



42986

Pivot Housing CAR709 Ford
5610 6610 7610 RH



43057

Crown Wheel & Pinion Ford 5610 6410 6610 6810 7610
7710 7810 7910 Carraro 11/32 Teeth



401757

Power Steering Ram Seal Kit
Ford 10 Carraro Axle



40'S Carraro Axle

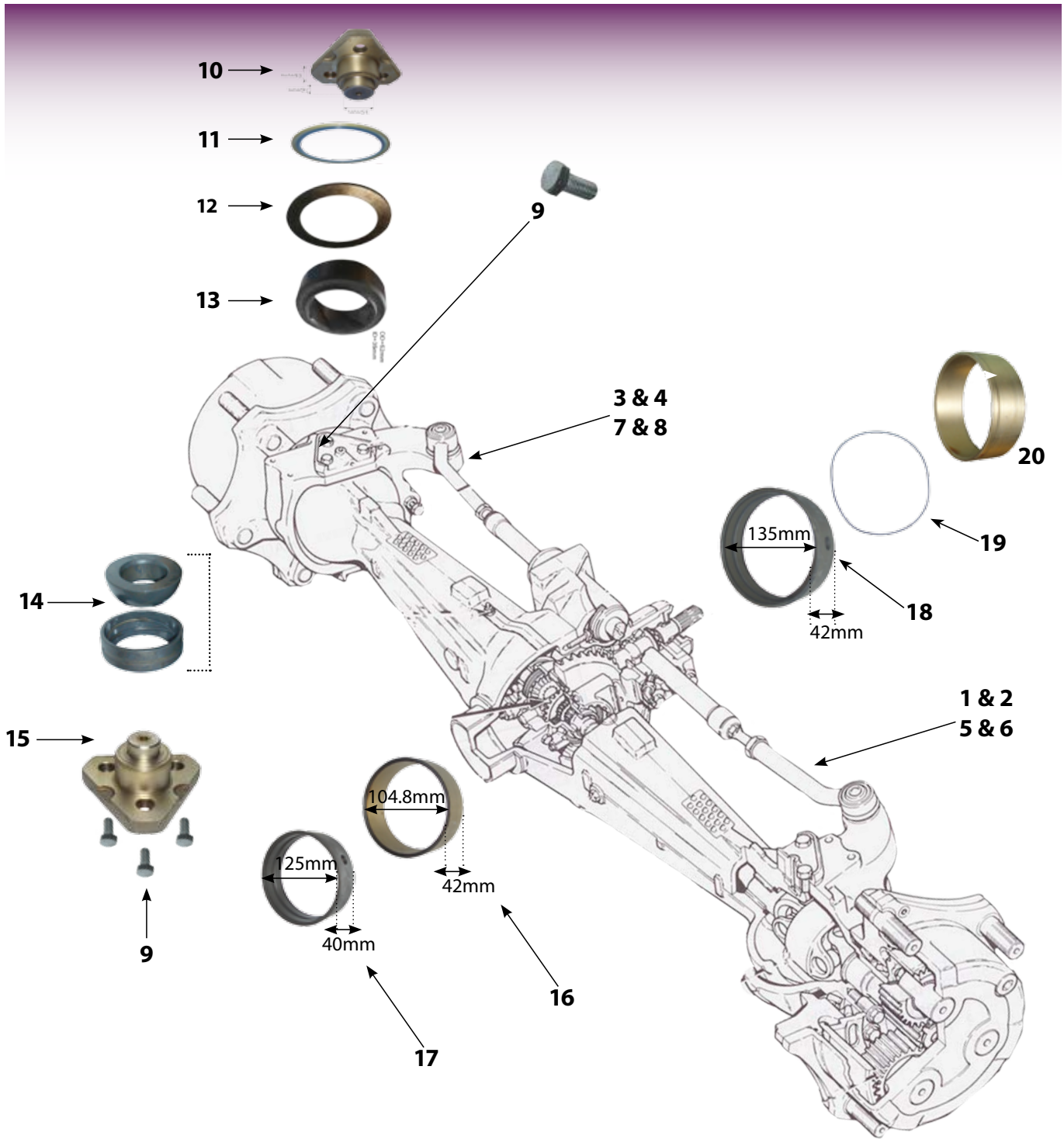

409816
Power Steering Ram Seal
Kit Ford 40 Carraro



40'S Carraro Axle

LH

8240 8340

RH

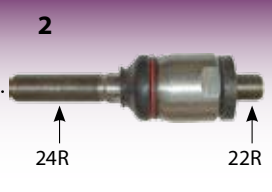
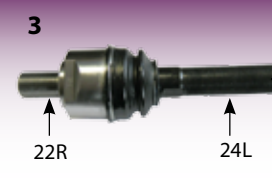
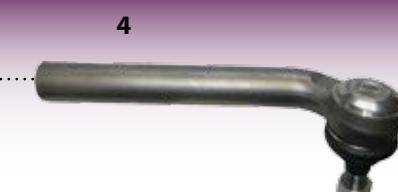
 <p>1</p> <p>404286 Track Rod End Ford 8200 8340 LH Carraro Axle (3144 Ball Joint)</p>	 <p>2</p> <p>3144 8210 (Carraro Axle) 4WD Ball Joint</p>	 <p>3</p> <p>2825 8210 (Carraro Axle) 4WD Ball Joint</p>	 <p>4</p> <p>404285 Track Rod End Ford 8200 8340 RH Carraro Axle (2825 Ball Joint)</p>
---	---	--	---

LH

5640 6640 7840

RH

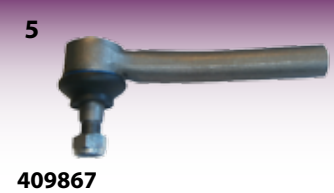
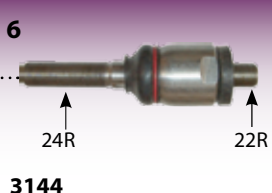
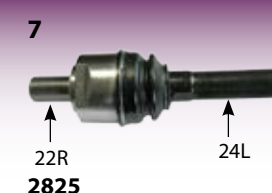
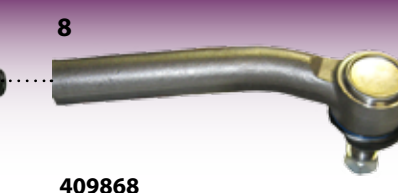
 <p>5</p> <p>409867 Tre Ford 5640 6640 7840 Carraro LH (3144 Ball Joint)</p>	 <p>6</p> <p>3144 8210 (Carraro Axle) 4WD Ball Joint</p>	 <p>7</p> <p>2825 8210 (Carraro Axle) 4WD Ball Joint</p>	 <p>8</p> <p>409868 Track Rod End Ford 5640 - 7840 Carraro RH (2825 Ball Joint)</p>
---	---	--	--

<p>9</p>  <p>3637 Bolt M14 x 30 Coarse Zinc Plated</p>	<p>10</p>  <p>409870 Stub Axle Ford 40 Carraro Upper Stud Pivot</p>	<p>11</p>  <p>409841 Pivot Seal Ford 40 Carraro Axle 62 x 50 x 9mm</p>	<p>12</p>  <p>43258 Thrust Washer Front Axle Ford 10s 40s Case CS CX MX ** Suits 409821 & 409822 **OE Ref:3541397M1</p>	<p>13</p>  <p>409824 Stub Axle Bearing Ford 40 Carraro 860 50HX</p>	<p>14</p>  <p>1182 Stub Axle Bearing Carraro Ford 4WD/50HX</p>	<p>15</p>  <p>409823 Pivot Ford 40's / Case Carraro Lower</p>	<p>16</p>  <p>409822 Front Axle Wear Sleeve Ford 40 Case Carraro Also Case CX70/80/90 ** Suits 43258 ** ID 104.8mm, OD 114.9mm</p>	<p>17</p>  <p>409821 Front Axle Bush Ford 40 Carraro 125 x 40mm</p>	<p>18</p>  <p>409817 Front Axle Bush Ford 40 Carraro 5610 5640 6610 7610 7810 8210</p>	<p>19</p>  <p>409818 Front Axle O Ring Ford 40 Carraro</p>	<p>20</p>  <p>409819 Front Axle Bush Ford 40 Carraro Inner 5610 5640 6610 7610 7810 8210</p>
						<p>2313 7810 Carraro 4 W.D. Switch</p> 	<p>409910 Solenoid Switch Ford 40 4WD - Fiat Axle</p> 				

40'S Carraro Axle

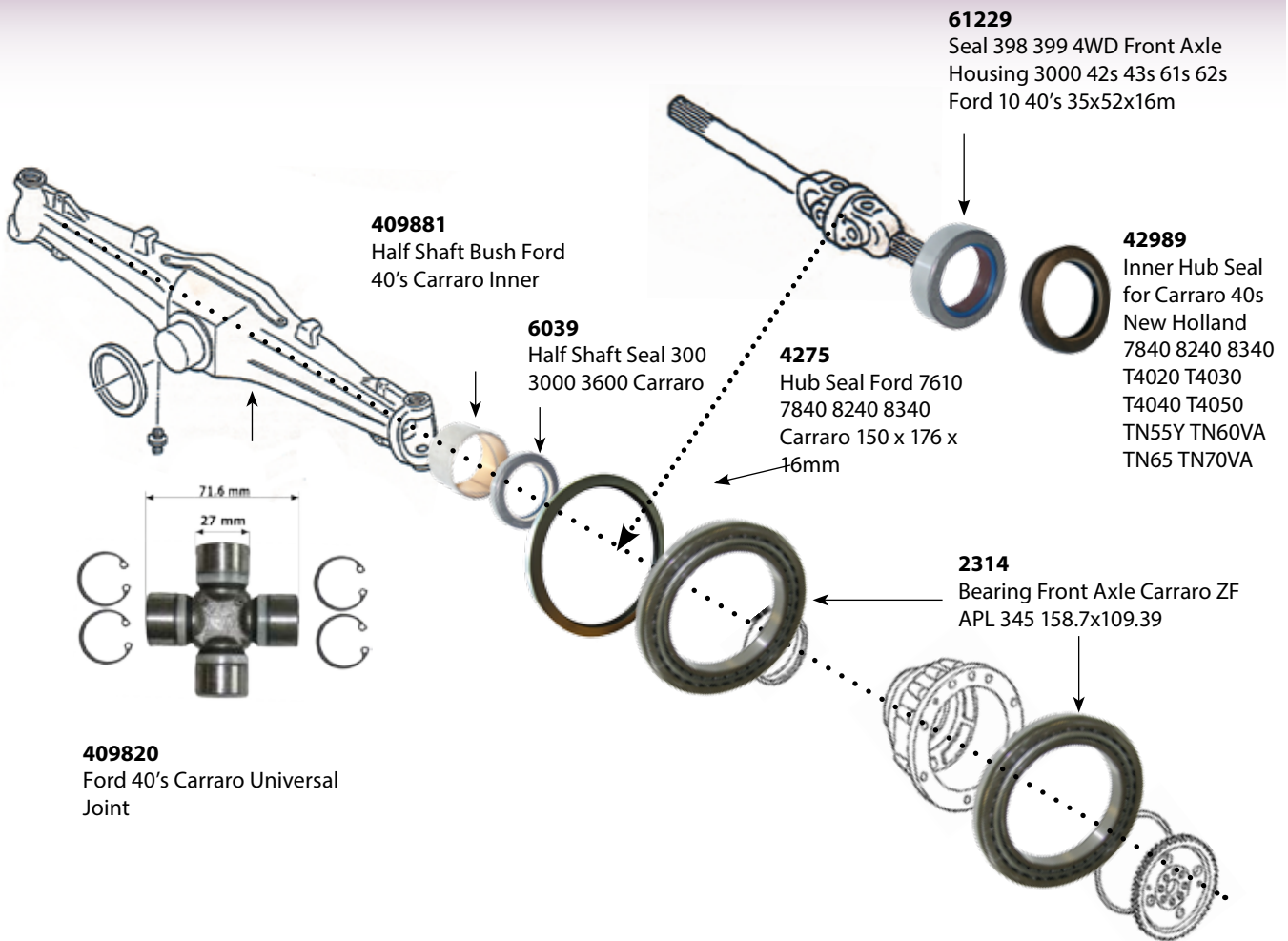

When Fitting Gear Make Sure You Are Fitting The Correct Gear With The Correct Amount Of Teeth

403963
Gear Ford 5640 8340 TS100 TS115 4WD 37
Teeth

403964
Gear Ford 5640 8340 TS100 TS115 4WD 38
Teeth

403965
Gear Coupling Ford 7840 4WD

42974
Centre Yoke Drive Shaft
Ford 6810 7610 7710 8

52430
Front Axle Joint Assembly Case 5220
5230 5240OE Ref: 81863155

When Working On 40'S/Ts's 4Wd Gears The Seals Needed To Reseal The 4Wd Unit Are 4831 X 1 4873 X 1 4830X 1 4907X 1 409791 X 1

40'S Carraro Axle

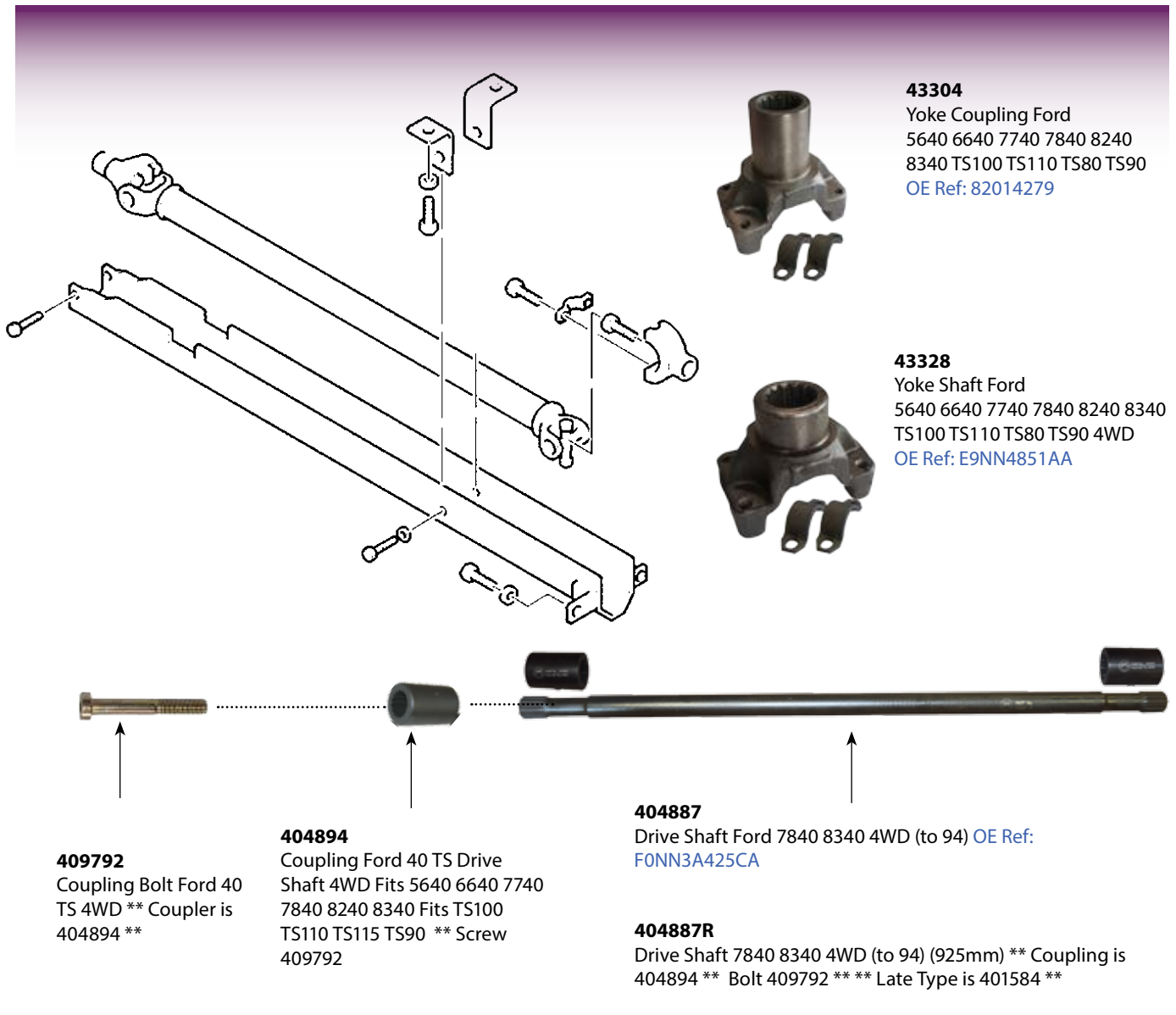

43304
Yoke Coupling Ford
5640 6640 7740 7840 8240
8340 TS100 TS110 TS80 TS90
OE Ref: 82014279

43328
Yoke Shaft Ford
5640 6640 7740 7840 8240 8340
TS100 TS110 TS80 TS90 4WD
OE Ref: E9NN4851AA

409792
Coupling Bolt Ford 40
TS 4WD ** Coupler is
404894 **

404894
Coupling Ford 40 TS Drive
Shaft 4WD Fits 5640 6640 7740
7840 8240 8340 Fits TS100
TS110 TS115 TS90 ** Screw
409792

404887
Drive Shaft Ford 7840 8340 4WD (to 94) OE Ref:
F0NN3A425CA

404887R
Drive Shaft 7840 8340 4WD (to 94) (925mm) ** Coupling is
404894 ** Bolt 409792 *** Late Type is 401584 **

31308
Wheel Bearing Crown Ford
40 Carraro

409814
Crown Wheel Nut
Ford 40 Carraro

41552
Crown Wheel & Pinion Ford
5640 6640 7740 7840 Carraro
(10 / 32 teeth)

41880
Crown Wheel &
Pinion Ford 8340
11/31 Teeth Carraro
Axle

61229
Front Axle Housing Seal
398/399 4WD 3000 42s
43s 61s 62s Ford 10 40's
35x52x16m
AG85 Axle up to
L14073/12481CM
AG105 Axle up to
L11040/10739CM

43047
Nut Crown Wheel &
Pinion Ford TM TL
TSA TD

43046
Seal Crown Wheel
& Pinion Ford TM TL
TSA TD Series

New Holland Axle

6912
Bearing & Carrier
2600 3000 3600 4WD
Shaft 6100 Ford T6000
TM TSA Fiat F M

43094
Bearing Support 4WD Shaft
TM130 8360 TM140 TM120
TM115 8160 TM125 8560
TM135 8260
OE Ref: 5170368

7587
Coupling Fiat 100-90 4WD 12
Spline Early Fits Fiat 80 90 F &
M Series

43554
Axle Coupling New Holland
TM120 - TM190 Middle
OE Ref: 5183663

43255
Four Wheel Drive Shaft
Bearing 35s TL TLA TN L
OE Ref: 5167098

43679
Drive Shaft 4WD Hi/Lo or Manual
Transmission TM Series Ford 60 Series
OE Ref: 5168037

7504
Rear Axle
Bush Fiat
4WD

43043
Bush Pivot Housing Ford 6635
7635 5640 6640 7740 7840 8240
8340 8160 8260 TD75D TD80D
TD90D TD95D TL Series TM
Series TS Series

7521
Front Axle Steering Knuckle
Plate Fiat 80-90

401584
7840/8340/TS 4WD
Drive Shaft (94 up)

41021
Fiat/Ford Ball
Joint Nut

7575
Pivot Housing Gasket 4WD
.15mm

42169
Track Rod End 5640 6635 6640
7635 7740 7840 TL80 TL90
TL1000 TL80A TL90A TL100A
TS80 TS90 TS100 TS110 TS115

1209
Track Rod End Ford 7840 Fiat

7513
Pivot Bearing Drive Fiat
110-90

41262
Track Rod End Fiat 8240 8340 8330
8360 1Ram A TM110 115 120 125
130 135 140 150 155 165

7505
Support Bush Fiat 580 - 1880
45-66 - 60-66

7509
Pivot Bearing Seal Fiat 110-90

7503
Front Axle O Ring TM TS
TL TSA Fiat 90/110-90
(5.33x53.34)

409755
Front Axle Beam Seal 40 TS M
TM Fiat 100-90 David Brown
995 1290, Kubota, 580F/G

3629
Bolt M14 x 100 Coarse Zinc & Yellow

409756
Front Axle Hub Seal
Ford 40 60 TM TS Inner

43619
Front Axle Shaft Ford 5635 6635 7635 8160 8260 40
Series 6010 6020 6030 6040 6050 6070 TD80 TD75
TD90 TD95 TL75 TL80
OE Ref: 5191549

409783
Ford 40's/Fiat 110-90 Outer
Small Hub Seal

42978
Seal Kit Power Steering
Ram Ford 30 35 40 Ser

43101
Drop Box Oil Seal 40
x 80 x 12mm TM155
TM120 TM130 TM135
TM140 TM150 TM115
TM165 TM175

409746
U Joint Ford New Holland TL TLA TM TS TSA T6
Fiat 110 90 4WD - Fiat Axle 27 x 82.7

409792
Ford 40's/TS 4WD
Coupling Bolt

404894
7840/8340 Dr.
Shaft Coupling

New Holland Axle

7306
Power Steering Ram
Bush Fiat 100-90
4WD
25mm ID



43275 Power Steering Cylinder
Ford 5635 6635 7635 New
Holland T5030 T5040 T5050
TD80 TD90 TD95 TD80D TD90D
TD95D TL100 TL70 TL80 TL90
TL100A **OE Ref: 5164023**
20mm ID

43277
Power Steering Cylinder Ford
New Holland T7030 T7040 T7050
T7060 T7070 TM175 TM190 4WD
Case IH MXM175 MXM190 Puma
165 180 195 210 **OE Ref: 5198883**
25mm ID



41991
Power Steering Ram Ford
40 TS TM Series
20mm ID

-or-

43267
Steering Cylinder Ford New
Holland T6000 Series
OE Ref: 87521950
20mm ID

-or-

60456
Power Steering Ram Fiat
580 980 60-90 110-90 2
Ram Axle 20mm Hole -
Ford Type is 41991
20mm ID

-or-

42944
Power Steering Ram Ford
60 F M TM
25mm ID



7459
Bush Ram Fiat 100-90
4WD Power Steering Also
fits Ford 7840 20mm
20mm ID

409753
Grease Nipple Ford Fiat 40'
Large for Ram Pin



7461
Power Steering Ram Pin
Fiat Inner 7840
20mm ID



43248
Power Steering Ram Pin
Outer 60s Ms T6s T7sTMs



41018
Power Steering Ram
Pin Ford 7840 Outer
20mm ID



43247
Power Steering Ram Pin Inner
60s Ms T6s T7sTMs



409793
Ford 40/60/TM/TS 4WD Ram
Locking Ring for 7459



New Holland Axle



TS TL TM TN Series

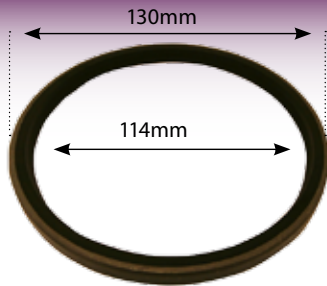

43082
Seal Front Axle Front Carrier 4WD
Ford TM's T7's



43083
Seal Rear Front Axle Bush
Ford TM
OE Ref: 5131232



43596
Bearing Front Mudguard New Holland T6010
T602 T6030 T6040 T6050 T6060 T6070 T6080
T6090 T7.170 185 200 210 Steyr 6160CVT
6145CVT OE Ref: 44908419



43248
Power Steering Ram
Pin Outer 60s Ms T6s
T7s TMs
OE Ref:5171707



43252
Universal Joint TMs 60s
Ms Front Axle
OE Ref:9967667



43554
Middle Axle Coupling
New Holland TM
OE Ref: 5183663



43251
Drop Box Seal Protector
90s 60s TMs TSAs OE
Ref:5109309



43602
Accumulator TM TSA T6s
T7s Front Axle Suspension
OE Ref: 87354713



43050
Bush Front Axle
Rear Carrier 4WD
Ford TM's T7 Fiat
115-90 to 180-90 and
F120-F140



43044
Bush Front Axle 4WD
Input Support
Ford 3435-7635 40's
60's TS TL TM TN
Series

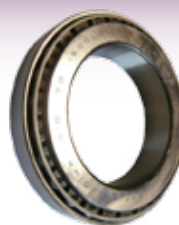

43049
Bearing Front Axle
4WD New Holland
60 TM TSA

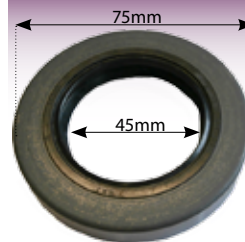

43045
Seal Crown Wheel &
Pinion Double Lip Ford
TM TL TSA TD Series
8240 8340



43542
Drive Shaft Seal 6000s
TMs TSs TSAs
42 x 62 x 21.5mm
OE Ref: 5177709

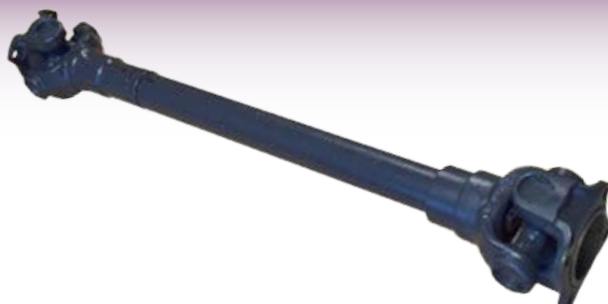

43578
Drive Shaft New Holland TM Series
** U-Joint is 43579 ** OE Ref:
8767450087674500

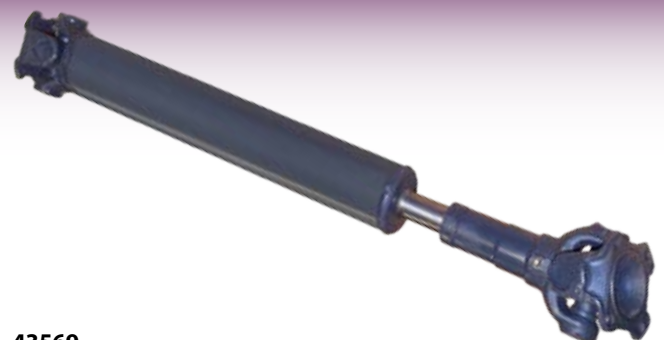

43569
Driveshaft New Holland TM120 TM130 TM140 TM155
TM175 TM190 OE Ref: 87393883

T6 T7 4WD Front Axle Drive Shaft

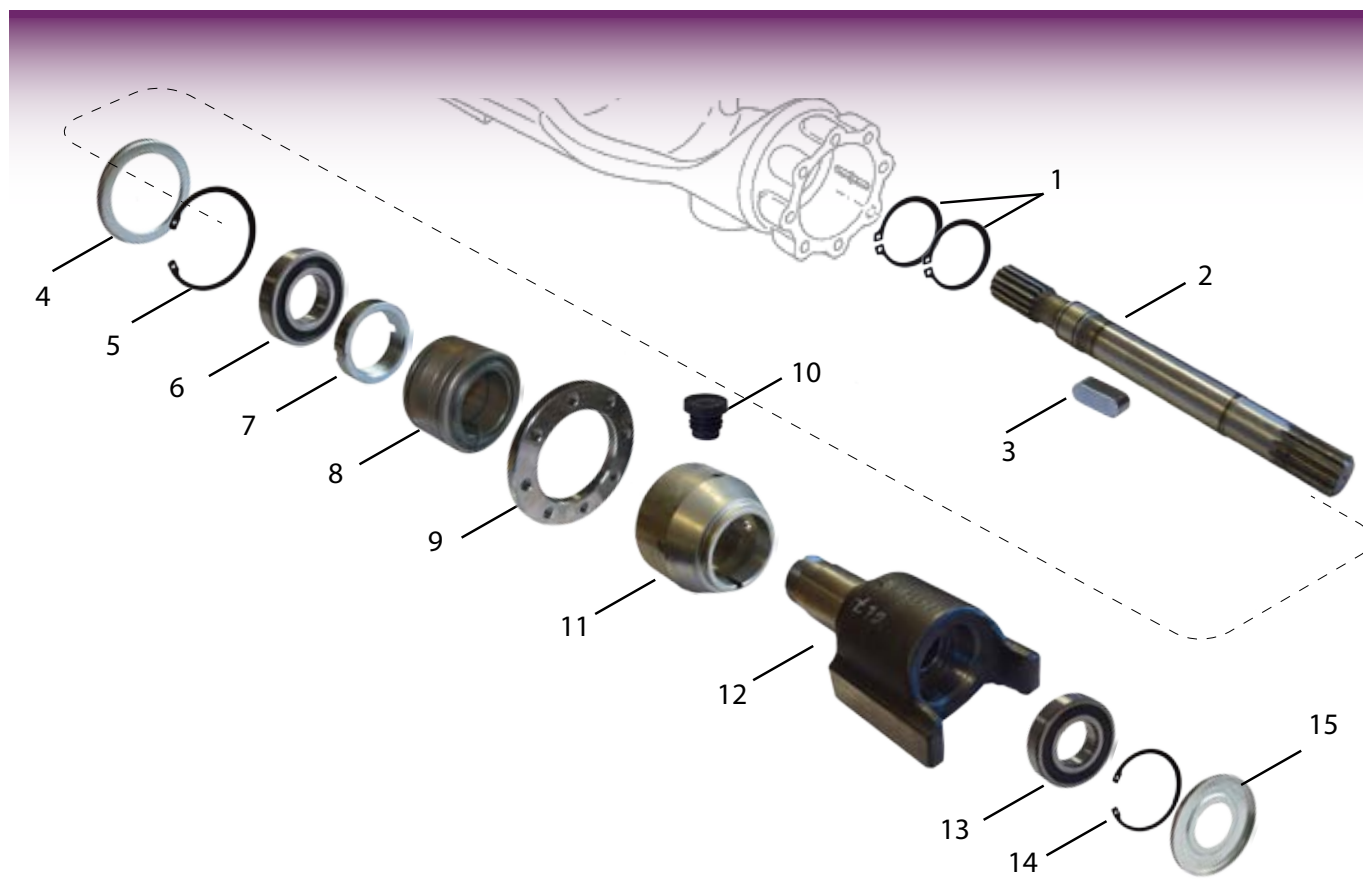

1	43573	Circlip M40 External TSA TM TL TD T7000 T7 T6000 8160 8260 8360 Front Axle Drive Shaft	OE REF: 11068876
2	43528	Drive Shaft T6 T7 4WD Front Axle	OE REF: 84479002
3	43577	Keyway T7000 T7 T6000 Series Front Axle Drive Shaft	OE REF: 14723110
4	43527	Washer T6 T7 4WD Front Axle Drive Shaft	OE REF: 5198541
5	43574	Circlip M40 Internal TSA TM TL TD Front Axle Drive Shaft	OE REF: 11061976
6	43529	Bearing T6 T7 4WD Front Axle Drive Shaft	OE REF: 28996550
7	43526	Nut T6 T7 4WD Front Axle Drive Shaft	OE REF: 82037880
8	43519	Bearing T7 Front Axle Drive Shaft	OE REF: 84263341
9	43572	Axle Plate New Holland T7000 T7 Series T6000 Series Front Axle Drive Shaft	OE REF: 82037881
10	43575	Plug TSA TM T7000 T7 Front Axle Drive Shaft	OE REF: 83908579
11	43525	Bearing Carrier T6 T7 4WD Front Axle Drive Shaft	OE REF: 87601957
12	43522	Housing T6 T7 4WD Front Axle Drive Shaft	OE REF: 87618799
13	43524	Bearing T6 T7 4WD Front Axle Drive Shaft	OE REF: 28996540
14	43576	Circlip Internal T6000 T7000 TD T7 TM115 -TM165 TL Series Front Axle Drive Shaft	OE REF: 11061576
15	43523	Washer T6 T7 4WD Front Axle Drive Shaft	OE REF: 5150371

TM T6 T7 Series



43520
Drive Shaft New Holland T7 4WD Front
Axle [OE Ref: 84486152](#)

43579
Universal Joint New Holland **
Shaft is 43578 ** TM, T7, T6000
AND T7000 SERIES.
[OE Ref: 84355325](#)



43570
Universal Joint New Holland T7030
T7040 T7050 TM Series
[OE Ref: 82021088](#)



43583
Front Axle Shaft New Holland T6000 Series T7
Series T6.155 T6.165 T6.175 [OE Ref: 87747757](#)



Spindles & Steering Arms 2/ 3000 Series

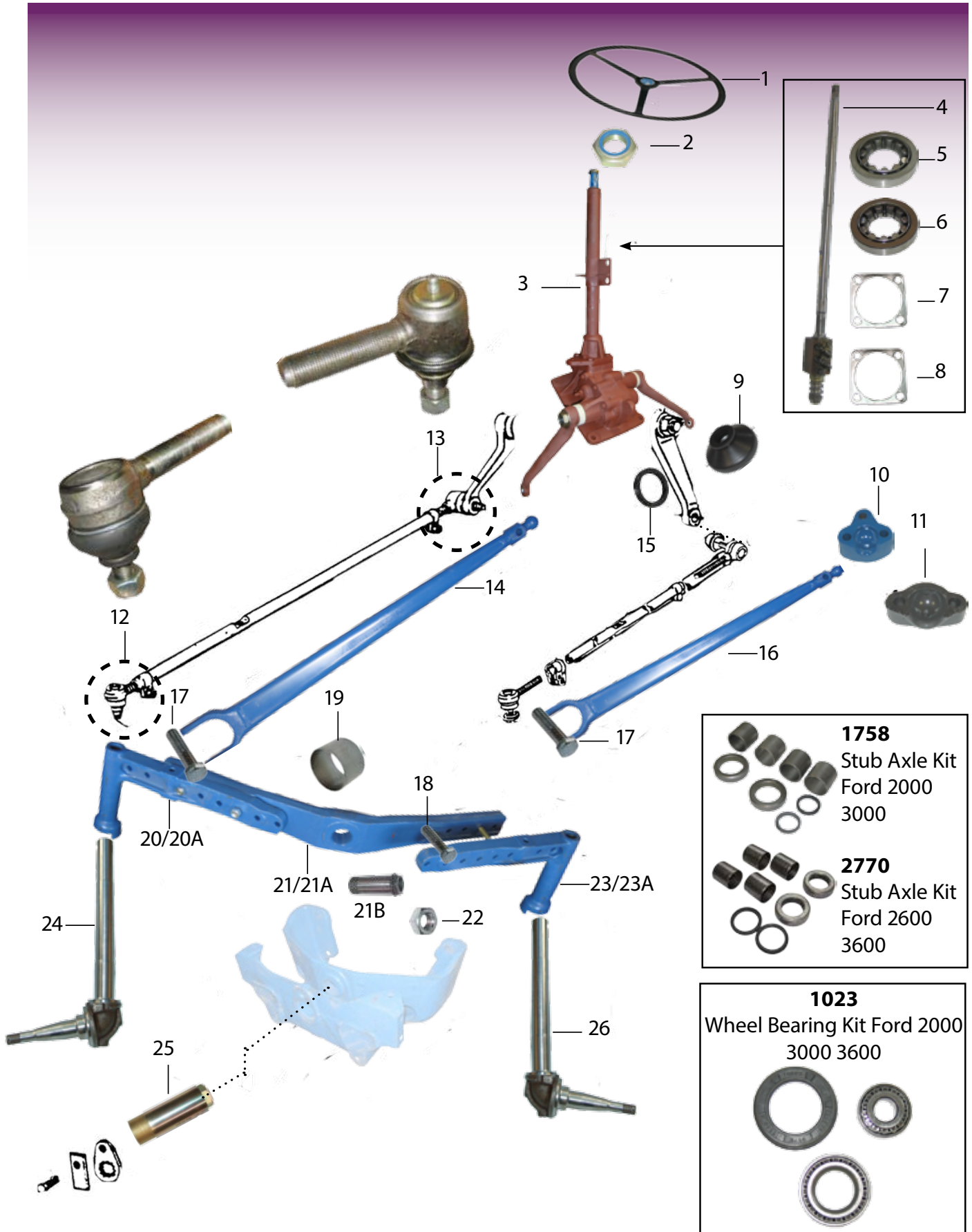

Spindles & Steering Arms 2/ 3000 Series

- | | | |
|------|----------------|--|
| 1. | 4948 | Steering Wheel Ford 2000 3000 5000 6600 + Cap |
| 2. | 4091 | Steering Wheel Nut Ford |
| 3. | 3293 | Steering Box Ford 3000 Manual |
| 4. | 4448 | Steering Worm Ford 3000 - 660mm |
| 5. | 1741 | Steering Box Bearing Ford 2000 3000 Upper 2"R |
| 6. | 4095 | Steering Box Bearing Ford 2000 3000 Lower 1 3/4" Ring |
| 7. | 42019 | Steering Column Shim Ford 2000 3000.15mm Between Steering box & Steering Hub |
| 8. | 42018 | Steering Column Shim Ford 2000 3000 0.25mm |
| 9. | 41391 | Track Rod End Boot Seal Ford - Small |
| 10. | 41380 | Radius Ball Lower Cap Ford 2000 - 3600 |
| 11. | 41381 | Radius Upper Cap Ford 2000 - 3600 |
| 12. | 4000 | Track Rod End Dexta 2000 3000 Front |
| 13. | 4001 | Track Rod End Dexta 2000 3000 Back |
| 14. | 41824 | Radius Bar Ford 2000 - 3600 RH |
| 15. | 1850519 | Steering Box Seal 165 WR969 Ford 5000 7000 165 168 175 178 185 188 265 275 285 290 65 |
| 16. | 41826 | Radius Bar Ford 2000 - 3600 LH |
| 17. | 353639 | Bolt 5/8" x 5" UNF Zinc & Yellow |
| 18. | 353627 | Bolt 5/8" x 3 1/2" UNF Zinc & Yellow |
| 19. | 1358 | Front Axle Pin Bush 2600 3600 2" 51mm |
| 20. | 41063 | Front Axle Support Ford 3000 3610 RH Fits 2310 2600 3600 3900 4000 SU 4100 |
| 20A. | 41064 | Front Axle Support Ford 3000 3610 LH Fits 2000 2310 2600 3000 3600 3900 |
| 21. | 409925 | Axle Beam Front Centre Ford 3000 3600 3610 (2" 51mm Centre Hole) |
| 21A. | 409924 | Axle Beam Front Centre Ford 2000 3000 (1 3/4" 44mm Centre Hole) |
| 21B. | 41026 | Front Axle Pin Ford 2000 3000 Early 1 3/4 44mm **Axle Beam 409924 ** |
| 22. | 353427 | Nut 5/8" UNF Zinc & Yellow To Suit Rim to Disc Stud |
| 23. | 41929 | Front Axle Support Ford 2000 3000 RH Old Type - No Hole
New Type with Hole is 41063 |
| 23A. | 41930 | Front Axle Support Ford 2000 3000 LH Old Type - No Hole
New Type with Hole is 41064 |
| 24. | 4016 | Spindle Ford 2000 3000 RH |
| 25. | 3930 | Front Axle Pin Ford 3000 3600 2" 51mm ** Axle Beam 409925 ** |
| 27. | 4015 | Spindle Ford 2000 3000 LH RH Side is 4016 |

Spindles & Steering Arms 4000/ 4600 Series

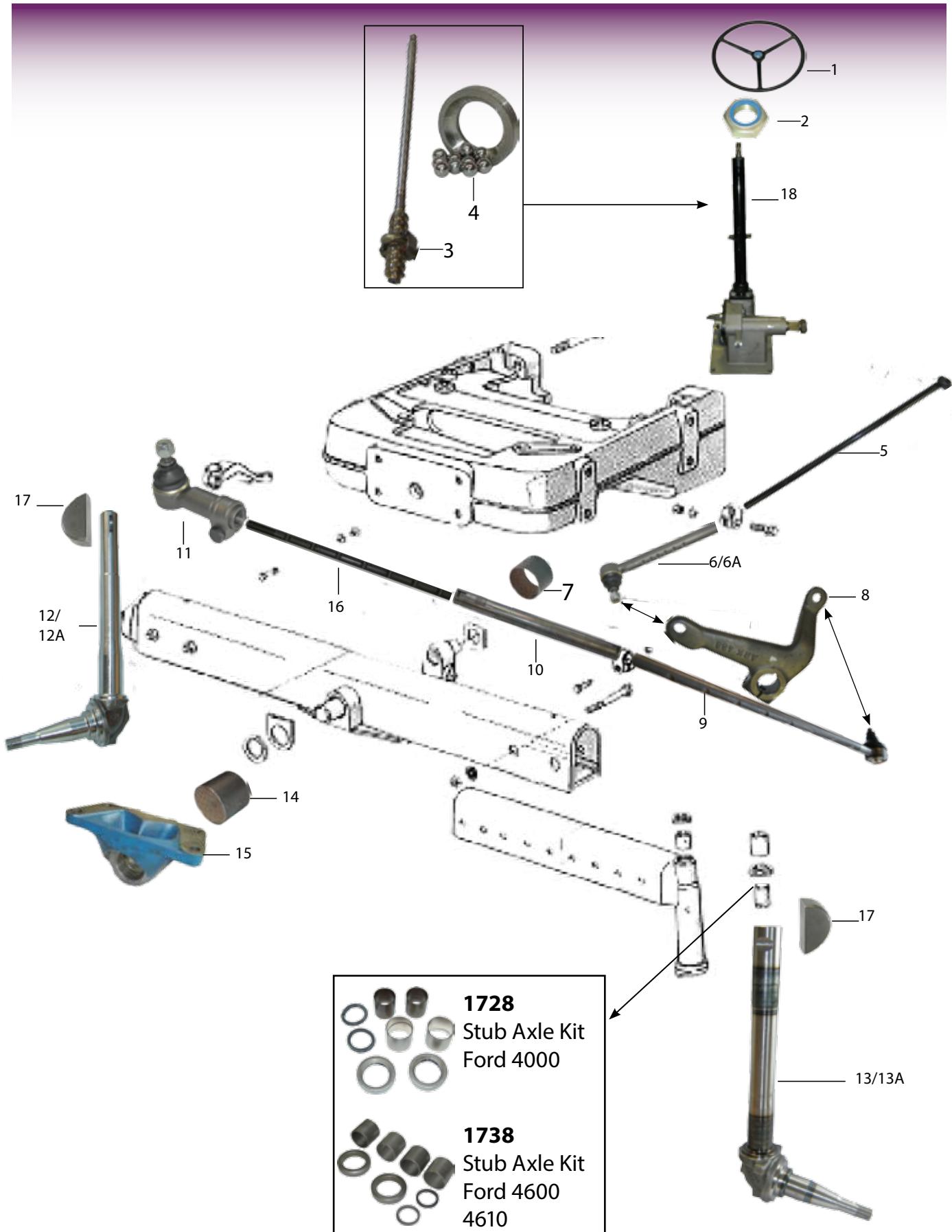

	1728 Stub Axle Kit Ford 4000
	1738 Stub Axle Kit Ford 4600 4610

Spindles & Steering Arms 4000/ 4600 Series

- | | | |
|------|--------------|---|
| 1. | 4948 | Steering Wheel Ford 2000 3000 5000 6600 + Cap |
| 2. | 4091 | Steering Wheel Nut Ford |
| 3. | 4453 | Steering Worm Ford 4000 4600 |
| 4. | 2932 | Steering Box Bearing Kit Ford 4000 4600 |
| 5. | 2217 | Drag Link 4000 4600 |
| 6. | 4004 | Track Rod End Ford 4000 4600 |
| 6A. | 1298 | Track Rod End Ford 4610 Front Push in |
| 7. | 2796 | Bush Ford 4610 Front Axle Rear |
| 8. | 42272 | Arm Stub Axle Ford 4600 4610 |
| 9. | 4003 | Track Rod End Ford 4000 4600 |
| 10. | 2442 | Track Rod End Ford 4000 Tube Suits Manual Steering
Suits Manual Steering Also fits Models 4100 4330 4340 |
| 11. | 4002 | Track Rod End Ford 4000 4600 Screw In |
| 12. | 4017 | Spindle Ford 4000 LH |
| 12A | 4020 | Spindle Ford 4600 4610 RH |
| 13. | 4017 | Spindle Ford 4000 LH |
| 13A. | 4019 | Spindle Ford 4600 4610 LH |
| 14. | 2797 | Bush Ford 4610 Front Axle Also fits 4000 4340 4100 4600 |
| 15. | 2379 | Front Axle Bracket Ford 4000 |
| 16. | 42170 | Track Rod End Threaded Bar 3430 3930 4130 4630 4830 5030 4000 4600 4610 |
| 17. | 1059 | Woodruff Key Ford 5000 7600 |
| 18. | 42891 | Steering Box Ford 4000 |

Ford Stub Axle Components

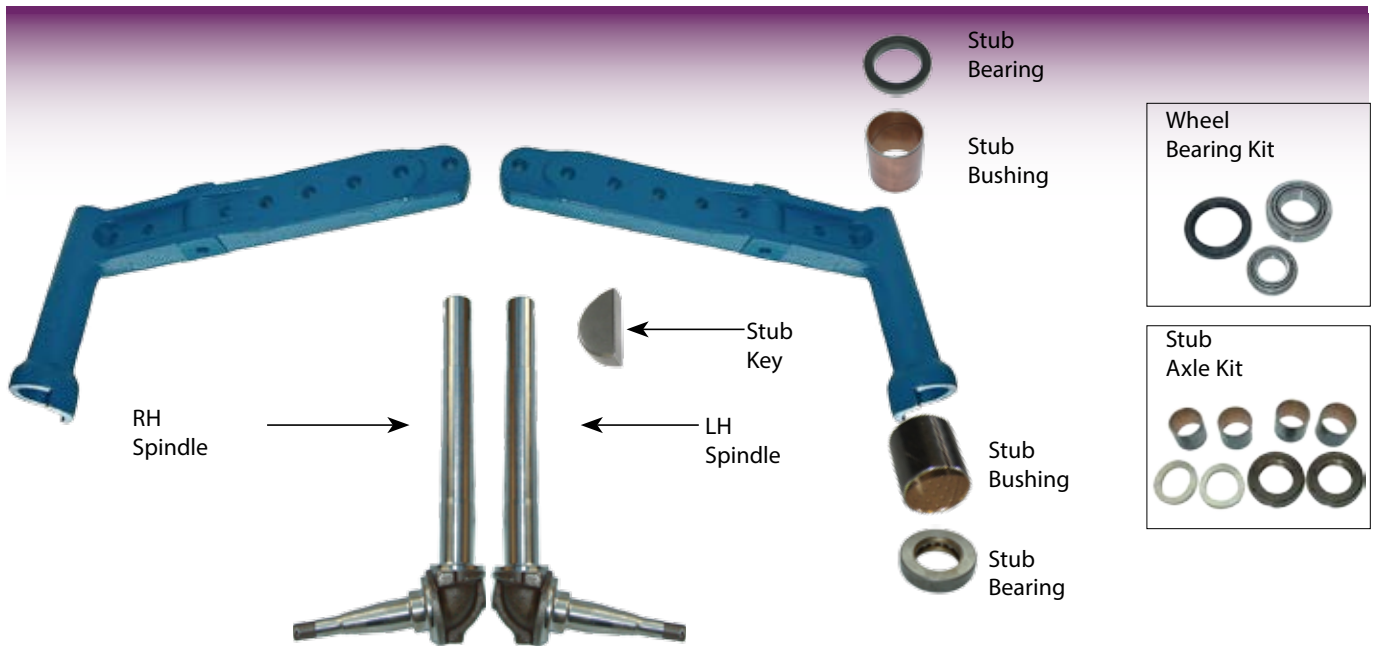

Model	RH Spindle	LH Spindle	Wheel Bearing Kit	Stub Axle Kit	Stub Bushing	Stub Bearing	Seal	Stub Key
Dexta	41237 (A= 271mm)	41238 (A= 271mm)	1023	1758	3301-Top 3302-Bottom	3303	3300 3305	5307
Major	41061	41062	2005	2768	3113-Top 3113-Bottom	3114	3112 or 41065	
2/3000	4016	4015	1023	1758	3301-Top 3302-Bottom	3303	3300 3305	5307
26/3600			1023	2770	3302-Top 3302-Bottom	3303	3304	
4000	4018	4017	1021	1728	3301-Top 3306-Bottom	3307	3305	5308
46/4610	4020	4019	1021	1738	3306-Top 3306-Bottom	3307	3308	1059
5-7600	4022	4021	1159	1469	3310-Top 3311-Bottom	3312	3309	1059
67/7610	4022	4021	1159	1469	3310-Top 3311-Bottom	3312	3309	1059
5640 -8340 TS	1249	1249	1159		41035-Top 41033-Bottom	3312		
550 Digger						1988		

Front Axle Parts

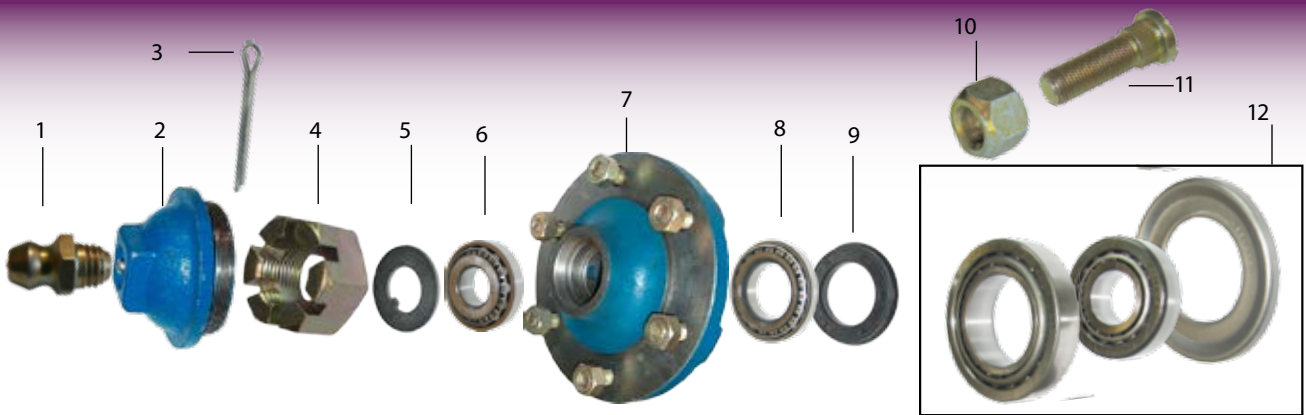

	Model	Dexta Super Dexta 2000 2600 3000 3600 3900 3910	Major Power Major Super Majr	4000 4100 4110 4600 4610 5030	4630 4635 5030 5635 6635 7635 TL60-110A TN55-75	5/5600 5610/40 5700 6410 66/10/40 6710 6810 7/7600/10 77/40 7810/40 7910 8210 TS80 - 115A
1	Grease Nipple	200191		200191		200191
2	Hub Cap	1884289 Cast 41614 Steel	41213	1884289 Cast 41614 Steel		4118 Cast 4408 Steel
3	Split Pin	2812		2812		2812
4	Spindle Nut	353928		353928		353928
5	Washer	180010		180010		180010
6	Outer Bearing	LM11949/10	14118/14283	LM11949/10	84548/10	LM12649/10
7	Hub	3428	41242 Stud=906863	3425		3421
8	Inner bearing	LM67048/10	352/355X	LM48548/10	LM501349/10	LM501349/10
9	Seal	957E1190A	41065	CONN1190B	5713	3477
10	Nut	4060		4060	4060	4060
11	Stud	4059	906863	4059	4059	4059
12	Wheel Bearing Kit	1023	2005	1021	1886	1159

P/S Conversion Kits



51070
Power Steering Kit Ford 2000
3000 3600



41318
Power Steering Kit Ford 4000 4600



42996
Extension Piece
For 41318

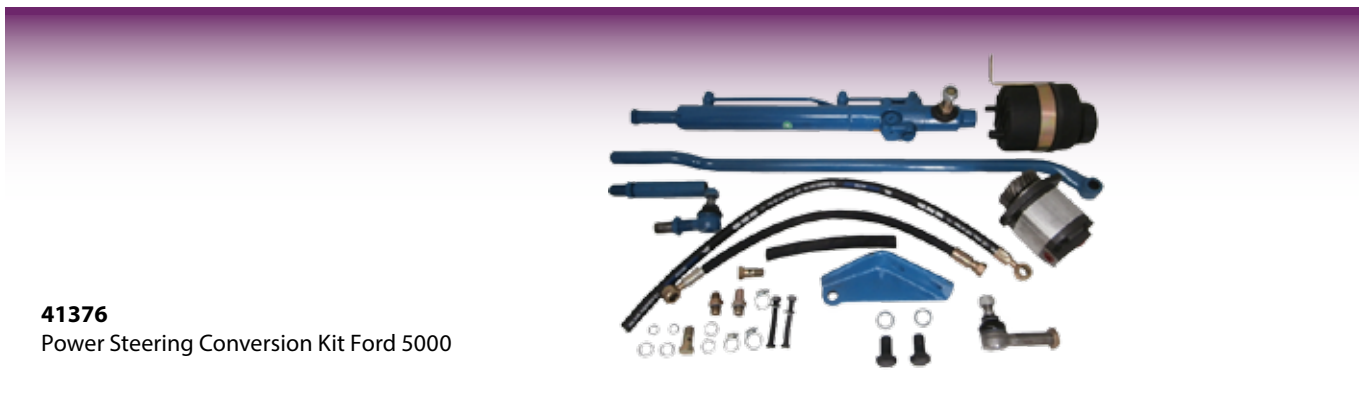

41376
Power Steering Conversion Kit Ford 5000

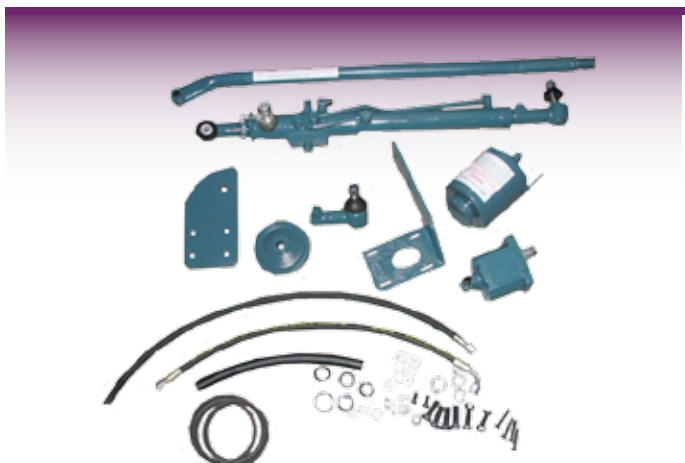

41733
Power Steering Kit Fordson Major

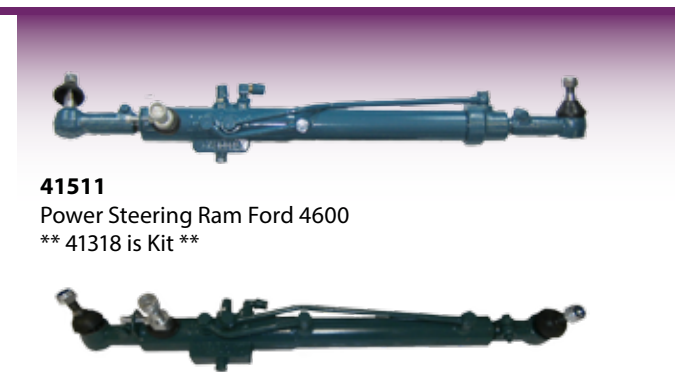

41511
Power Steering Ram Ford 4600
** 41318 is Kit **

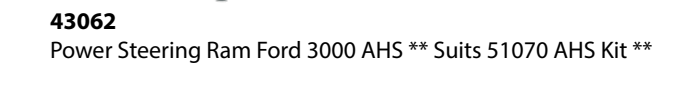

43062
Power Steering Ram Ford 3000 AHS ** Suits 51070 AHS Kit **

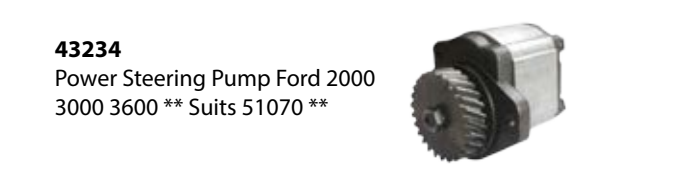

43234
Power Steering Pump Ford 2000
3000 3600 ** Suits 51070 **



41864
Track Rod End Ford 2000 4000 5000 (AHS only) Fits
PS kits 41376 41733 41318



41865
Track Rod End Ford 4000 5000 (AHS only) Fits
PS kit 41318

Vintage & 2/3/4000 Steering Parts





 <p>41244 Steering Shaft Fordson / Super Major 25 7/8"</p>	 <p>41509 Steering Worm Major 24 1/2"</p>	 <p>41245 Steering Shaft Nut Fordson Super Major</p>
--	--	--

 <p>41483 Rocker Shaft Major Ford 4000 4600 4610</p>	 <p>41543 Steering Seal Top Dexta / Super Dexta</p>	 <p>48844 Steering Shaft Worm Gear Thrust Bearing Fordson N's 2N/700/9N Thrust Bearing</p>
--	---	--

 <p>41450 Steering Box Seal Super Major 35 x 47 x 7mm</p>	 <p>2932 Major Steering Box Bearing</p>	 <p>51559 Chrome Steering Washer</p>
 <p>41527 Steering Shaft Nut Super Major</p>	 <p>41385 Steering Wheel Nut Dexta</p>	 <p>51558 Chrome Steering Washer TE 20</p>

 <p>4949 Steering Wheel Dexta 1 1/4" Fine Spline</p>	 <p>4950 Steering Wheel Major</p>	 <p>41772 Steering Repair Kit Dexta Standard **Not Super Dexta**</p>	 <p>41149 Seal Kit Ford 2/3/4000 Power Steering Ram</p>
---	---	---	---

Ford Steering

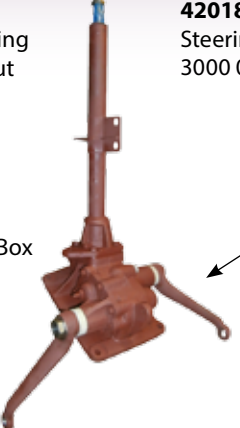
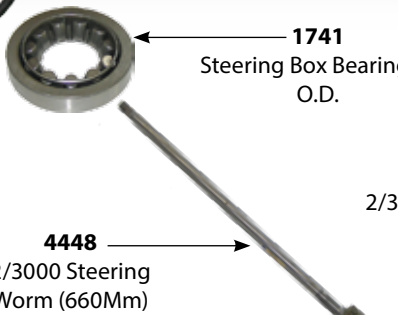
 <p>4948 2/3/5/66 Steering Wheel + Cap</p>	 <p>4091 Ford Steering Wheel Nut</p>	<p>42019 Steering Column Shim Ford 2000 3000 0.15Mm</p> <p>42018 Steering Column Shim Ford 2000 3000 0.25Mm</p>
 <p>1741 Steering Box Bearing 2" O.D.</p>	 <p>4095 2/3000 Lower Steering Box Bearing 1 3/4" O.D.</p>	 <p>3293 Steering Box Ford 3000 Manual</p>
 <p>4448 2/3000 Steering Worm (660Mm)</p>		

4/5/7600 Manual Steering Box Parts

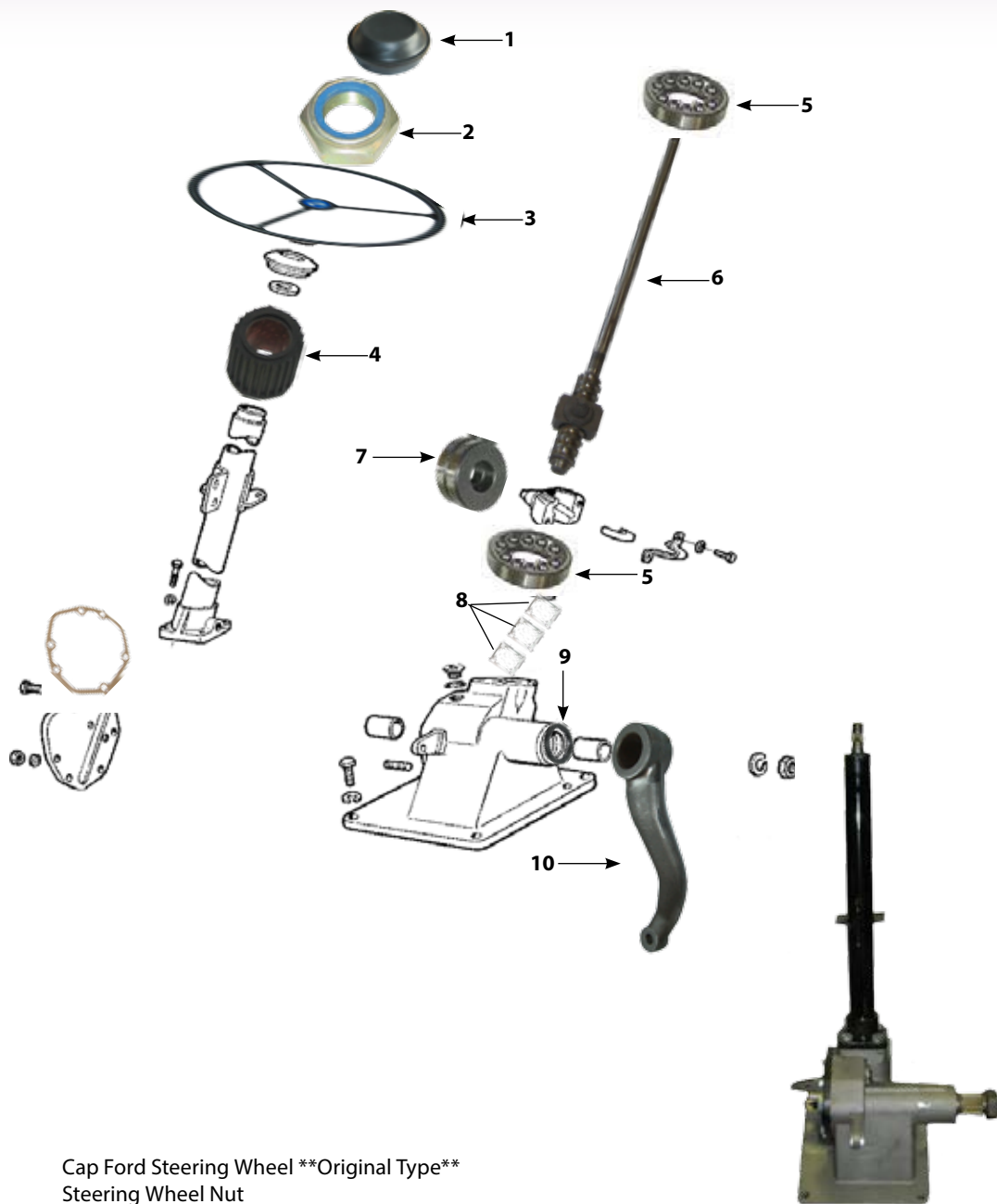

- | | | |
|-----|----------------|--|
| 1. | 4153 | Cap Ford Steering Wheel **Original Type** |
| 2. | 4091 | Steering Wheel Nut |
| 3. | 4948 | Steering Wheel |
| 4. | 1853210 | Steering Column Bush 165 |
| 5. | 2932 | 4000/4600 Steering Ball Bearing Race |
| 6. | 4449 | Steering Worm Ford 550 Digger |
| 6. | 4453 | 4/4600 Steering Worm(660Mm) |
| 6. | 4094 | Steering Worm Ford 5000 7000 6610 Manual |
| 7. | 4452 | Steering Shaft Main Nut Roller Ford 5000 6600 |
| 8. | 42019 | Steering Column Shim Ford 2000 3000.15mm Between Steering box & Steering Hub |
| 9. | 4097 | Steering Box Oil Seal Ford 5000 6600 7600 |
| 10. | 409828 | Steering Box Arm Ford 6600 7600 Power Steerin |

42891
Steering Box Ford 4000
Manual

5/7600 Manual Steering Box Parts



5/7600 Power Steering Box Parts

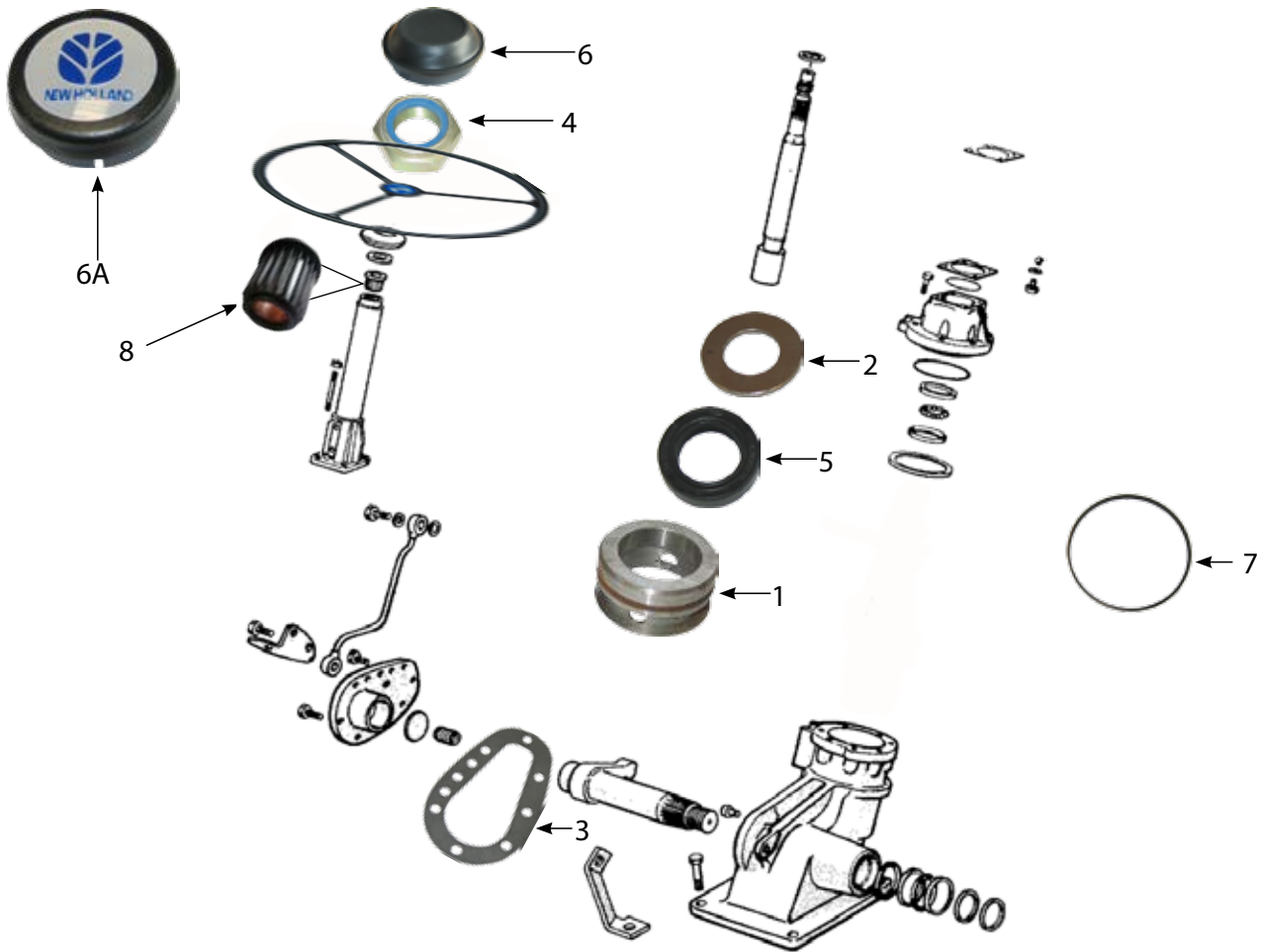

- | | | |
|----|--------------|---|
| 1. | 2371 | Steering Column Ring Ford |
| 2. | 2373 | Thrust Washer Ford |
| 3. | 4354 | Gasket Gear Box Ford 4600 - 7610 Power Steering ***Gasket has Steel Mixture** |
| 4. | 4091 | Steering Wheel Nut |
| 5. | 2369 | Seal Steering Column Ford 2310 - 7610 **4000 - 7000 & 4600 - 7600** |
| 6. | 4153 | Steering Wheel Cap |
| 6A | 42032 | Cap Ford TS Steering Wheel |
| 7. | 42216 | Pressure Ring Power Steering Box Ford 5000/66 |
| 8. | 43170 | Steering Bush Ford 10s 100s 1000s 30s 40s Industrial, ID 20.5mm OD 35mm Height 35mm |

5/7600 Power Steering Box Parts



42216
Pressure Ring Power Steering
Box Ford 5000/66



41139
Seal Kit Steering Box Ford Power Steering
Paper Gaskets no steel



1740
Power Steering O Ring Kit
Ford

Front Axle

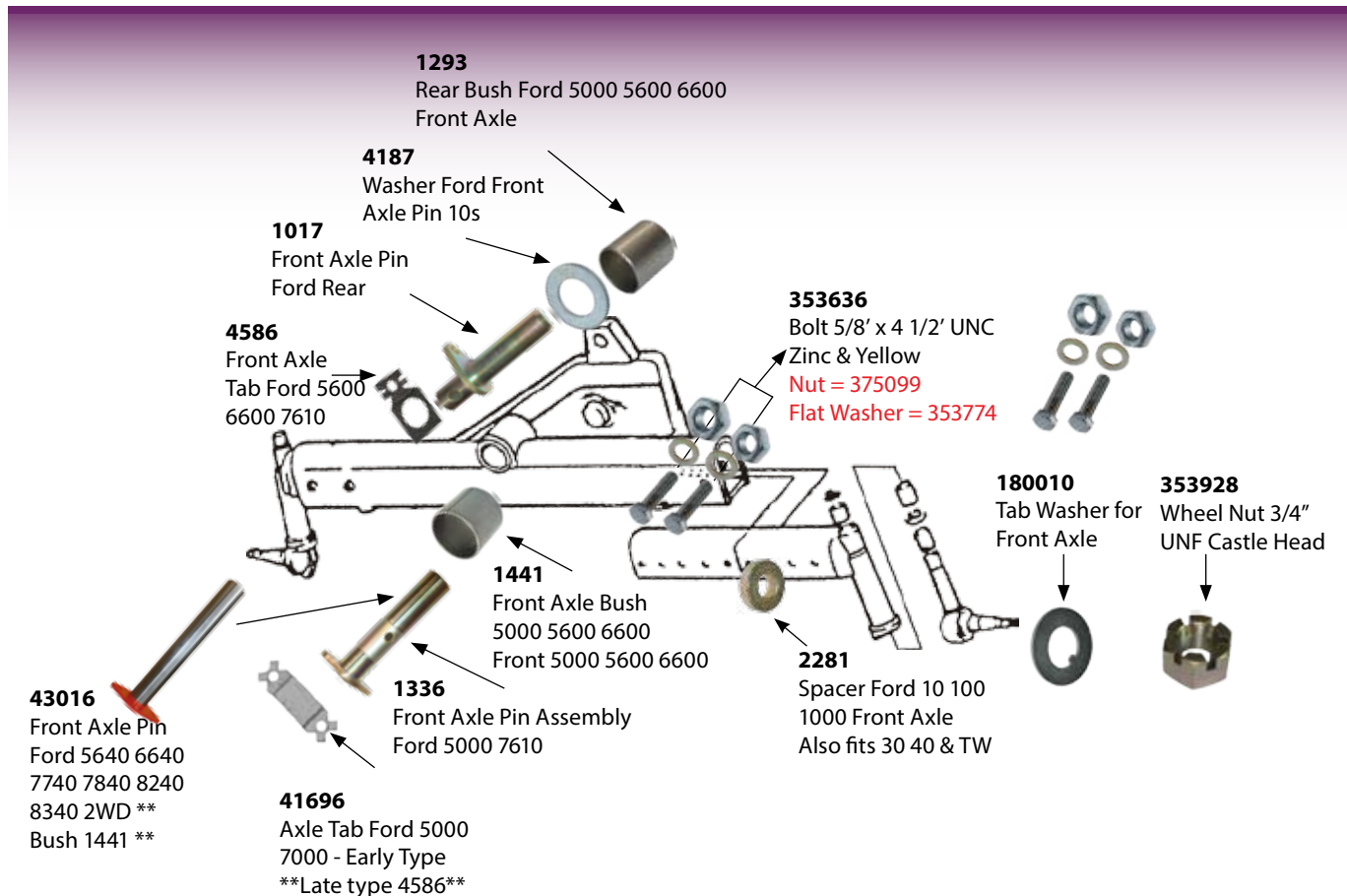
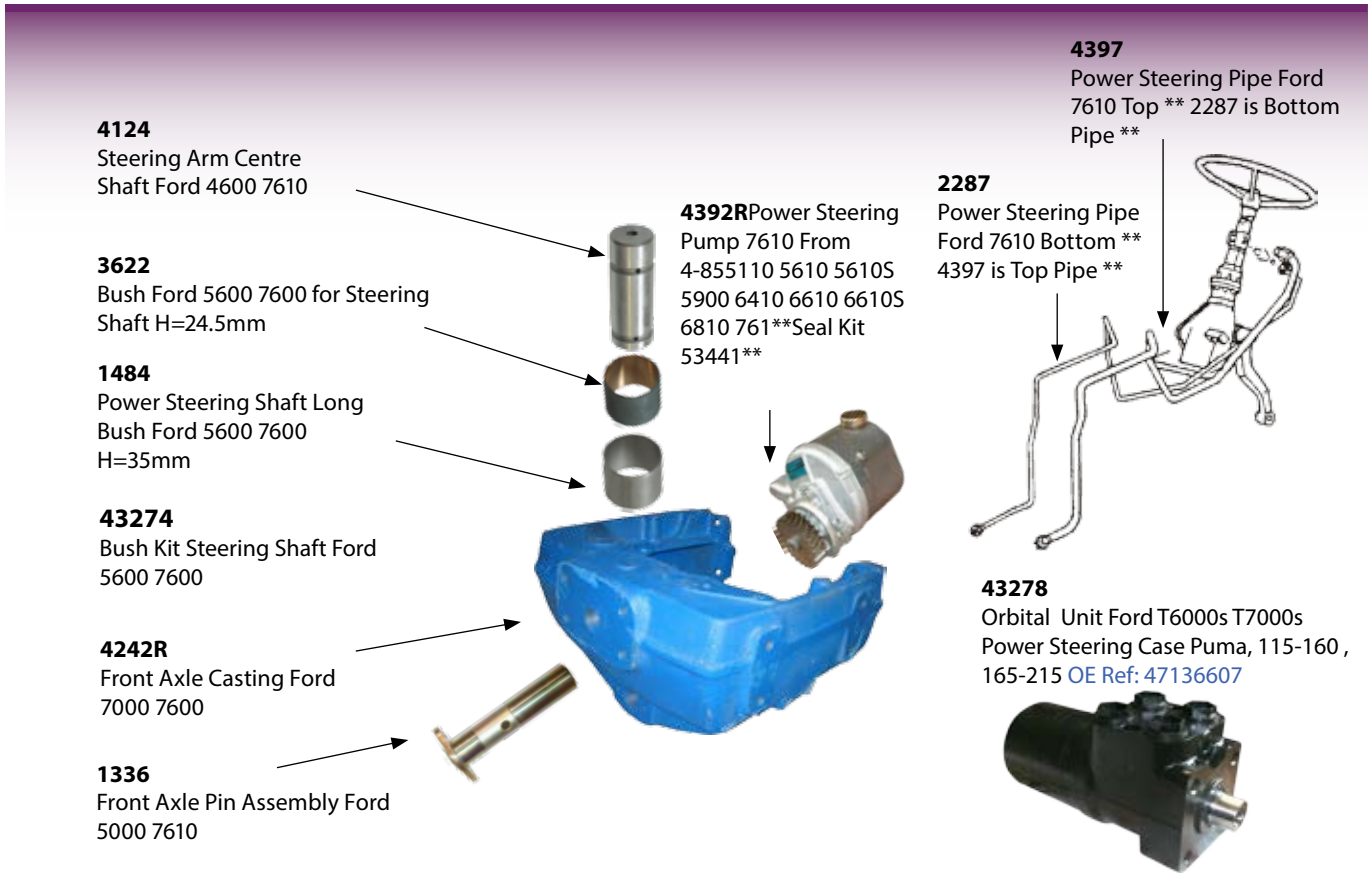

Front Axle Parts 5000/7600

Power Steering

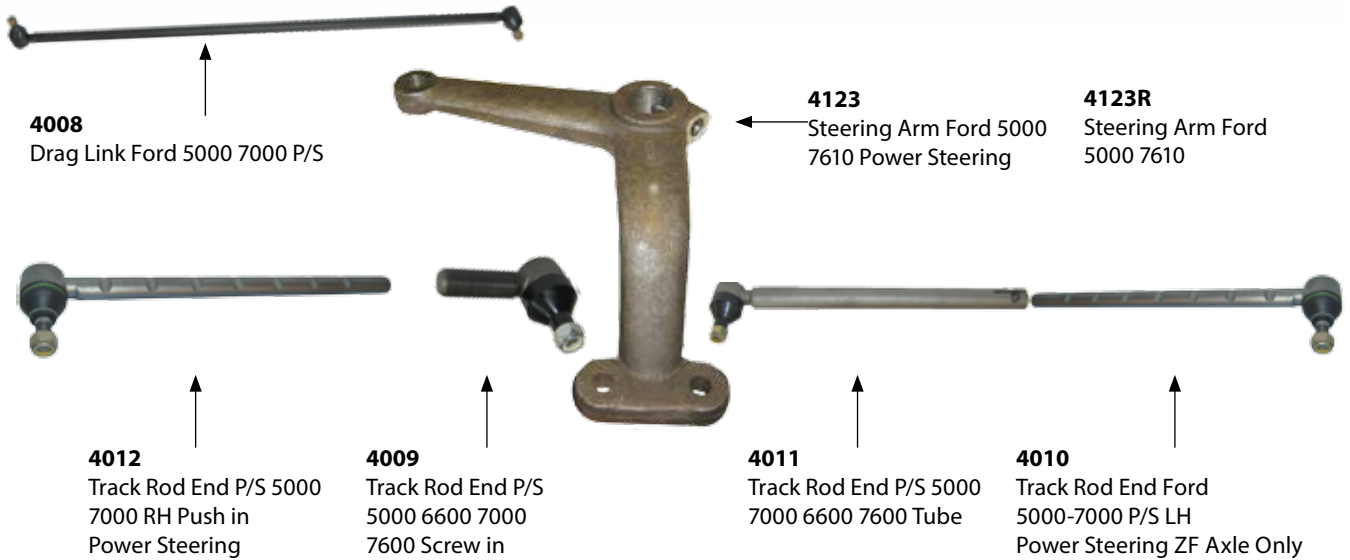

Manual

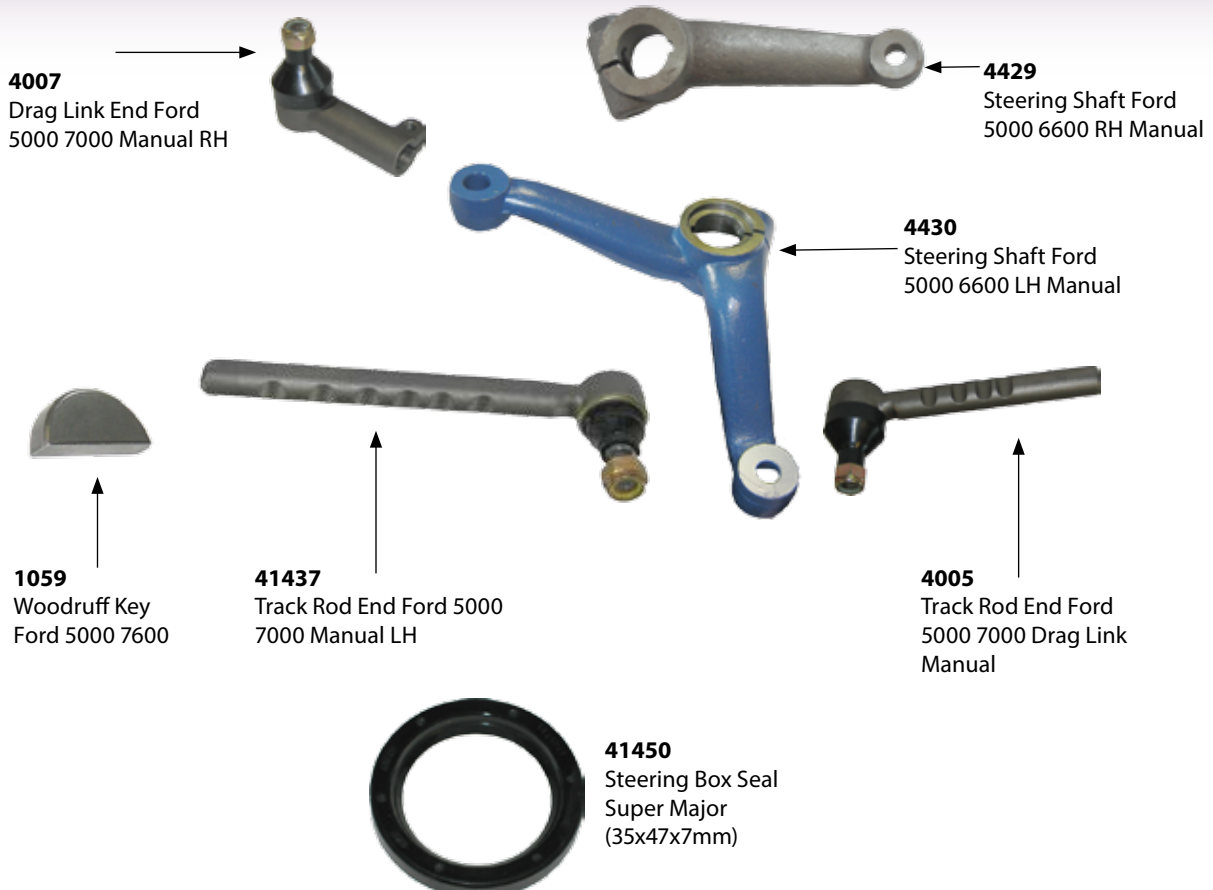

Steering Parts

Power Steering Pipes & Orbital Units

2410
Seal Ford 5610 6610 7610 Steering Motor



2412
Seal Ford 7710 8210 Orbital Unit



2406
Steering Motor Seal TW5 TW15 TW25 TW35

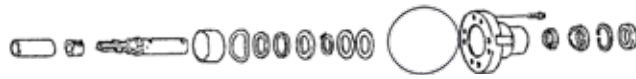

3558
5610/6610/7610 Orbital Unit "O" Ring

4605
Orbital Valve Ford 40 Series & Ts 4 W/D



41004
Orbital Unit Seal Kit Ford TW **
2406 is Steering Motor Seal **



4889
Steering Motor Seal Kit Ford 5610-8210



2288
Power Steering Pipe Ford 4600 Bottom Q Cab



2290
Power Steering Pipe Ford 5000 7600 Top Early Type

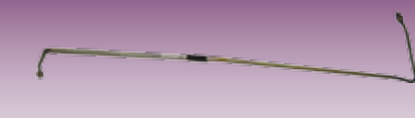

4126
Power Steering Pipe Ford 5000 6600 7600 - Bot Q Cab



2286
Power Steering Pipe Ford 4000 4600 Bottom



2289
Power Steering Pipe Ford 5000 Bottom



4127
Power Steering Pipe Ford 5000 7600 (Top) Late Type



4397
7610 Top P/S Pipe



2287
7610 Bottom P/S Pipe



Power Steering Pumps



4393
Power Steering Pump 7610
- Up to 3-85) ***With Relief
Valve*



1503
Power Steering Pump Ford
4000 4600 5000 5600 6600
7000 7600 7810 ** 1100 psi
*** ** 800 psi version is 41933
**



41933
Power Steering Pump Ford
2000 3000 2600 3600 **
800 psi version ** ** 1100
psi version is 1503 **



4221
Power Steering Pump Ford
TW5 TW15 TW20 TW25

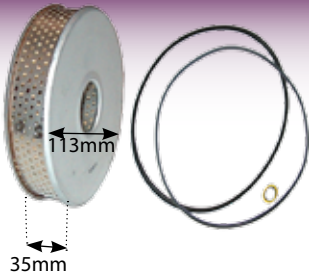

1669
Power Steering Pump Filter
Ford Massey Ferguson 699
David Brown



4392R
Power Steering Pump 7610
From 4-85 5110 5610 5610S
5900 6410 6610 6610S 6810
761
Seal Kit 53441

1243
Power Steering Pump Ford TW30
35



41563
Power Steering Pump Ford Digger
550 555 655



4125
Power Steering Pump 67
7710 7810 79 8210



4391
Power
Steering Pump
Ford County



1500
Oil Filler Cap
Ford Power
Steering



41521
Power Steering Pump Cover Ford
3000 5000

Power Steering Parts

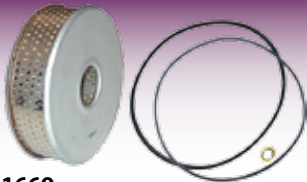

1669
P/S Filter
C/O Seal Kit



85251
Power Steering Reservoir
"O" Ring

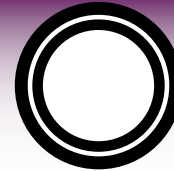

4092
Power Steering Pump Seal
Ford (WRA73) ** 1300 is Seal
Kit **

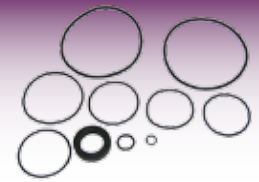

1712
Orbital Unit Seal Kit Ford

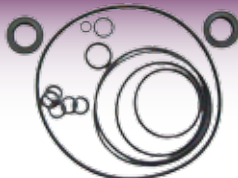

1300
Seal Kit Ford David Brown
Power Steering Pump
** 4092 is Pump Seal **

2335
Repair Kit Ford 6600 Power
Steering Ram 2W 7610 40 TS
Series 2WD



Orbital Units

1447

Orbital Unit 300 3000 - 100
OSP



100 OSP M18

6907

Orbital Unit 300 3000 125 OSP
M18 Thread



125 OSP M18

4655



Orbital Unit c/o Relief Valve
3/4 JIC 100 OS

100 OSP 3/4" JIC

4564

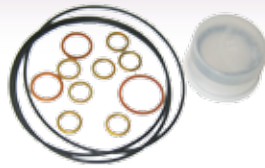

Orbital Unit Seal Kit to Suit
4655

4605



Orbital Unit Ford 40
TS 4WD
M18 -12 Spline
24.25mm Diameter
20mm high

150 OSP M18

43278

Orbital Unit Ford T6000s T7000s
Power Steering Case Puma, 115-
160, 165-215 OE Ref: 47136607



4857

Orbital Unit John Deere
160 OSP (40 Series)



175 OSP 1/2" JIC

43276 Orbital Unit Ford New
Holland T5030 T5040 T5050
T5060 T6010 T6020 T6030
T6040 T6050 T6060 T6070 Elite
TL100 TL70 TL80 TL90 TL100A
OE Ref: 47137781



52184

Orbital Unit Case MXU
Puma JX JXU Maxxum
Ford 35 60 TL L M T TL
Series TLA TM TSA TSA
Series STZ0R125M170



175 OSP M22

7808

Orbital Unit Fiat 56 88 90 93 94 Series
100 OSP 1/2" BSP



100 OSP 1/2" BSP

1504266



Orbital Unit Repair Kit
IHC/Massey Ferguson/DB

1810503



Orbital Unit
Repair Kit

4620

Orbital Unit Fiat 2 Ram Axle 160 OSP
1/2bsp
Also fits Zetor



160 OSP 1/2BSP

4600



Steering Column Assembly Hydrostatic 830mm

62292

Orbital Unit Fitting Kit
675 -698 French Type



Weights & Mudguards All Mudguard Flaps Sold As Pairs

Tractor Mudguard Flaps Sold as Pairs

Note: All measurements are +/- 15mm due to the nature of manufacturing process

2436	2WD	A: 320 mm, B: 960mm
2969		A: 350 mm, B: 1000mm
402947		A: 380 mm, B: 1140mm
2968		A: 400 mm, B: 1225mm
402948		A: 480 mm, B: 1160mm
2959		A: 540mm, B: 1320mm
2960		A: 600mm, B: 1340mm



62811



Mudguard Kit Universal
4WD 400mm Flaps **
63136 is Adaptor Plate **

63136



Conversion Plate Mudguard
Mounting Bracket ZF Side
Drive Case MF Carraro 709
** Suits 62811 Mounting
Bracket Kit **

62749



Mudguard Mounting
Bracket 398 Pair

2993

Mudguard Kit Front 3060/3070 350mm 2WD



51719



Mudguard Spacer
40mm

1488



Mudguard Trailer
Tandem 8" x 68" -
PAIR

1496

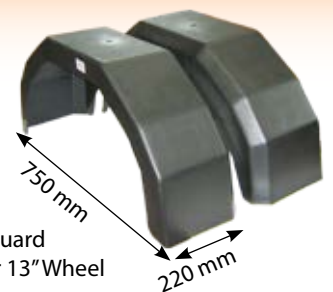

Mudguard
Trailer 13" Wheel
- PAIR

4555
Weight Extension
New Holland



Cab, Sheet Metal & Electrical

Date:..... No. of Pages:.....

Name of the Rep..... A/C Number:.....

From:..... e-mail.....

Phone No.:..... Fax No.:.....

Please quote for the following parts - Quotation Number :

I wish to confirm the following order on Quotation Number:

Please supply the following parts:

Qty	Part No.	Description	Unit Price
1.			
2.			
3.			
4.			
5.			
6.			
7.			
8.			
9.			
10.			
11.			
12.			
13.			
14.			
15.			
16.			
17.			
18.			
19.			
20.			
21.			
22.			
23.			
24.			

Please photocopy this page

Please do not remove this page

Comments:

Customer Signature:

Rep's Signature:

Tel No: + 353 44 934 1638

e-mail: info@qtponline.com, www.qtponline.com

Page of

Front Wheel Studs & Nuts

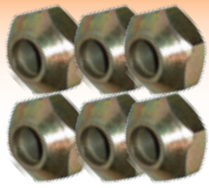

4060
Wheel Nut Ford Front 1/2 UNF

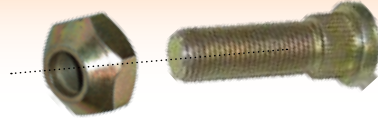

195490
Wheel Nut 135 165 Front (1/2" UNF)

4059
Front Wheel Stud (All Models)

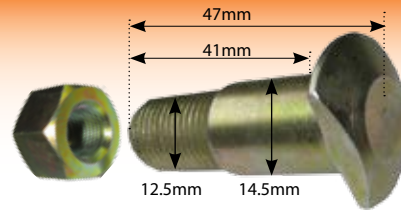

41830
Wheel Stud Dexta Front 1.5" UNF **
Nut is 62986 **
Nut = 42234

Rear Wheel Studs & Nuts



881162
Wheel Nut 165
Wheel Nut 165
Rear Wide 5/8" UNF

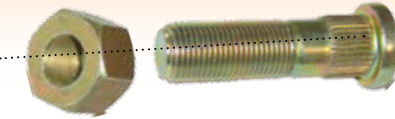

184273
Wheel Nut 165 168 Dexta Rear Narrow 5/8 UNF

4152
Wheel Stud Ford 2000 3000 3600 Rear 5/8 UNF x 2 1/4

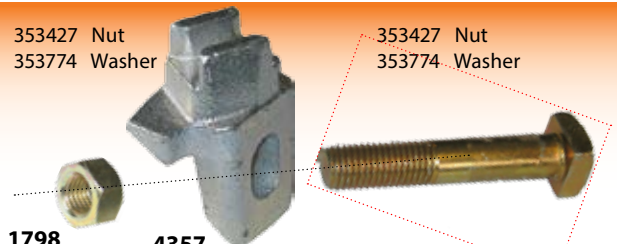

1798
Wheel Clamp Nut Ford TW 3/4 UNC

4357
Wheel Wedge Ford TW Fiat & New Holland

1784
Wheel Stud Ford TW Clamp

409750
Wheel Nut Ford 40 M TS Rear 3/4" UNF 8 per Hub



1404
Wheel Nut Ford 4000 7000 Rear 3/4" UNF



43099
Wheel Nut M18 1.5 Pitch Ford TM120 Rear



1404A
Wheel Stud Ford 2000 7000 Rear



43109
Wheel Bolt Ford TM Rear M18 x 1.5 x 65mm



43012
Rear Wheel Stud Dexta



1054
Wheel Extension Stud 165 Ford 3000 5/8" Nut 881162



1186
Wheel Stud Rear Ford 10 Series 3/4 UNF x 2 5/16



1055
Wheel Extension Stud Rear 35 135 9/16"



1465
Wheel Extension Stud Front 1/2" Front



Rim to Disc Bolts



1671
Rim to Disc Bolt Sankey c/o Nut & Washer M16 x 125mm Square Shoulder

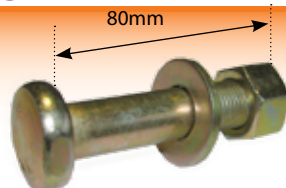

828217
Rim To Disc Bolt & Nut +Washer 5/8" UNF x 2 7/8"

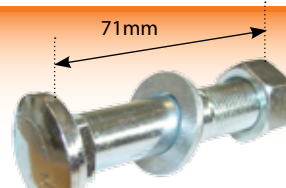

1330
Rim to Disc Bolt Ford c/o Nut & Washer (5/8 UNF x 71mm long) Square Shoulder







353427 Nut
353774 Washer



51330
Disc to Rim Wheel Lug

Wheel Rims & Tyres

Front Wheel Rims

Part No	Description	Size	OE Ref:	Photo
1730	Wheel Rim 6 Hole Rim	600 X 16	885741M3	
1729	Wheel Rim	750 X 16 Rim Front		
4474	Wheel Rim	900 & 1000 X 16 Front	1676159M94	
1399	Wheel Rim	750 X 18" Tyre	1861319M91	
61575	Wheel Rim Front for TE 20 TED 20	400 X 19	C5NN1015A	
1270	Wheel Rim 4WD Front - 8 Stud 8.5" Centre Hole	10 X 24	1687948M91	

Tyres & Tubes

51831



Tyre & Tube 400 x 19 TE 20

53083



Tyre & Tube 600 x 19

52859



Tyre Repair Kit Tubeless

53207



Paint Spray Can Silver Wheel Spray 500ml

53208



Paint Spray Can Grey Primer Wheel Spray 500ml

53209



Paint Spray Can Black High Gloss Wheel Spray 400ml

53210



Paint Spray Can Matt Black Wheel Spray 500ml

Wheel Rims & Tyres

Rear Wheel Rims

Part No	Description	Size	OE Ref:	Photo
61222	Wheel Rim Complete	9 X 28 For 11 X 28 Rear For 11 X 28 Tyre	005215U1	
61130	Wheel Rim	9 X 28 for 11 X 28 Tyre		
61131	Wheel Rim	11 X 28 for 12 X 28 Tyre		
61897	Wheel Rim 2" Lug Band Only	11 X 32		
61464	Rear Wheel Rim (2" Lug)	11 X 36	1863773M91	
4538	Complete Rear Wheel Rim	11 X 28 For 12 X 28 Tyre	005215U1	

Tyres & Rims

2544



Wheel Rim Complete 600 X 16 c/w Tyre

2543



Wheel Rim Complete 750 X 16 c/w Tyre

2764



Wheel Rim Complete 11 x 28 c/w Tyre RH

2765



Wheel Rim Complete 11 x 28 c/w Tyre LH

53103



Wheel Rim Complete c/w Tyre 145 X 10 Suits 51135 & 51828

Power Adjustable Variable Track (PAVT) Parts

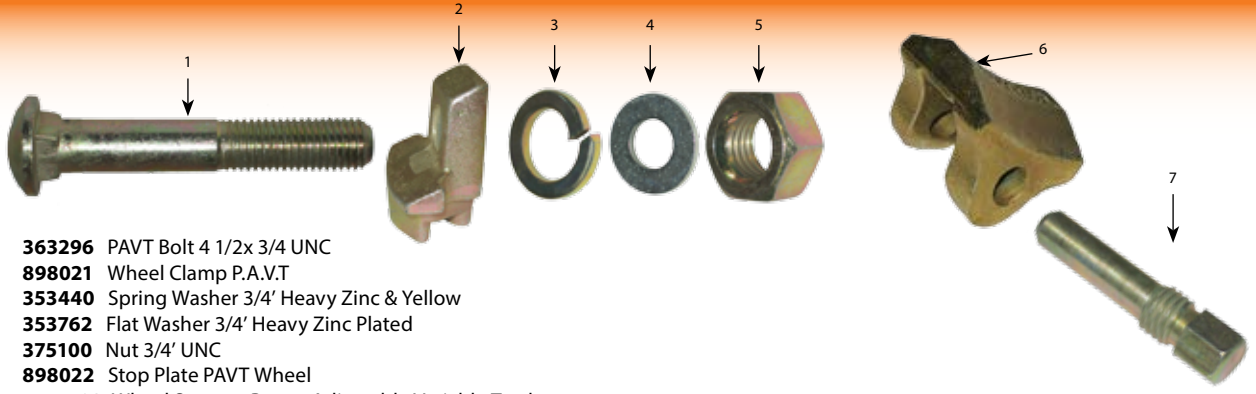

1. **363296** PAVT Bolt 4 1/2x 3/4 UNC
2. **898021** Wheel Clamp P.A.V.T
3. **353440** Spring Washer 3/4' Heavy Zinc & Yellow
4. **353762** Flat Washer 3/4' Heavy Zinc Plated
5. **375100** Nut 3/4' UNC
6. **898022** Stop Plate PAVT Wheel
7. **1751403** Wheel Stopper Power Adjustable Variable Track

Sticker Kits

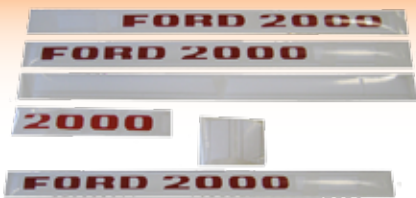

42131
Decal Kit Ford 2000



1778
Decal Kit Ford 2000 Pre Force



42217
Decal Kit Force Ford 2000



42266
Decal Kit Ford 2600



41588
Decal Ford 4000 5000 Roof



41811
Decal Fordson Yellow and Silver



1722
Decal Kit Ford 4000



1780
Decal Kit Ford 3000



41810
Decal Draft Control for Lift and Lower

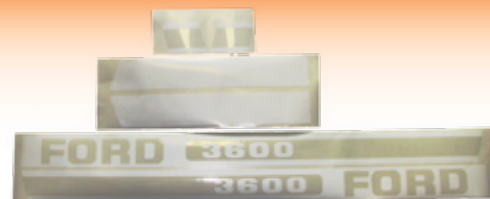

41626
Decal Kit Ford 3600



1751
Decal Kit Ford 4600



1530
4610 Force 2 Sticker (Red & Black)

Sticker Kits



1724
Decal Kit Ford 5000



7163
Badge Fiat 110-90
Front Grill Blue



43530
Emblem Ford TS100 - TS115
TM120 - TM175 64mm x
65.7mm
OE Ref: 82005611



4471
Decal Ford 5610 Force 2 Red &
Black



1727
Decal Kit Ford 6600



3952
Decal Kit Ford 6610 - With Cab



4718
Decal Ford 6610 Force 2 Red & Black



41564
Decal Ford Mark III - PAIR



41505
Decal Ford 2000 - 6600's Gear Change Chart
Gear Change Chart 2 Speed



41565
Decal Ford Mark II - PAIR



41504
Decal Ford 2000 - 6600's Gear Change Chart
Gear Change Chart Single Speed

Sticker Kits



1726
Decal Kit Ford 7000



1747
Decal Kit Ford 7600



4483
Decal Ford 7610 Force 2 Red & Black



4491
Decal Ford 7710 Force 2 Red & Black



3961
Decal Kit Ford 7610 - With Cab



41002
Decal Kit Ford 7810 Red & Black



4719
Decal Ford 8210 Force 2 Red & Black



4720
Decal Kit Ford 8210



41699
Decal Kit Ford 7840 - Up To 96



41700
Decal Kit Ford 8240 - Up To 96



41701
Decal Kit Ford 8340 (up to 96)



41702
Decal Kit Ford NH 7840 (from 97)



41703
Decal Kit Ford NH 8240 (from 97)



41704
Decal Kit Ford NH 8340 (from 97)



42023
Decal Kit New Holland 7740 **From 1997 Up**



41818
Decal Ford TW15 Super Q Cab Black & White x 2



41817
Decal Ford TW15 Q Cab Blue & White x 2



41820
Decal Ford TW25 Super Q Cab Black & White x 2



41819
Decal Ford TW25 Q Cab Blue & White x 2



41815
Decal Ford 7710 Super Q Cab Black & White x 2



41814
Decal Ford 7710 Q Cab Blue & White x 2



41816
Decal Ford 7910 Super Q Cab Black & White x 2

Sticker Kits



41973
Decal New Holland TM120
- Set Early Type Blac



42005
Decal New Holland TM120
Set Late Type White



41974
Decal New Holland TM130
- Set Early Type Blac



42006
Decal New Holland TM130
Set Late Type White



41975
Decal New Holland TM140 - Set
Early Type Blac



42007
Decal New Holland TM140
Set Late Type White



41976
Decal New Holland TM155 - Set
Early Type Blac

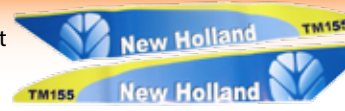

42008
Decal New Holland TM155
Set Late Type White



41977
Decal New Holland TM175 - Set
Early Type Blac



42009
Decal New Holland TM175
Set Late Type White



42010
Decal New Holland
TM190 Set Late Type
White

New Holland Decal Sets



41979
Decal New Holland
TS80 - Set



41980
Decal New Holland
TS90 - Set



41981
Decal New Holland TS100
- Set



41982
Decal New Holland
TS110 - Set



41983
Decal New Holland TS115 - Set



41984
Decal New Holland TM115 - Set
Old Type



41985
Decal New Holland TM125 - Set
Old Type



41986
Decal New Holland TM135 - Set
Old Type



41987
Decal New Holland TM150 - Set
Old Type



41988
Decal New Holland TM165 - Set
Old Type



42023
Decal Kit 7740



42001
Decal Bonnet New Holland
T6080 LH

New Holland Bonnet Decals kits

43333 FORD 8160 Left Hand + Right Hand
OE Ref: 82007993 + 82007994



42228 FORD 8160 Left Hand + Right Hand
OE Ref: 82007995 + 82007996



43335 FORD 8360 Left Hand + Right Hand
OE Ref: 82007997 + 82007998



43334 FORD 8560 Left Hand + Right Hand
OE Ref: 82007999 + 82008000



Kmph Decals

53680
Decal
30kmph



53681
Decal
40kmph



53682
Decal
50kmph



53683
Decal
60kmph



Emblems, Sticker Kits & Medallions



41955
Decal Kit Ford Metal
Writing Upper Grill



41542
Decal Kit Dexta



41273
Badge Super Major Side



41249
Badge Major Front - Wheat
Sheaf



41879
Badge Fordson Dexta Side

41961
Tractor Badge Major
Gear Shift - Live PTO



41971
Tractor Badge
Fordson Major
Commission Plate



41972
Tractor Badge Fordson Major - ID
Badge

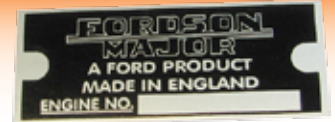

41248
Badge Super Major Front

48806
Badge Set
Fordson 2N
& 9N



41537
Badge Fordson
Dexta Front -
Chromed



41273
Badge Super Major Side

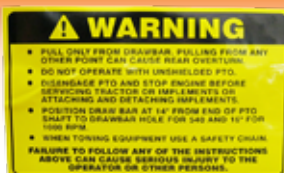

42096
Warning Decal
TW10 TW20 TW30



42097
PTO Decal Ford 10

Ford Seats

Dexta



41328
Seat Cushion & Back Rest Kit for Dexta

41328F
Seat Cushion & Back Rest Kit for Dexta

Major



41329
Seat Cushion & Back Rest Kit for Major **Has hump in cushion**

41329F
Seat Cushion & Back Rest Kit for Major **This is Flat**



48824
Seat Ford N's - 6 Holes NAA 2000 8N 800 900 **
48825 is Seat Spring *



43179
Seat Fordson Major



48825
Seat Spring Fordson N's NAA/2000/8N/800



41628
Seat Bracket Fordson Dexta



41602
Seat Pan Ford Super Dexta



41570
Seat Pan Fordson Major - 22 Hole



41566
Seat Ford 2000 - 7000
Seat Pan 41621 4100 5100



41621
Seat Pan Ford 2000 - 7000
Seat is 41566 4100 5100



41904
Seat Cushion Ford c/w Logo Red



41903
Seat Cushion Ford c/w Logo Blue



51738
Seat Black c/o
Seat c/o Angle Adjustment Black



51805
Seat Blue c/w Sliding Base



2195
Arm Rest Grammer Seat RH Landini John Deere



51737
Seat Black c/w Sliding Base



51606
Blue Seat Blue c/w Height Adjustment 4mm Base and support

4mm

4mm

SEARS SEATING

53764

**MECHANICAL SEAT
WITH COMPACT BASE**



Double depth Fabriform® comfort cushions

Weight adjustment 30-130kg

Height adjustment 80mm

Slide travel 160mm

Moulded suspension cover

Vibration performance to ISO 7096

Armrests with tilt up adjustment

Operator presence switch

Supplied with multifix mounting kit

908, Sears seat part No.
SA20459.400

53765

**AIR SEAT
WITH COMPACT BASE**



Double depth Fabriform® comfort cushions

Weight adjustment 30-130kg

Height adjustment 80mm

Slide travel 160mm

Moulded suspension cover

Vibration performance to ISO 7096

Armrests with tilt up adjustment

Operator presence switch

Supplied with multifix mounting kit

930, Sears seat part No.
SA20442.400

53766

**AIR SEAT
WITH SWIVEL**



Replaceable double depth Fabriform® comfort cushions

Height adjustment 76mm

Back angle fully adjustable

Automatic height & weight adjustment 50 -150kg

Automatic ride protection system (ARPS™)

Suspension stroke 80mm

Horizontal isolator fully integrated, sprung & Duo® Damped

Armrests with height & tilt up adjustment

Slide travel 160mm

Moulded suspension cover

Vibration performance to ISO 7096

Supplied with multifix mounting kit

3045, Sears seat part No.
SA24117.400

53928
Operator Presence Switch Service Kit - Suits 53766

53767

DELUXE AIR SEAT



Back recline adjustment

Fabric cushions (pour in place)

Integrated backrest extension

Lumbar - electric

Seat cushion length adj

Seat cushion angle adj

Low Frequency Pneumatic (12v)

ARPS (auto ride position system)

Fixed shock absorber

Integrated fore/ aft isolator

Armrests - tilt up, angle + height adj

Swivel 24 deg

Dlx fore/ aft slides 200mm travel

Operator presence switch

Document holder

Supplied with multifix mounting kit

Seat cushion width 560mm

Width across armrests 645mm

Seat Index Point SIP ---

Weight Adjustment

Height Adjustment

D5565A, Sears seat part No.
SA30582.400

53883

Compressor Service Kit 12V
Suits 53765 53766 53767



53884

Air Spring Service Kit Suits
53765 53766 53767



Date:.....

No. of Pages:.....

Name of the Rep.....

A/C Number:.....

From:.....

e-mail.....

Phone No.:.....

Fax No.:.....

Please quote for the following parts - Quotation Number :

I wish to confirm the following order on Quotation Number:

Please supply the following parts:

Please photocopy this page

Please do not remove this page

	Qty	Part No.	Description	Unit Price
1.				
2.				
3.				
4.				
5.				
6.				
7.				
8.				
9.				
10.				
11.				
12.				
13.				
14.				
15.				
16.				
17.				
18.				
19.				
20.				
21.				
22.				
23.				
24.				

Comments:

Customer Signature:

Rep's Signature:

Tel No: + 353 44 934 1638

e-mail: info@qtponline.com, www.qtponline.com

Page of

Fordson N Series Sheet Metal

48820
Air Cleaner Door Fordson
2N 8N 9N



48808
Fordson N's
Radiator Cap
2N/8N/9N
(1943-1952)

48818
Panel Fordson 2N/8N/9N RH



48822
Grill Fordson
8N/9N Front



48819
Panel Fordson 2N/8N/9N LH



48821
Air Funnel Assembly Fordson
8N



41779
Mudguard Skin Ford c/o Ford Logo



41795
Mudguard Ford c/o Logo and Original
Bracket **2N 8N 9N**

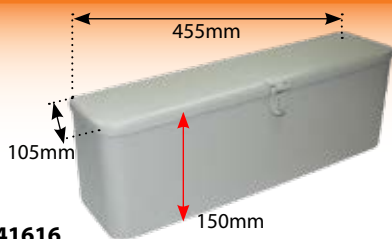

41616
Tool Box Major w/o
Bracket

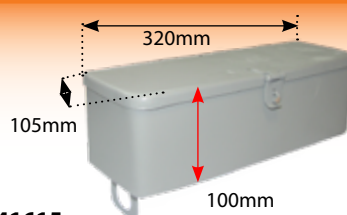

41615
Tool Box Dexta c/w Bracket
With Mounting Bracket



41915
Dynamo Guard Fordson
Major

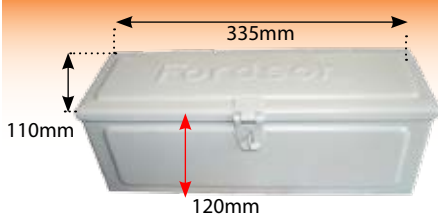

41794
Tool Box Fordson c/o Logo Model
N + F

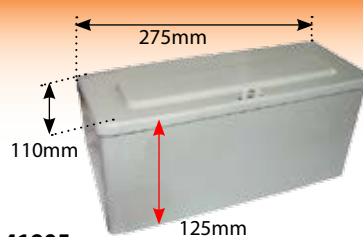

41905
Tool Box Fordson 8N

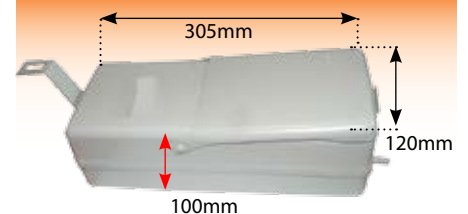

52726
Tool Box Fordson 9N

Fordson Major Sheet Metal

 <p>41215 Bonnet Fordson Major</p> <p>41214 Nose Cone Fordson Major</p>	 <p>41304 Bonnet Handle Super Major</p> <p>41643 Bonnet Panel Lock Ford LH RH Side 41369</p>	 <p>41388 Bonnet Handle Fordson Major Dexta Super Major</p> 	 <p>41946 Rubber for Bonnet Handle Fordson Major</p> <p>41369 Bonnet Panel Lock Ford LH Side 41643</p>	
 <p>41215NH Bonnet Fordson Major - No Air Breather Hole</p>	 <p>41271 Grill Fordson Major w/o Holes - PAIR No Holes Grill Fastener Kit=43202</p>	 <p>41272 Grill Fordson Super Major c/w Holes -(RH + LH) Grill Fastener Kit=43202</p>	 <p>41769 Guard For Major Injector Pump Shaft</p>	 <p>41678 Badge Power Major Side</p>
 <p>41545 Foot Step Ford 5000 6600 RH</p>	 <p>41540 Foot Plate Ford 5000/6600 LH Foot Step Ford 5000 6600 LH</p>	 <p>41645 Foot Plate Upper Major LH & RH w/o Bracket ***Lower 42450***</p>	 <p>41754 Bonnet Hinge Fordson Major</p>	 <p>61485 Bonnet Clip 4200 Ford Super Major</p>
 <p>41303 Foot Plate Major 4 pcs - PAIR Suits 1952 to 54 tractor</p>	 <p>41302 Major Foot Plates Foot Plate Major LH & RH - PAIR Suits 1954 onwards & Power Major</p>	 <p>41270 Foot Plate Super Major - PAIR</p>	 <p>41392 PTO Guard Fordson Major</p>	 <p>41797 Dash Panel Major **Holes for gauges**</p>
 <p>51371 Right Hand</p> <p>51372 Left Hand</p>	 <p>43175 Mudguard Major Wing Type W/ Brake Hole Pair</p>	 <p>43176 Mudguard Super Major Disc Brakes Pair OE Ref: E1ADDN16312E</p>		

43175 is PAIR of Mudguards

Dexta Sheet Metal

Dexta

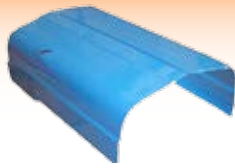

41378
Bonnet Dexta Complete



41344
Nose Cone Dexta - Steel



41299
Grill Dexta w/o Holes - PAIR



43202
Grill Fastener Kit
Dexta Major Power
Major Super Dexta
Super Major

Super Dexta

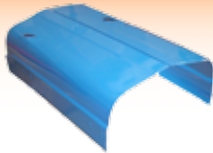

41644
Bonnet Super
Dexta



41345
Nose Cone Super Dexta
- Steel



41298
Grill Dexta c/o
Holes - PAIR

43173
Mudguard Dexta 21cm
Extension PAIR

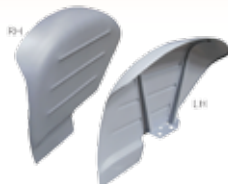

43172
Mudguard Ford 2000 3000
Square Pair



43174
Mudguard Ford 4000 5000
c/w Cab Section Pair

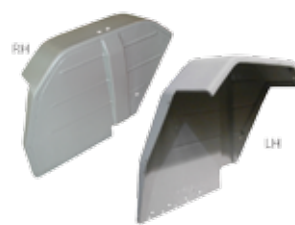

43171
Mudguard Ford 4000
5000 Round Type PAIR
LH & RH

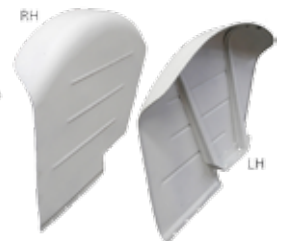

43225
Mudguard Ford 2000 3000
Pair

41301
Foot Plate Dexta - LH
& RH PAIR



42261
Nut & Bolt For
brackets on
41301



41891
Number Plate Brackets
Dexta
Lamp=41806



41512
U Bolt for Stabiliser
Fixing Bar Ford 2910 &
9 1/2" x 5" 15mm Thick
3910 4110 4620



41366
Stabiliser Bracket U Bolt
Ford 6610/7610
8 1/2" x 6 1/4" 15mm
Thick



41807
Bonnet Bracket Dexta
- PAIR

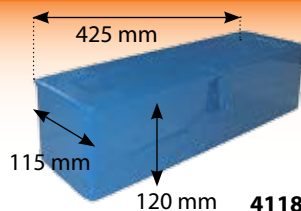

41182
Tool Box Blue

41927
Support
Bracket
Mudguard
Ford 2000 -
7600



41581
U Type Bolt Ford 3000
Mudguard 6" x 5" 10mm
Thick



Dexta Dash



41630
Dash Guard Dexta LH **
41629 is RH **



41629
Dash Guard Dexta RH
** 41630 is LH **



41796
Dash Panel Dexta
Holes for gauges

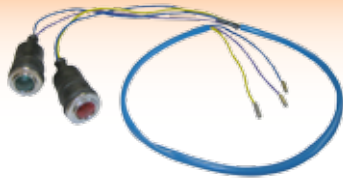

41822
Dash Lamp Dexta Red & Green
- PAIR Also fits Super Dexta **
Wiring loom is 41813 **

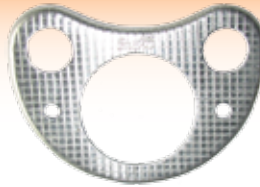

41823
Chrome Dash Dexta Suits
41822 Also Super Dexta



41848
Rubber Seal for Chrome Dash
Dexta
Suits 41823 Also Super Dexta



1044
Voltage Regulator Ford 11amp



41620
Voltage Regulator Ford 22amp



41901
Dexta Dash Panel Gasket

Sheet Metal

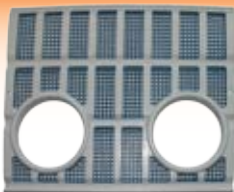

1382
Grill Ford 2000 - 7000 Lower



3655
Grill Ford 5000 Upper



4116
Grill Ford 26/36/46/66/7600
(600 Series)



41342
Grill Ford 2600 - 7600 - No
Light Holes Also 3900 4100
5900 Models

Sheet Metal



4403
Nose Cone Ford 3000
Front - No Hole



4734
Nose Cone Ford 2600
3600 c/o Dry Air Cleaner



4343
Nose Cone Ford 5600
Front - No Hole



41003
Nose Cone Ford 5600 -
7600 c/w Dry AirFilter

43331
Pre Force 01/65 03/68
Nose Cone Ford 100s 1000s 30s
300s 200s Industrial 3400 3500
3550 4400 4500 Pre Force
OE Ref: C5NN8N202AH



43332
Nose Cone Ford 100s 1000s 30s
300s 200s Industrial 3400 3500
3550 4400 4500 Pre Force 01/65
03/68 Bottom Surround
OE Ref: C5NN8N202BT



42246
Nose Cone Ford 4000
5000 6000 Complete



42245
Nose Cone Ford 2000 3000
Complete



4135
Grill Ford 6610 7610



41201
Grill Ford Pre Force Upper



41914
Dynamo Guard Ford 2000
7000 Pre Force Version

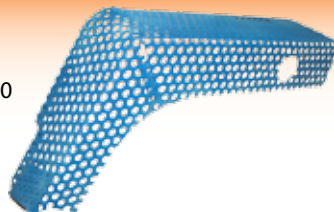

41264
Grill Ford Pre Force with Light
Holes



41332
Grill Knob & Nut
Ford 36-4600 Front



41332R
Grill Knob Ford
3600 - 4600 Front
OE Ref: 412575



41331
Radiator Grill Knob
Ford 2610-7610 c/o
Stud



42172
Grill Ford Chromed Steel
Force Upper ** 41955 is Metal
Ford Logo **



41955
Decal Kit Ford Metal
Writing Upper Grill

Bonnets & Components

 <p>LH RH</p>	<p>4955 Engine Hood Ford 2000 3000 LH</p> <p>4956 Engine Hood Ford 2000 3000 RH</p> <p>41174 Bonnet Kit Ford 2000 3000 LH & RH</p>	 <p>LH RH</p>	<p>4953 Engine Hood Ford 3600 3610 LH</p> <p>4954 Engine Hood Ford 3600 3610 RH</p> <p>41175 Bonnet Kit Ford 3600 3610 LH & RH</p>
 <p>LH RH</p>	<p>41176 Ford 5000 Bonnet Bonnet Kit Ford 5000 LH & RH</p>	 <p>4958 Engine Hood Ford 5000 RH *** Sell Kit No. 41176 ***</p> <p>4959 Engine Hood Ford 66 6610 LH *** Sell Kit No. 41177 ***</p>	
 <p>4957 Engine Hood Ford 5000 LH *** Sell Kit No. 41176 ***</p>	 <p>1277 Bonnet Nose Ford 5610 7610 Dry Air Cleaner Type</p>	 <p>43018 Bonnet Nose Oil Bath Type Ford 3610 4610 5610</p>	
 <p>41372 Bonnet Hinge Ford - PAIR</p>	 <p>43008 Bonnet Rubber Ford 2000 3000 5000 6600 6610</p>	 <p>41578 Roof Ford 4000 Cabin Metal</p>	 <p>41753 Bonnet Latch Fordson Major / Dexta</p>
 <p>41179 Bonnet Handle Ford 2000 3000 5000 6600 6610</p>	 <p>41643 Bonnet Panel Lock Ford LH RH Side 41369</p>	 <p>41369 Bonnet Panel Lock Ford RH LH Side 41643</p>	
 <p>41180 Engine Hood Catch Ford 2000 3000 5000 Also fits Ford 6600 6610 Bracket Rear</p>	 <p>43135 Engine Hood Catch Ford 2000 3000 5000 Also fits Ford 6600 6610 Bracket Front</p>	 <p>41181 Radiator Grill Clip 2000 3000 5000</p>	

Panels



41513
Battery Box Ford 2000
3000 Short Battery for 3
cylinder



41515
Battery Box Ford
3600 Long



41520
Battery Box Ford 4000 5000
Long - Before 1967

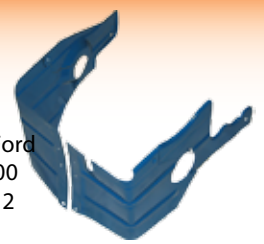

41488
Side Panel
Steering Box Ford
2000 3000 3600
Both LH / RH - 2
pcs



41507
2/3/4/5/7000 - Dash Panel
Ford 2000 3000 4000 5000
7000 2600 3600 4600 6600
7600

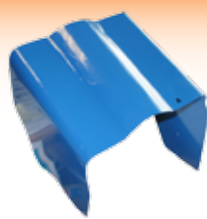

41799
Dash Panel Ford 2000 -
7600 Lower



42973
Dash Panel Screws Ford T6010
- T6080 T7030 -
T7060 TS90 - TS115
TS100A - TS130A



2836
Gas Strut Ford AP-220N - Door
Length 505mm - Ram 205mm



43070
Glove Box Lid Strut Ford TM140 50N
[OE Ref: 82014620](#)

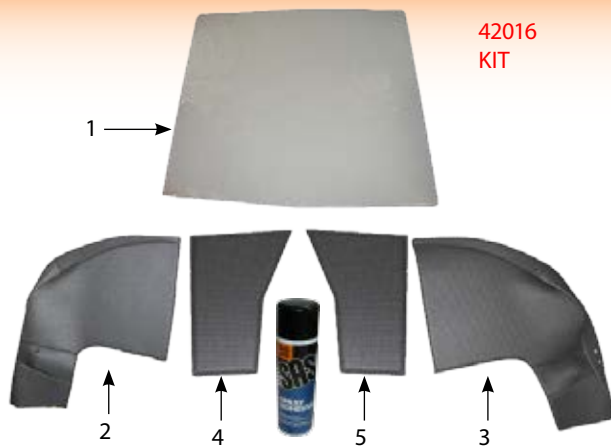

42016
KIT

42016
Cab Foam Kit Ford 4000 5000 7000
Safety Deluxe Cab

1. **41947** Roof Panel Ford Safety Deluxe Cab
2. **41948** Side Panel Rh Ford Safety Deluxe Cab
3. **41949** Side Panel Lh Ford Safety Deluxe Cab
4. **41950** Door Panel Rh Ford Safety Deluxe Cab
5. **41970** Door Panel Lh Ford Safety Deluxe Cab

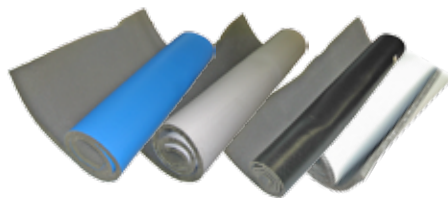

- C1491** Foam Sheet 1" Grey 6 x 4
- C1496** Foam Sheet 1/2" Black 6 x 4
- C1499** Foam Sheet 1" Blue 6 x 4
- C1490** Foam Sheet 1/2" Grey 6 x 4



3192
Rubber Matting 48" Castellated -
Sold Per Mt



42104
Steering Box Cover Ford 4000
5000 7000

Footsteps & Toolboxes

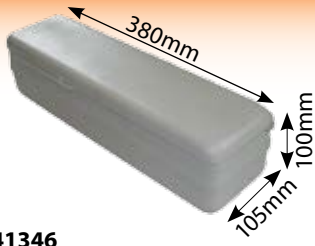

41346
Tool Box Ford 2000 5000

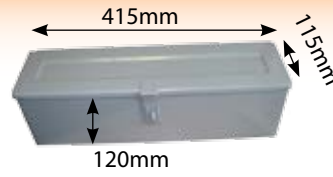

62604
Tool Box Ford 2000 3000 4000 5000 Grey
6600 6610

41182
Blue Tool
Box

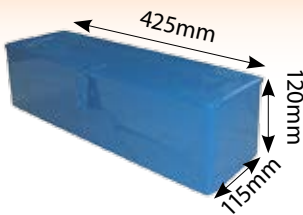

41787
Rubber for Ford 4000 5000
Mudguard - Per Mtr



41604
Foot Step
Ford 4000
Cab Type -
PAIR



41579
Mudguard RH Ford 4000/5000
c/w Cab Section



41605
Foot Step
Ford 5000 -
PAIR



41540
Foot Plate Ford 5000/6600
LH

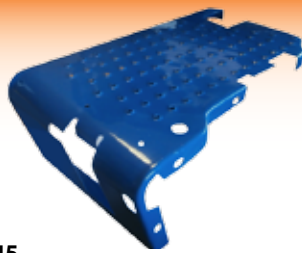

41545
Foot Plate Ford 5000/6600
RH



41411
Sell 41606 Kit

41410
***Sell 41606
Kit***



41606
Foot Step Ford 4000
Without Cab - PAIR



42176
Foot Step Ford
2000 3000 - PAIR



Date:.....

No. of Pages:.....

Name of the Rep.....

A/C Number:.....

From:.....

e-mail.....

Phone No.:.....

Fax No.:.....

Please quote for the following parts - Quotation Number :

I wish to confirm the following order on Quotation Number:

Please supply the following parts:

Please photocopy this page

Please do not remove this page

Qty	Part No.	Description	Unit Price
1.			
2.			
3.			
4.			
5.			
6.			
7.			
8.			
9.			
10.			
11.			
12.			
13.			
14.			
15.			
16.			
17.			
18.			
19.			
20.			
21.			
22.			
23.			
24.			

Comments:

Customer Signature: _____ **Rep's Signature:** _____

Tel No: + 353 44 934 1638

e-mail: info@qtponline.com, www.qtponline.com

Page of

TRACTOR PAINT

Hand brush or spray
Hardens to an OEM Finish
No colour variance

PLEASE NOTE:
Use QTP Thinners Only.
Follow directions on tin.

For a Professional Finish

1 Choose Paint
Spray or Brush

Choose
From a wide
range of colours

2 TR1488
1 Ltr Thinners

Mixing Ratio
Paint : Thinners
9:1 or 10:1



3 TR7000
1 Ltr Clear
Lacquer

Tough
Durable &
easy to use



MASSEY FERGUSON

- 1200TR** 35 4 Cylinder Gold
- TR1001** 35 4 Cylinder Red
- TR1180** 35X Ferguson Grey
- TR1187** Massey Ferguson Red
- TR1181** MF 100s Silver Mist
- TR1265** Massey Ferguson Flint Grey
- TR1399** Stoneleigh Grey
- TR1116** Transmission Brown / Charcoal Grey
- TR1000** 42 Series Chassis Black
- TR1002** Massey Ferguson 42 54 Red (New Red)
- TR1004** 42 Series Silver Mist
- TR1179** Smoke Grey
- TR1222** NH Driveline Grey - New Cab
- TR1225** Massey Ferguson Light Grey Pain
- 1191TR** Light Grey

RENAULT

- TR6615** Renault Grey
- TR6611** Renault Orange

SAME

- TR5501** Same Blue

FORD

- TR2440** Fordson Empire Blue
- TR3488** Fordson Orange
- TR1182** Ford Tractor Blue
- TR6616** New Holland Chassis Grey
- TR1071** Ford Grey
- TR1196** New Holland Ford Blue
- TR1221** New Holland Grey White for Wheels

FIAT

- TR3130** Fiat Brown
- TR3487** Fiat Opal White
- TR4188** Fiat Terracotta Brown
- TR3131** Fiat Orange
- TR3132** Fiat Cream

JOHN DEERE

- TR1162** John Deere Green
- TR2134** John Deere Yellow

LANDINI

- TR1065** Landini Blue

FENDT

- TR1060** Fendt Green

53208
Grey Primer
Wheel Spray
500ml Can



53207
Silver Paint
Wheel Spray
500ml Can



53210
Black Paint
Wheel Spray
500ml Can



53209
High Gloss
Black Paint
Wheel Spray
500ml Can



TRACTOR

PAINT

Hand brush or spray
Hardens to an OEM Finish
No colour variance

PLEASE NOTE:
Use QTP Thinners Only.
Follow directions on tin.

For a Professional Finish

TR1156



1 Litre

Red Oxide Primer

TR2397



1 Litre

Buff Primer Undercoat

TR1955



1 Litre

Grey Primer Undercoat

IHC/DAVID BROWN

- TR1163 IHC Off-White Wheels
- TR1231 International Red
- TR4703 Case/IHC Red New Red
- TR3489 David Brown Hunter Pink
- TR1184 David Brown Orchid White
- TR1184A David Brown Power Red

Deutz

- TR6617 Deuta Green
- TR6618 Deuta Green

ZETOR

- TR1193 Zetor Grey
- TR1183 Zetor Red
- TR1189 Zetor Chassis Green

LEYLAND

- TR1190 Leyland Light Blue
- TR1190A IHC / Leyland Dark Blue

WHITE/BLACK

- TR2175 Matt Black
- TR1109 Gloss Black
- TR1420 White

INDUSTRIAL

- TR1520 Old Hitachi Orange
- TR1003 New Hitachi Zaxis Orange
- TR1185 Industrial Yellow
- TR1198 New JCB Yellow
- TR1115 New Holland Clayson Yellow
- TR1160 New Ford Yellow
- TR1192 Komatsu Yellow
- TR1194 New Holland Yellow
- TR1195 Senator Lime Green
- TR1253 Rotavator Orange
- TR2393 Case Brown
- TR2396 New Cat Yellow
- TR2401 Case Tan
- TR2447 Kvernland Green
- TR3684 Land Rover Blue



- 59633**
JD Green Spray
Can Aerosol
400ml
- 59623**
JD Yellow Spray
Can Aerosol
400ml

NUFFIELD

- TR3490 Nuffield Orange/Red

Ford Super Q Cab Parts



41075
Gas Strut Bracket Ford Case John Deere
Case 484 584 684 784 884 John Deere
1030 1040 1130 1140 1630 940



58685
Plastic Nuts M8

Kit = 41075



58686
Screws M8

Kit = 41075



58687
Washer M8

Kit = 41075



58688
Plastic Coned Washer

Kit = 41075



58689
Tapped Housing M8

Kit = 41075



2919
Rubber Ford AP Glass to
Strut



4515
Rear Window Hinge AP Sekura
Explorer Cab David Brown 1190 1390
1490 1590 IH 1194 1394 1594 1694
McCormick Back Window



4774
Mudguard Flap Ford LH 10s 8530
TW15 TW25 TW5



4505
Window Fitting & Handle



OD 75.29mm Height
51.57mm
Overall Height 70mm

3805
Cab Mounting Ford Super Q - Rear - 1 Inch



3810
Cab Mounting Ford
Super Q - Front

Ford Super Q Cab Rear Window Components



41075
Gas Strut Bracket Ford Case John Deere



1071
Switch Ford Super Q Roof Light



41917
Light Switch Ford 10 Series TW 30 Series



4261
Window Handle Ford AP Cab Rear David Brown & IH Sekura Explorer Cab 1190 1290 1390 1590 1690 John Deere SG2



1563
Wiper Motor Ford Super Q TW5 TW35 10

3718
Door Lock Q Cab RH/ Sankey RH



3719
Door Lock Q Cab LH / Sankey LH



S4040
Door Slam Lock Ford Inner 2000 2600 3000 3600 4000 4100 4600 5000 5600 6600 7000 7600(3058 outer/4571 inner)



3058
Door Locking Handle Ford Q Cab



4571
Door Handle Inside Tap On



4315
Door Lock Ford Super Q Cab LH Inner

4316
Door Lock Ford Super Q Cab RH Inner



4318
Fixing Plate RH



4317
Door Handle & Lock Ford Super Q Cab Outside

Mirrors, Mirror Arms

4395
Mirror Arm Ford Super
Q 13' Throw Out Top to
Bottom 30" Throw out 13"

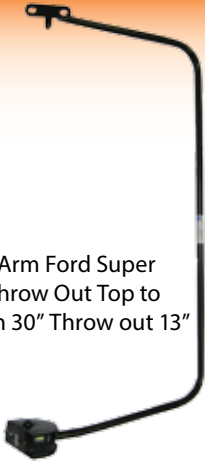

2590
Mirror Arm 8"



2589
Mirror Arm 12"

2591
Mirror Arm 16"

1241
Mirror For Interior - 147mm x
97mm
Super Q



1254
Mirror Head 7' x 5'



2325
Mirror Ford Q Cab 10 1/2
x 6 3/4



6480025
Mirror 237 x 180 16mm 18mm 20mm
Clamps Ford 7840 Convex Suits Q Cab
Fiat Deutz Same Lamborghini Massey
Ferguson



2042GL
Mirror Glass Convex for 2042 Ford
40's (257mm x 157mm) **2325GL is
Flat ** Massey Ferguson 42s 43s



409690
Mirror Ford 40 TS 81-85 60
Rear View LH **Mirror to Suit
409928** (Blue Roof)



409691
Mirror Ford 40 TS 81-85 60
Rear View RH **Mirror to Suit
409928** (Blue Roof)

409928
Mirror Ford 40 TS 81 - 8560 Rear View
Suits 409691 & 409690 (10 x 6)



2042
Mirror Ford 7840 Convex 10 1/2" x 6
3/4" Also suits Q Cab



1191
Mirror Assembly Ford 40s



2042GL
Glass Mirror

Mirrors, Mirror Arms



41102
Mirror Ford 8160-8970 M TM
TR TS Rear View

2042GL
Mirror Glass



409680
Mirror Arm Ford 60 TM
TS RH** LH is 409679 **
Mirror is 41102 **

409679
Mirror Arm Ford 60 TM
TS LH ** RH 409680 **
Mirror is 41102 **



42098
Mirror Arm TSA T Series RH
** Mirror is 41101 ** Glass
41101GL **

42099
Mirror Arm TSA T Series
LH ** Mirror is 41101 **
Glass 41101GL **



41101
Mirror Ford 60/70/M/TM/TR/
TS's Rear View Telescopic 12
1/2" x 9" - 320 x 230mm **
Mirror Arm Is 42098 **

41101GL
Glass Mirror

42947

Mirror Arm RH Ford T7030 6040 6020 7050 7040
7060 6060 With Cable Case Puma 115-215 CVT **
Electric Mirror head is 53748 ** Switch is [OE Ref: 87497692](#)

42946

Mirror Arm LH Ford T7030 6040 6020 7050
7040 7060 6060 With Cable Case Puma 115-215
CVT [OE Ref: 87346605](#)



53748
Mirror Remote Control
Heated Electric Left Hand /
Right Hand
[OE Ref: 4288898M91](#)



42950
Mirror Glass for 42948 &
42949 For Heated Electric
Mirror 315 x 225mm



43329
Switch Electric Mirror
Adjustment Ford



409616 LH / 409617 RH
Mirror Ford TM115-165 LH Telescopic Rear View (99-02)
8160-8560 (95-00) TS90-115 (97-03)



43024
Mirror Arm New Holland TD60 TD70 TD80 TD90

Gas Struts

43070



Application	Models
Glove Box Lid	TM140

Force (N)	Length (mm)	Ram (mm)	OE Ref
50N	195	65	82014620

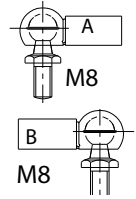

2836



Application	Models
Door	2910, 3610, 3910, 4110, 4610, 5610, 6610, 7610 3430, 3930, 4630, 4830, 5030

Force (N)	Length (mm)	Ram (mm)	OE Ref
220	505	205	83944272

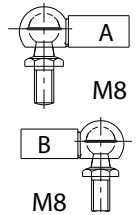

41767



Application	Models
Door	5640, 6640, 7740, 7840, 8240, 8340 8160, 8260, 8360, 8560 TM110, TM115, TM120, TM125, TM130, TM135, TM140, TM150, TM155, TM165, TM175, TM180, TM190 TS100, TS110, TS115, TS80, TS90

Force (N)	Length (mm)	Ram (mm)	OE Ref
310	215	57	87378324

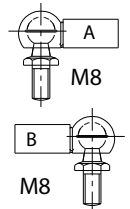

43532



Application	Models
Door	T6050 T6060 T6070 T6080 T7030 T7040 T7050 T7060 TS100A TS110A TS115A TS125A TS130A

Force (N)	Length (mm)	Ram (mm)	OE Ref
850	215	115	87374182

42772



Application	Models
Steering column	T6010, T6020, T6030, T6040, T6050, T6060, T6070, T6080, T6090 T7030, T7040, T7050, T7060, T7070 TS100 A, TS110 A, TS115 A, TS125 A, TS130 A, TS135 A

Force (N)	Length (mm)	Ram (mm)	OE Ref
350	235	70	82036016

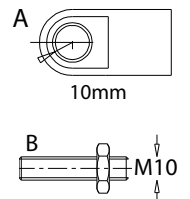

2835



Application	Models
Front window	2910, 3610, 3910, 4110, 4610, 5610, 6610, 7610

Force (N)	Length (mm)	Ram (mm)	OE Ref
100	255	90	83944280

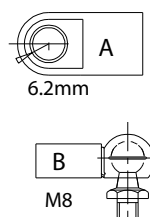

Gas Struts



43164

Application	Models
Bonnet	TS100, TS110, TS115, TS80, TS90

Force (N)	Length (mm)	Ram (mm)	OE Ref
450	685	300	82011092

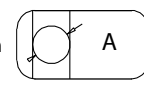

10mm A

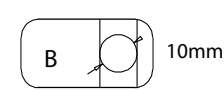

B 10mm



41766

Application	Models
Bonnet	8160, 8260, 8360, 8560 TM115, TM120, TM125, TM130, TM135, TM140, TM150, TM155, TM165

Force (N)	Length (mm)	Ram (mm)	OE Ref
500	900	400	82019392

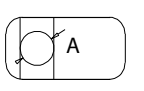

10mm A

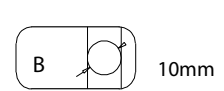

B 10mm



43567

Application	Models
Bonnet	New Holland T6000 Series T7 Series

Force (N)	Length (mm)	Ram (mm)	OE Ref
900	765	340	84277822

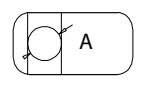

A

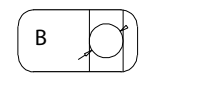

B



52490

Application	Models
Bonnet	New Holland TS100A TS115A TS125A TS135A

Force (N)	Length (mm)	Ram (mm)	OE Ref
900	690	300	82032866

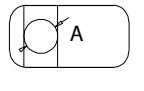

A

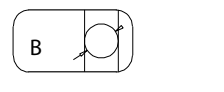

B



43663

Application	Models
Bonnet	New Holland 35 Series TL Series

Force (N)	Length (mm)	Ram (mm)	OE Ref
310	580	250	5166403

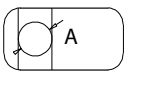

A

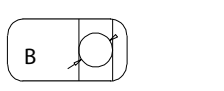

B

Ball Ends

- | | | | |
|-------------|-------------------|-------------|-------------------|
| 4039 | Ball End 5 x 1 | 4042 | Ball End 10 x 1.5 |
| 4040 | Ball End 6 x 1 | | |
| 4041 | Ball End 8 x 1.25 | | |



Gas Struts

2699



Application	Models		
Sun roof	2610-8210 8530-8830 5640-8340 8160-8560 M100-M160 TM110-TM180 TS90-TS115 TW5- TW35 5900		
Force (N)	Length (mm)	Ram (mm)	OE Ref
220	220	65	83949895

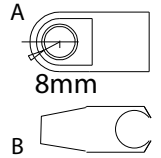

4715



Application	Models		
Door/Sun roof	2610, 3610, 4110, 4610, 5610, 6410, 6610, 6710, 6810, 7410, 7610, 7710, 7810, 7910, 8210 3230, 3430, 3930, 4630, 8530, 8630, 8730, 8830 TW15, TW25, TW35, TW5 5900		
Force (N)	Length (mm)	Ram (mm)	OE Ref
300	210	55	83952266

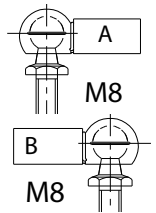

52215



Application	Models		
Sun roof	1190, 1290, 1390, 1490, 1690 1194, 1294, 1394, 1494, 1594, 1694		
Force (N)	Length (mm)	Ram (mm)	OE Ref
330	220	67	3901826M91

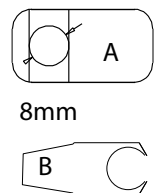

2107



Application	Models		
Rear window	2610, 3610, 4110, 4610, 5610, 6410, 6610, 6710, 6810, 7410, 7610, 7710, 7810, 7910, 8210 8530, 8630, 8730, 8830 TW5- TW35 5900		
Force (N)	Length (mm)	Ram (mm)	OE Ref
160	375	150	83952213

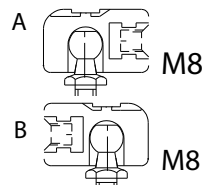

61951



Application	Models		
Rear window	5425-5480 6110-6190 6235-6290 6445-6499 7465-7495 8110- 8180 8210-8280		
Force (N)	Length (mm)	Ram (mm)	OE Ref
150	585	255	3902140M1

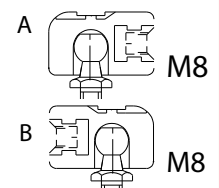

Gas Struts

2834



Application	Models		
Rear window	2610, 2910, 3610, 3910, 4110, 4610, 5110, 5610, 6410, 6610, 7410, 7610, 7710 3230, 3430, 3930, 4630, 4830, 5030		
Force (N)	Length (mm)	Ram (mm)	OE Ref
200	500	210	83932024

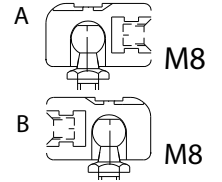

407119



Application	Models		
Rear window	4635, 4835, 5635, 6635, 7635 5640, 6640, 7740, 7840, 8240, 8340 8160, 8260, 8360, 8560 L60, L65, L75, L85, L95 M100, M115, M135, M160 TL100, TL100A, TL70, TL70 A, TL80, TL80A, TL90, TL90A TM110-TM190, TS120, TS80, TL80 A -TL100 A		
Force (N)	Length (mm)	Ram (mm)	OE Ref
220	585	255	81865239

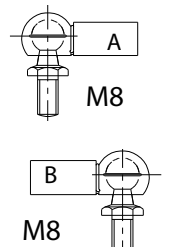

61285



Application	Models		
Rear window	3050, 3060, 3065, 3070, 3075, 3080, 3085, 3090, 3095, 3115, 3120, 3125 3610, 3630, 3635, 3645, 3650, 3655, 3670, 3680, 3690		
Force (N)	Length (mm)	Ram (mm)	OE Ref
250	785	350	3389556M2

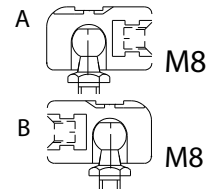

43533



Application	Models		
Rear window	T6040 T6050 T6060 T6070 T6080 T7030 T7040 T7050 T7060 TS100A TS110A TS115A TS125A		
Force (N)	Length (mm)	Ram (mm)	OE Ref
485	485	245	82022486

Ball Ends

4039 Ball End 5 x 1
4040 Ball End 6 x 1
4041 Ball End 8 x 1.25

4042 Ball End 10 x 1.5



Powershift Joystick Push Switches

Ford 8160 » 8560 New Holland TM115 » 190, M100 » M160



43154BL
Joystick Switch Push **Blue**



43154OR
Joystick Switch Push **Orange**



43154WH
Joystick Switch Push **White**



43154
Joystick Switch Push **Red**



43154GR
Joystick Switch Push **Green**



40's Cab Parts



409854
Cab Mounting Ford 35 40 60 M TL
TM TS Front

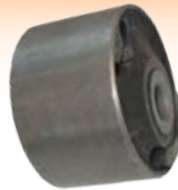

409855
Cab Mounting Ford 40 60 M TM TS -
Rear T6000 Front Also suits Massey
Ferguson 6445 6455



42111
Cab Blower Ford 40 60 TM TS Also fits
Case JX MXM



409644
Head Lamp Panel Ford 40 Front Bezel



409836
Head Lamp Ford 40

40's TS Cab Parts

409786
Retainer Ford 40's/TS for Side Panel



409785
Retainer Latch Ford 40's/TS for Side Panel



43504
Side Panel Retainer Kit Ford 40s



409714
Mudguard Clip Ford 40 Side Extension



409766
Door Hinge Ford 40 M
TL TS RH



42103
Door Hinge Pin Ford
40 60 TM TS ** Suits
409766 & 409788 **



409788
Door Hinge Ford 40's/M/
TL/TS LH



42025
Door Handle Outer Ford 40 Series
Suits TL & TS 60



404888
Door Latch Assembly Ford
7840 8340 LH 5640 6640 7740
8160 8240 8260 8360 M100 -
160 TL70 - 100 TS90 - 115



42108
Dash Cover for Clock Ford
8360 6640 TL100A 8240
5640 8160 8340 7740 8560
8260



409715
Beacon Mounting Plate
Ford 40

402948
7840/8240/8340
480mm
Fender (Pair)

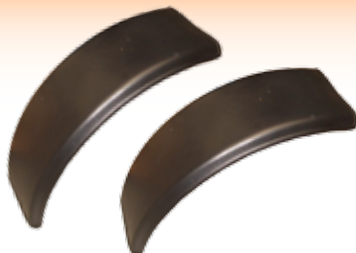

402947
7840/8240/8340
380mm
Fender (Pair)



43548
Passenger Seat Ford 5640 6640 7740 7840 8240 8340 **OE**
Ref: 82008831

40's Cab Parts

409728

Knob Ford 40 SL
Forward / Reverse
c/o switch



409727

Start Knob Assembly
Ford 40's Hi/Lo



409699

Transmission
Lever Ford 40
(Orange Gear
Knob)



409658

Indicator Switch
Ford 40 - Flasher
Start Year 91



42208

Console Plastic Gear Boot Ford 7840
** Gear Boot is 42088 ** ** Complete
Kit is 42207 **



42088

Gear Lever Boot
Ford 7840



42207

Gear Lever Boot Ford
7840 & Plastic Console



409906

Battery Cover Ford 40's



43015

Battery Cover Ford New
Holland TS90 TS100 TS110
TS115



43531

Battery Tray New Holland TMs
8360s 4WD
OE Ref: 82018950

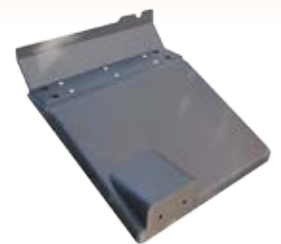

43700

Mudguard Extension Ford 3435
3935 4135 Fiat 45-66 50-66 56-
66 Left Hand OE Ref: 5129328

40's TS Cab Parts



409903
Window Handle Ford 40 60
70 TM TL TS M Back ** Kit
41548 **



41548
Latching Kit for Back
Window Ford TS



409697
Pin Ford 40 TM TSA TS For
Handle Back Window ** Kit 41548 **

409694

Washer Ford 40 TM TS TSA Back
Window Small(Upper) on back
window Frame (Rubber) 2 required
to fit 402940 ** Kit 41548 **



409695

Washer Ford 40 TM TS TSA Back
Window Big (Lower) on back window
Frame (Steel)



409693

Window Screw Ford 40's TM
TS TSA - Back Frame (M12 x
50)



409902

Window Rubber Ford 40's
Back



409696

Spacer Ford 40 TM TSA TS
on Handle Back For Back
Window



409698

Cap Ford 40 TM TSA TS
for Back Window



42225

Hinge Bracket Ford TS100
LH Side Window



42227

Hinge Bracket Cover Ford
TS100 RH Side Window



42226

Hinge Bracket Cover Ford
TS100 LH Side Window



42224

Hinge Bracket Ford TS100 RH
Side Window



42222

Brake Light Switch Ford Super Q Also Fits 10 30 35 TN
Series Case JX1060 V JX1070 JX1075



409659

Brake Switch Ford Hi/Low Forward / Reverse Clutch - Brake
Light Switch 30 40 60's Ford M TL TM TS - Case CS CVX JX



TL/TM/TS Cab Parts

TS Grills & Components



409632
Grill Ford TS Front
Upper



43125
Grill Ford TL100
TL70 TL80 TL90



43643
Lock Housing Front Grill
TSTSA [OE Ref: 82013276](#)

409631
Grill Ford TS Lower
Front



42129
Grill Ford TM & 60
Series Front
8160 8260 8360 8560
TM115 TM120 TM125
TM130 TM135 TM140
TM150 TM155 TM165

409630
Latch Ford TS TM TSA 60 to hold
Hood



43346
Front Grill Assembly
Ford TS with Head
Lamps
[OE Ref: 82012531](#)



43614
Side Panel New Holland TM
Right Hand Bonnet Support
[OE Ref: 87376530](#)

43615
Side Panel New Holland TM
Left Hand Bonnet Support
[OE Ref: 87376528](#)



43071
Door Handle Ford TM



42903
Radio Aerial Extension Cable
TM T6000 Series



43509
Door Hinge Ford T5000 TL TLA TM TS
TSA RH Lower LH Upper
[OE Ref: 82018445](#)

43508
Door Hinge Ford T5000 TL TLA TM
TS TSA RH Upper LH Lower
[OE Ref: 82018444](#)



41341
Door Cable Spring Ford TL TM TS



42940
Foot Throttle Pedal Ford TM TS
TSA TL TLA T4000 T5000 T6000
T7000 M Series 60 Series

41340
Door Latch Screw Ford
TL/TM/TS Inner



42106
Door Lock Ford TM TL
TS TLA - LH

41338
Door Cable Ford TL TM TS

T6000/T7000/T6/T7/TSA Cab Parts



43148
Shock Absorber Cab
Suspension TM120
TM135 TM140 TM155
TM175 TM190

43584
Mudguard Extension
New Holland T6000 T6
T7 TSA Steyr LH
OE Ref: 82038501



43585
Mudguard Extension New
Holland T6000 T6 T7TSA
Steyr RH
OE Ref: 82038500



43200
Shock Absorber Cab
Suspension T7030 T7040
T7050 T7060 T6080



43626
Sunroof T7 Series OE Ref: 84318628



43201
Shock Absorber Cab
Suspension T6010 T6020
T6030 T6040 T6050 T6060
T6070 TS100A TS100A
TS110A TS115A TS125A
TS135A



42146
Door Lock Ford T TSA LH



43194
Cab Mounting Ford T6030
T6050 T6070 T6080 T7030
T7040 T7050 T7060



41653
Snap Ring Pin on Gear Lever &
Door Ford L 35 M T6000 TD TL
TM TSA

Wiper Motors

1008

Kit = 4169



Wiper Motor 12 Volt 110 Degrees Small Tapered c/w Switch - Shaft Length 58mm

3859

Kit = 4195



Wiper Motor 12 Volt 90; Small Tapered Shaft c/w Switch Used in kit 4195 (Shaft length 58mm)

3860



Wiper Motor 24 Volt 90; Small Tapered Shaft c/w Switch - Shaft length 58mm

4169



Wiper Motor Kit 12 Volt 110; c/w Arm & Blade Shaft Length 58mm

4195

Motor = 3859



Wiper Motor Kit 12 Volt 90; c/w Arm & Blade Shaft Length 58mm

6671



Wiper Motor 300 12V 115; Small Tapered Shaft (Shaft length 78mm)

6645

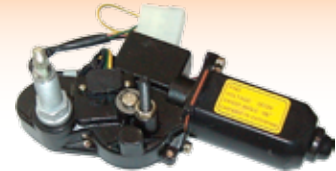

Wiper Motor 390 12V 105; Large Tapered Shaft Shaft length 33mm

63240



Wiper Motor Front 54s 42s 43s

1563



Wiper Motor Ford Super Q TW5 TW35 10

59283



Wiper Motor John Deere 6000

51027



Wiper Motor John Deere SG2 12V 90;

51061

Arm = 2207
Blade = 1619



Wiper Motor 5400 6100 6200 6400 7400 8100 Also Fits 8200 - For Rear Window

51059

Arm = 2207
Blade = 1619



Wiper Motor 390 398 105; Shaft Length 48mm

Wiper Motors

2494

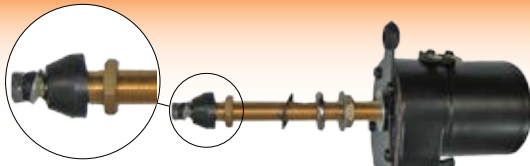

Wiper Motor 12 Volt 105 Degrees
Small Tapere

2493

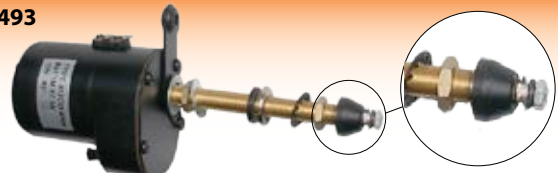

Wiper Motor 12 Volt 85 Degrees
Small Tapered

41656

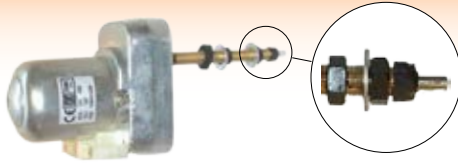

Wiper Motor 12 Volt 120
Straight Single Spin
Shaft Length 99mm

51045

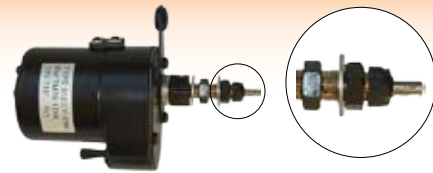

Wiper Motor 12 Volt 110 Short Stem
Straight Shaft Length 46mm
Arm ref is 4296

2491

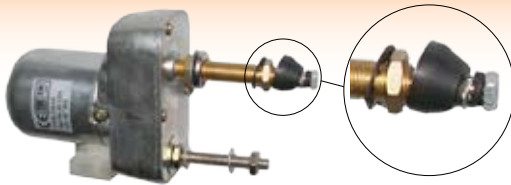

Wiper Motor 12 Volt 80 Small Tapered Shaft
Shaft Length 58mm - Check Type of Cab

2492

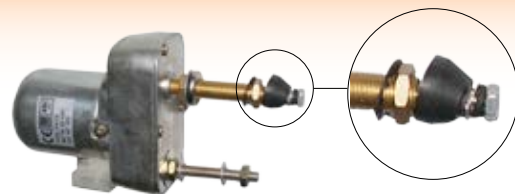

Wiper Motor 12 Volt 110 Small Tapered Shaft
Shaft Length 58mm

51025

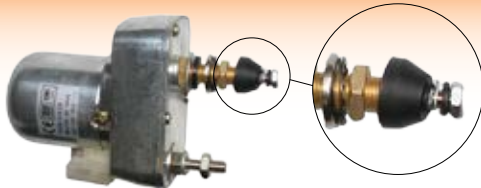

Wiper Motor Case 12V 135 Small Tapered Shaft
Shaft Length 34mm

51026

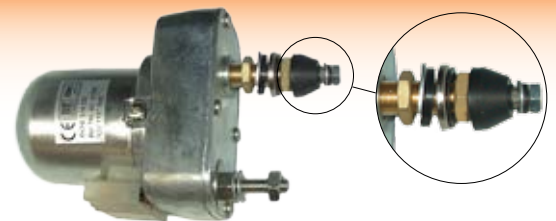

Wiper Motor Case 12V 115 Small Tapered Shaft
Shaft Length 34mm

51260



Wiper Motor 12 Volt 90
Small Tapered Shaft
Wiper Motor With Cover &
Switch - Shaft 48mm

51006

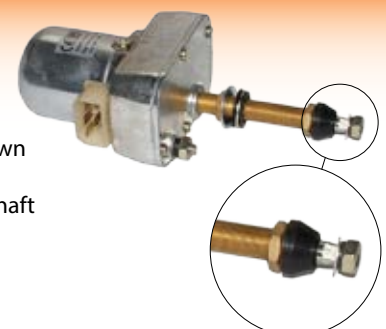

Wiper Motor David Brown
12V 95
Large Tapered Shaft - Shaft
Length 80mm

Wiper Arms

Photo	Part No	Motor Type	Description	Length	
				Inches	mm
	4296	Straight Shaft	Wiper Arm	18"	457.2
	2014	Straight Shaft	Parallel Arm	18"	457.2
	2207	Tapered Shaft	Wiper Arm		
	1897	Tapered Shaft	Parallel Arm Blade=1619	19½"	500
	51497		Wiper Arm	15½"	400
	51008		Wiper Arm MF 600's	19½"	500
	2870		Wiper Arm Ford Super Q & Q Cab Blade=2837	17"	431.9
	4894		Wiper Arm Large Hole	15½"	400
	43701		Wiper Arm Ford New Holland35, 40, 60, T5000 Series		





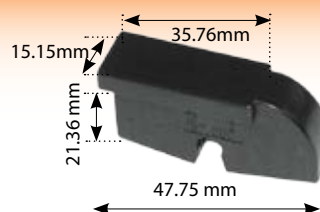









409692
Clip Ford 40 TM TS on Front
Windshield Wiper Deluxe



409635
Adaptor for Wiper Blade
Ford 60 TM TS (Front)

Wiper Blades

Photo	Part No	Description	Length	
			Inches	mm
	2206	New 1008 Motor		400
	2246	Wiper Blade	17½"	450
	4685	Wiper Blade	24"	609.6
	1619	Suit 1897 Wiper Arm	20"	508
	6753	SUIT 600/3000'S		600
	61941	42/43/61/62/81/82's ALSO 5400 6400 7400 Case Ford DB Fiat Deutz JD Leyland	20"	508
	2837	Ford Q & Super Q Cab John Deere 50's SG2 Cab Wiper Arm =2870		500
	51009	Case XL		650
	62039	Wiper Blade Front J.Deere 6000/10/20 Front and Rear for 50HX	23½"	600
	59803	Wiper Blade Rear John Deere 6000/10/20		
	780048	Wiper Blade Renault TS/TX		
	62283	Wiper Blade	28"	700
	404895	Ford 40 TS TM M		550

Glass Fritzmeier Glass

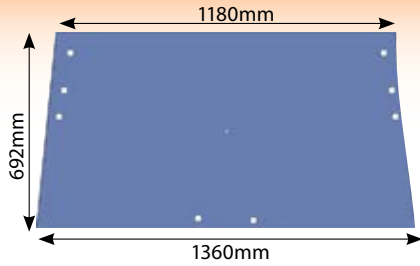

3287
Glass Ford Fritzmeier
Rear Window

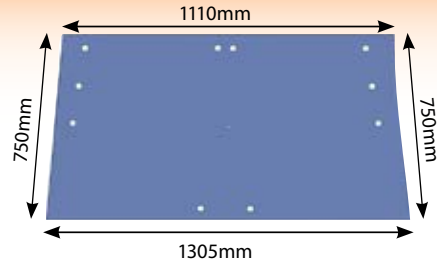

3286
Glass Ford Fritzmeier
Windscreen

Ford Sekura Low Profile Glass

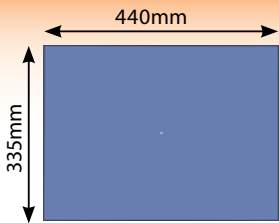

4589
Glass Ford AP Lower Rear

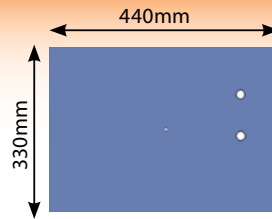

4590
Glass Ford AP Lower Rear c/o Holes

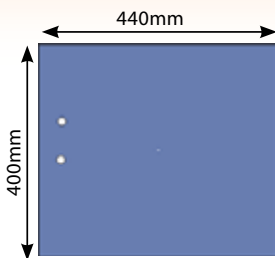

D6774
Glass Ford 7610 Sekura Lower
Rear Sliding

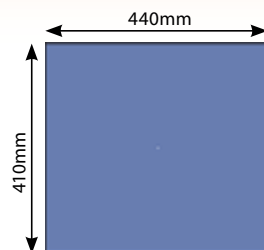

D6773
Glass Ford Sekura 7610 Lower
Rear Fixed

Pre-Fritzmeier Glass

43184

Glass Rear Window Lower Safety Frame Standard & Deluxe
Cab Ford 4000 4100 4600 5000 5600 6600 7000 7600



43185

Glass Rear Window Upper Safety Frame Standard & Deluxe
Cab Ford 4000 4100 4600 5000 5600 6600 7000 7600

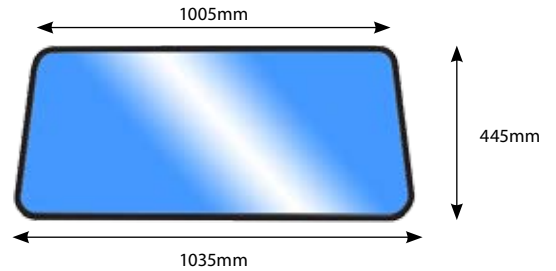

43181

Window Frame Ford Rear Lower 3000 4000 5000 7000



43180

Window Frame Ford Rear Upper 3000 4000 5000 7000



3460

Glass Ford 3000 4000 5000 7000 Top
Door
Pre Frit

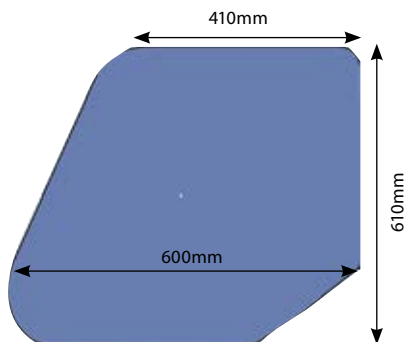

43622

Sliding Glass Ford 4600 5600 6600 7600 4000
4100 5000 7000 7100 7200 Left Hand Right Hand
Safety Cab [OE Ref: 81822890](#)

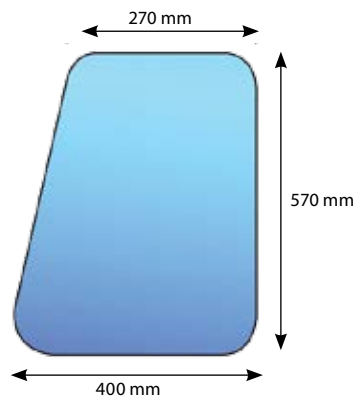

43624

Rubber Sliding Door
Glass Ford 4600 5600
6600 7600 4000 4100
5000 7000 7100 7200
One Side
[OE Ref: 81827487](#)

Glass

Ford 6610/7610 AP Cab Glass

2221

Glass Ford Windscreen AP Cab

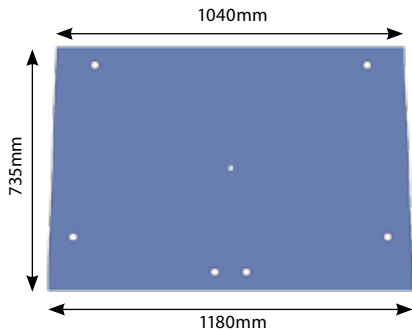

2222

Glass Ford AP Cab Side Window

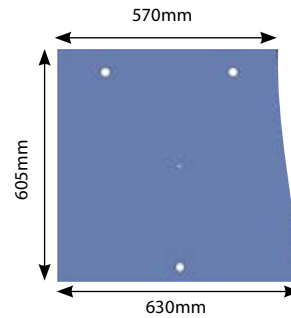

2223

Glass Ford AP IHC Super Deluxe Top Rear Glass

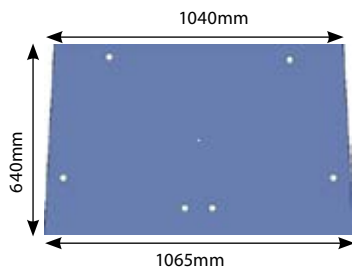

2224

Glass Ford AP Cab Lower Front Glass

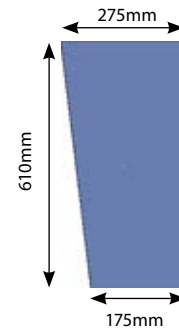

2226

Glass Ford AP Cab Top Door

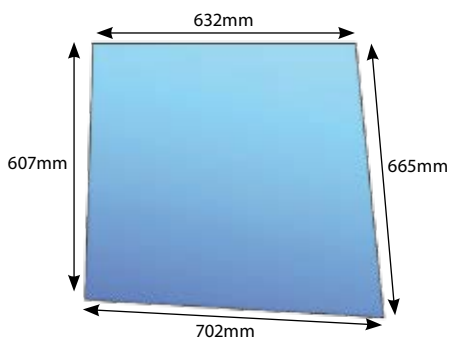

2220

Bottom Door Glass

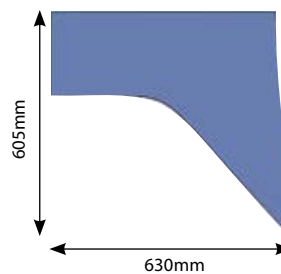

F2220

AP RH Lower Door Glass Framed

D6781

AP LH Lower Door Glass Framed



Date:.....

No. of Pages:.....

Name of the Rep.....

A/C Number:.....

From:.....

e-mail.....

Phone No.:.....

Fax No.:.....

Please quote for the following parts - Quotation Number :

I wish to confirm the following order on Quotation Number:

Please supply the following parts:

Qty	Part No.	Description	Unit Price
1.			
2.			
3.			
4.			
5.			
6.			
7.			
8.			
9.			
10.			
11.			
12.			
13.			
14.			
15.			
16.			
17.			
18.			
19.			
20.			
21.			
22.			
23.			
24.			

Please photocopy this page

Please do not remove this page

Comments:

Customer Signature: _____ **Rep's Signature:** _____

Tel No: + 353 44 934 1638

e-mail: info@qtponline.com, www.qtponline.com

Page of

Glass

Ford 4600 Cab Glass

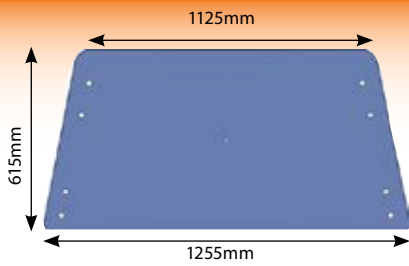

1444
Glass Ford 4600 Rear Window

Ford Q Cab Glass

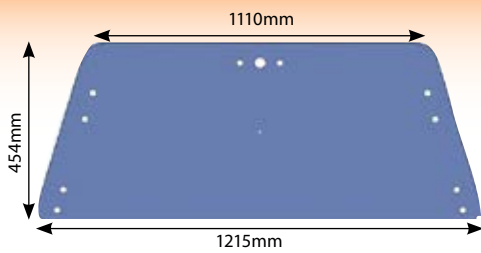

4101
Glass Ford Q
Cab Upper
Rear Clear

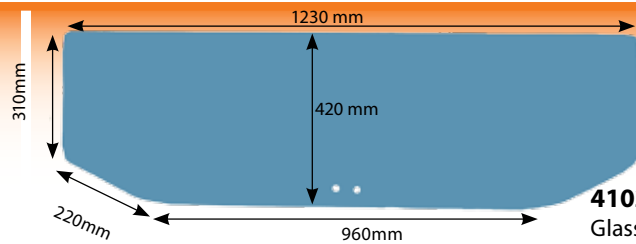

4102
Glass Ford Q
Cab Bottom
Rear

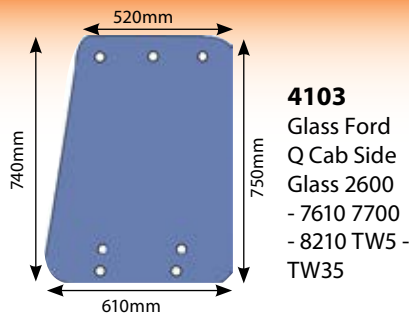

4103
Glass Ford
Q Cab Side
Glass 2600
- 7610 7700
- 8210 TW5 -
TW35

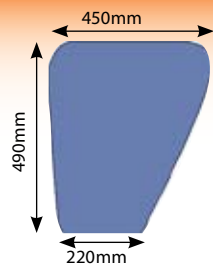

4591
Glass Ford Q
Cab Bottom
Door

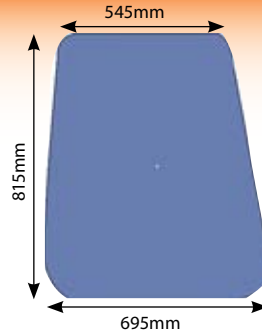

4582
Glass Ford Q
Cab Upper
Door

Ford Super Q Cab Glass

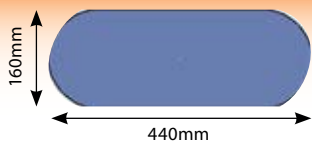

D6750
Glass Ford Super Q Bottom Rear
Hitch Lookout Glass

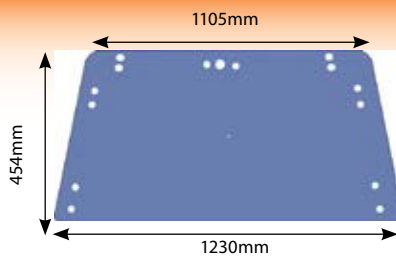

2409
Glass Ford Super Q Upper Rear
Glass Tint

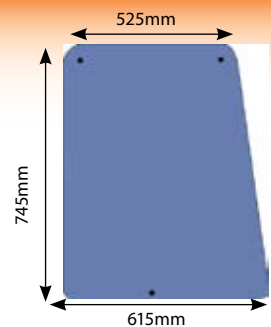

4593
Glass Ford Super Q Side Glass

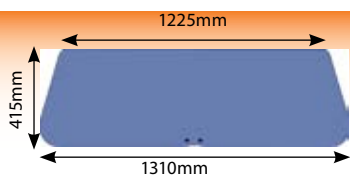

D6748
Glass Ford Super Q Lower
Rear Green
Same as 4102

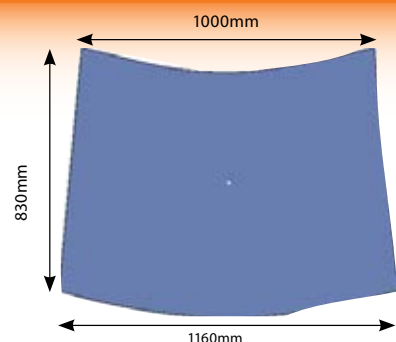

Q & Super Q Windscreen

4914
Glass Ford Q Cab & Super Q
Windscreen

L /35 Series Glass

7368

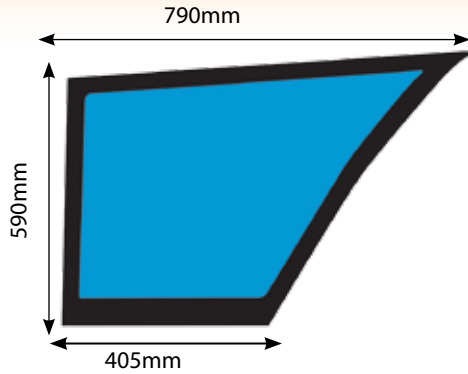

Glass Door Fiat L60 L65 L75 L85 L95 New
Holla 4635 4835 5635 6635 7635

7362

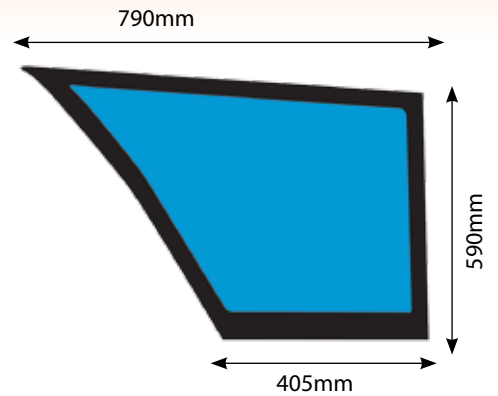

Glass Door Fiat L60 L65 L75 L85 L95 New
Holland 4635 4835 5635 6635 7635

7351

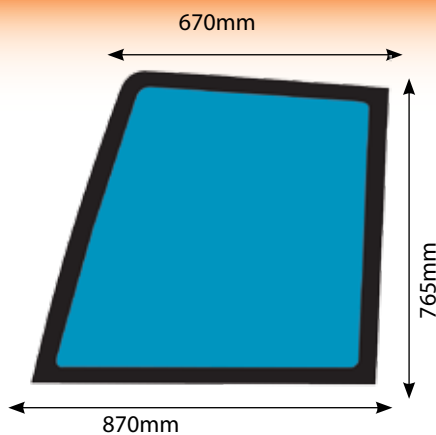

Glass Door Fiat L60 L65 L75 L85 L95 New Holland
4635 4835 5635 6635 7635

7349

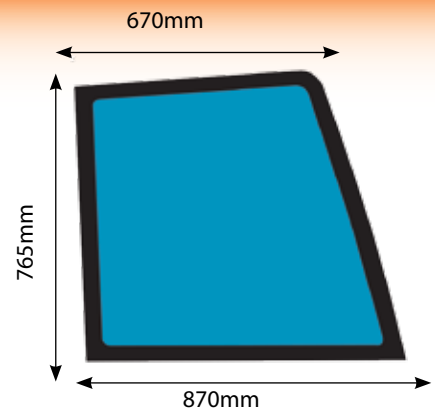

Glass Door Fiat L60 L65 L75 L85 L95 New Holland 4635
4835 5635 6635 7635

30 Series Glass

43625

Glass Ford 5030 - 4830 Rear
OE Ref: 81875338

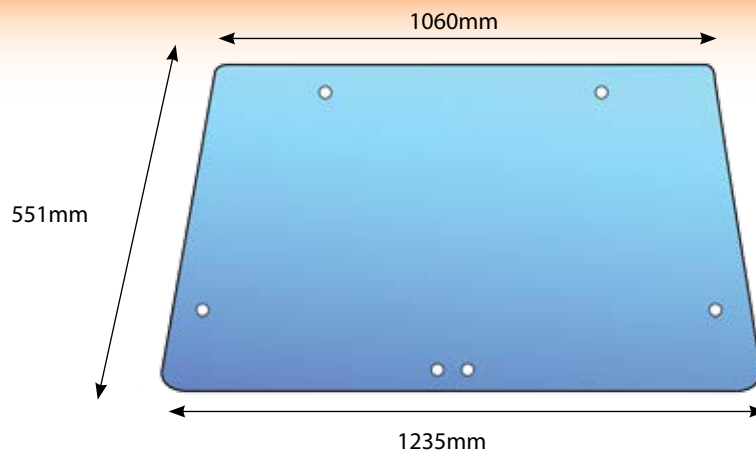

Glass

Ford T/TS/TM Cab Glass

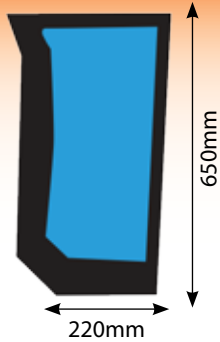

43166
Glass Ford TS TS100 TS110
TS115 TS80 TS90 Lower
Front LH
OE Ref: 82011531

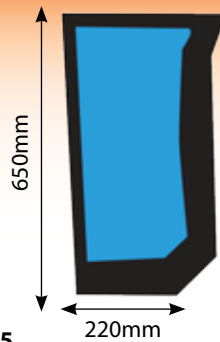

43165
Glass Ford TS TS100 TS110
TS115 TS80 TS90 Lower
Front RH
OE Ref: 82011532

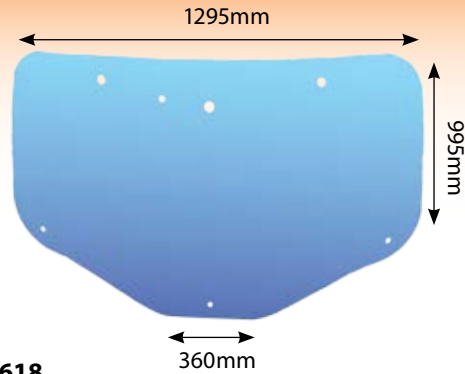

41618
Glass Ford TSA & Case MXU
7 Holes Rear Case MXU 100 -
135 TSA 100 - 135 T6 T7

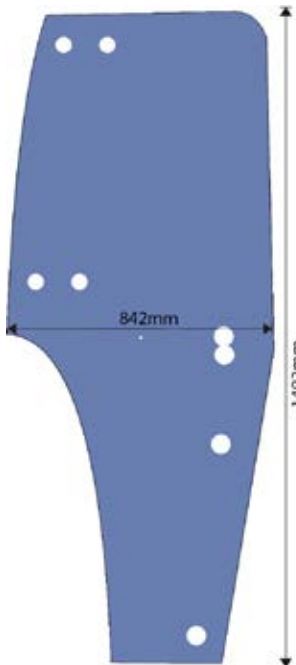

PLEASE MAKE SURE WHEN FITTING THE DOOR GLASS THAT THE HINGE MARKED TOP IS RETURNED TO THE TOP POSITION AND THE HINGE MARKED BOTTOM IS RETURNED TO THE BOTTOM POSITION. OTHERWISE THE GLASS WILL BREAK ON CLOSING.

41077
Glass Ford TM TS TL Door
RH - 7 Hole TS90-TS115
TM115-TM190 TL70-TL100
TL70A - TL100A MXM120-
MXM190 JXU

41078
Glass Ford TM TS Door LH - 7
Hole TS90-TS115 TM115-
TM190 TL70-TL100 TL70A
- TL100A MXM120-MXM190
JXU



43073
Door Hinge TM TL TS
Top RH Bottom LH

43072
Door Hinge TM TL TS
Top LH Bottom RH



43080
Rubber For Door Hinge
Ford TM



43070
Glove Box Lid Strut Ford TM140 50N
OE Ref: 82014620

Ford TS/TM Cab Glass

42110

Glass Ford TL100 TL100A Rear Window TM110 115 120 150 155 165 175 190 TS100 110 115 120 TS90

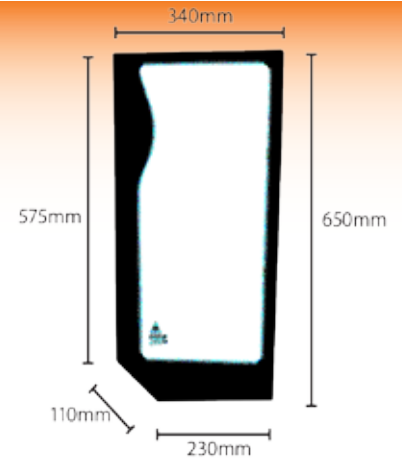
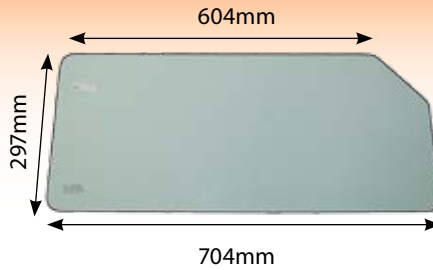

52453

Right Hand Glass Lower Front TM115 TM120 TM125 TM130 TM140 TM150 TM155 TM165 Case MXM120 140 155 175 190 M100 M115 M135 M160 8160 8260 8360 8560

OE Ref: 82001924

52454

Left Hand Glass Lower Front
OE Ref: 82001923

42887

Glass New Holland TD95D Case JX Series Rear

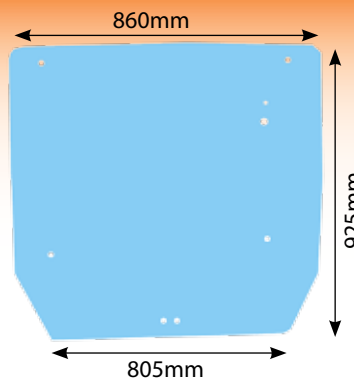

404666

Glass Ford 7840 TS TM M 6635 Rear - 11-95 60 Series 9 Hole Glass Blue Roof JXU
** Handle 402946 **

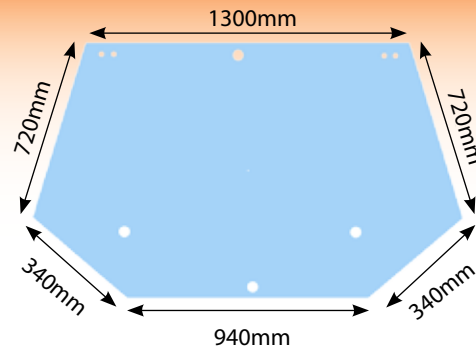

42079

Window Hinge T6 T7 TSA RH Rear



42095

Door Handle Ford TSA MXU

42080

Window Hinge T6 T7 TSA LH Rear

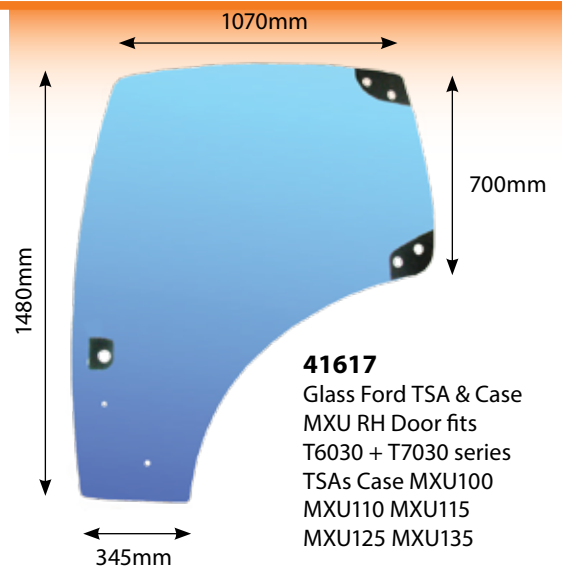

41617

Glass Ford TSA & Case MXU RH Door fits T6030 + T7030 series TSAs Case MXU100 MXU110 MXU115 MXU125 MXU135

Glass

40's Glass

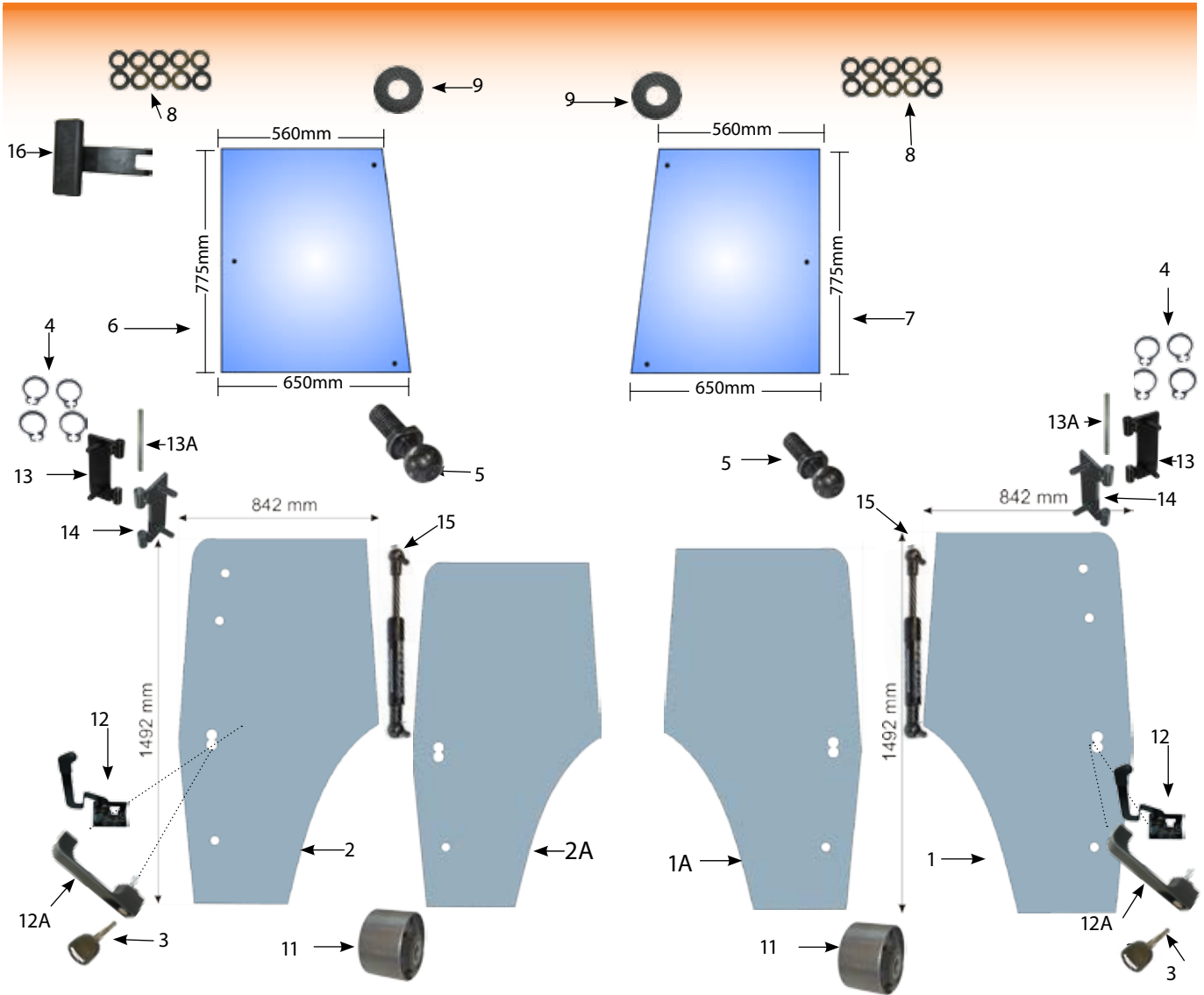

NOTE: HOW TO TELL THE DIFFERENCE BETWEEN CABS

11/91 - 11/95

12/95 -

White Roof
Carraro Axle
Light Dual Power

→ Blue Roof
→ Fiat Axle
→ Heavy Dual Power

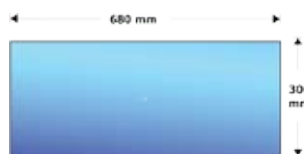
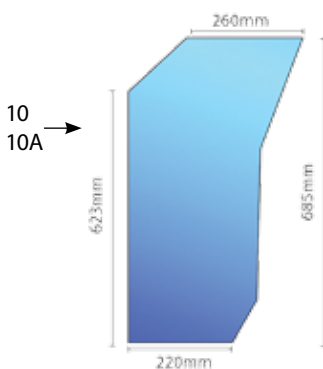

404735
Ford 40's Lower Rear Window



409902
Window Rubber Ford 40's Back

40's Glass

- | | | |
|------|---------------|---|
| 1. | 404762 | Glass Ford 40 Door RH 11-91/10-95 White Roof
44 Hole 5640 - 8340 8670 - 8970 White Roof - Early |
| 1A. | 404731 | Glass Ford 40 M TL Door RH 95-99 Blue Roof L 5640 - 8340 8160 - 8560 TS90 - TS115
Blue Roof Late 2 Hole TL70 - 100 M100 - M160 |
| 2. | 404763 | Glass Ford 40 Door LH 11-91/10-95 White Roof
4 Hole 5640 - 8340 8670 - 8970 White Roof - Early |
| 2A. | 404730 | Glass Ford 40 M TL Door LH 95-99 Blue Roof La
5640 - 8340 8160 - 8560 TS90 - TS115
Blue Roof Late 2 Hole TL70 - 100 M100 - M160 |
| 3. | 42077 | Ignition Key TM MXM TS TSA 40 60 TL JXU M Series T Series Ford |
| 4. | 41653 | Snap Ring Pin on Gear Lever & Door Ford
L 35 M T6000 TD TL TM TSA |
| 5. | 409787 | Ball End for Door Gas Strut Ford 40s Ford 35 40 60 M TM TS 40's
** TM 60s Door Strut is 41767 **
(TM 60s Door Strut is 41767) |
| 6. | 404732 | Glass Ford 40 TS TM 60 M Overwing LH 82009813 1/7/96 onwards |
| 7. | 404733 | Glass Ford 40 TS TM M 60 S Overwing RH
82009812 1/7/96 onwards |
| 8. | 409618 | Washer (Rubber) For Top of Back Window TL/TM |
| 9. | 41861 | Washer Ford 40s Rear Window Part of fitting kit for 402940 14 required to fit 402940 |
| 10. | D6716 | Glass Ford 40 Knee LH |
| 10A. | D6717 | Glass Ford 40 Knee RH |
| 11. | 409855 | Cab Mounting Ford 40 60 M TM TS - Rear back |
| 12. | 404888 | Door Latch Assembly Ford 7840 8340 LH
5640 6640 7740 8160 8240 8260 8360
M100 - 160 TL70 - 100 TS90 - 115 |
| 12A. | 42025 | Door Handle Outer Ford 40 Series Suits TL & TS 60 |
| 13. | 409766 | Door Hinge Ford 40 M TL TS RH (Pin is 42103) |
| 13A. | 42103 | Door Hinge Pin Ford 40 60 TM TS |
| 14. | 409788 | Door Hinge Ford 40's/M/TL/TS LH (Pin is 42103) |
| 15. | 41767 | Door Strut Ford New Holland TM / 60's* |
| 16. | 42886 | Window Handle Ford 40 60 Series TM Series JX1090U |

***Note:**

Check newton rating of existing gas strut before ordering a replacement.
Using a gas strut with a lower or higher newton rating can result in damage or glass breakage

Glass

Ford Super Q Rear Windscreen

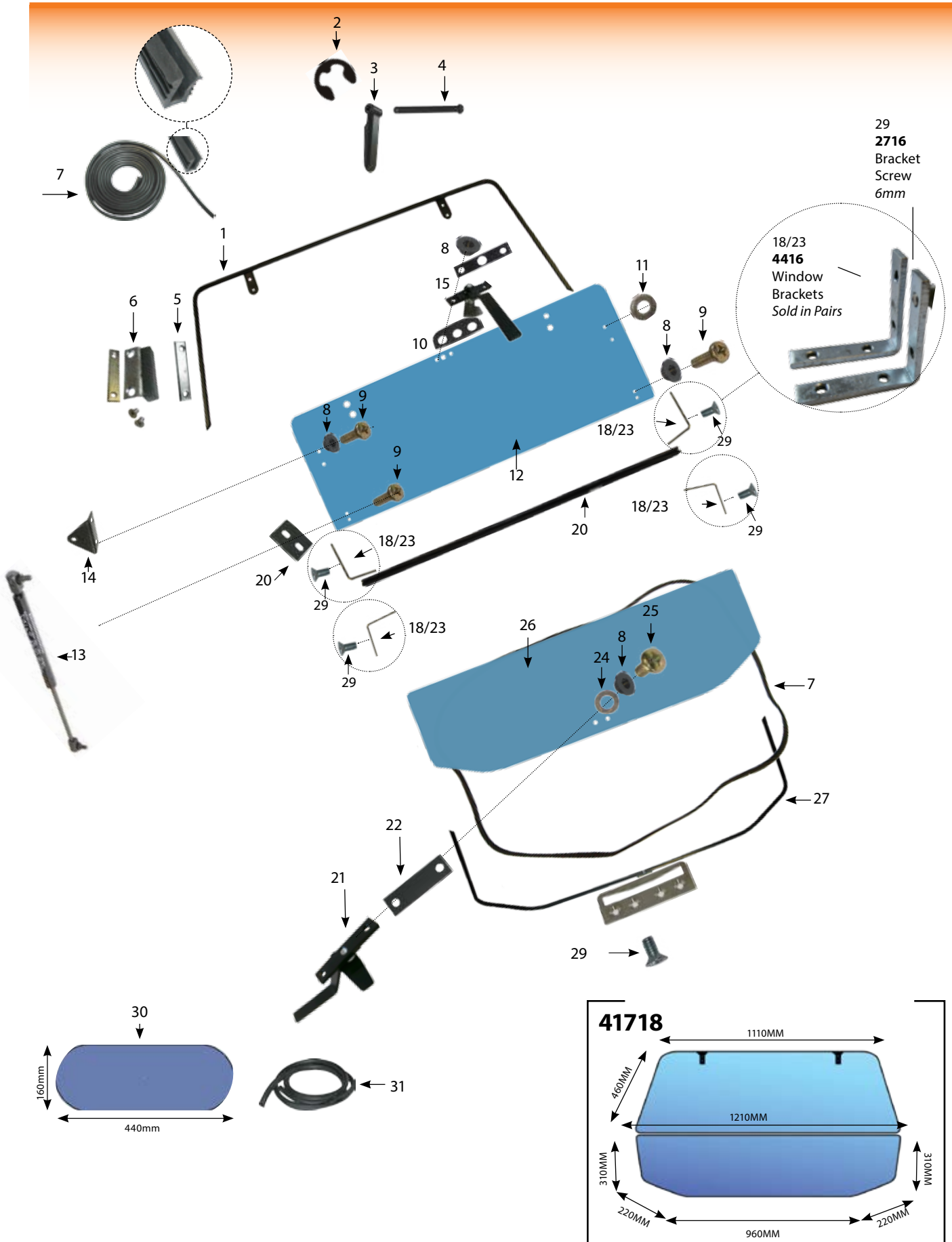

Ford Super Q Rear Windscreen

1	2827	Window Frame Ford Super Q Top Rear	
2	2190	Pick Up Hitch Lev Clip 7810 8210	2 required
3	4252	Hinge Ford Super Q Rear Lower	2 required
4	2184	Window Pin Super Q Rear	2 required
5	41721	Rear Window Rubber Stopper Inner Bracket	2 required
6	41720	Rear window Rubber Stopper Super Q & Q Cab	2 required
7	41731	Rubber U Ford Rear Window 11FT Length for one window	
8	2843	Window Bushing Ford Super Q Rear	10 required
9	41055	Window Screw Super Q Rear 4 required to fit 402940	8 required
10	2851	Window Pad Ford Super Q Rear	2 required
11	2842	Window Washer Ford Super Q Cab Rear	4 required
12	2409	Glass Ford Super Q Upper Rear Glass Tint	
13	2107	Gas Strut Ford S.Q Rear Window Length 375mm - Ram 150mm 160N ** Bracket is	2 required
14	2215	Bracket Gas Strut Super Q	2 required
15	2130	Latch Assembly Ford Super Q Top	
16	2131	Gasket for Super Q Latch Ass.	
17	2126	Latch Assembly Ford Super Q LH	
18	4416	Window Bracket Ford - PAIR	2 required
19	2849	Window Gasket Ford Super Q Rear	2 required
20	4243	Window Hinge Ford Q & Super Q Rear Centre	
21	2120	Latch Assembly Ford Super Q	
22	2854	Window Gasket Ford Super Q Rear	
23	4415	Window Bracket Ford Q Cab - PAIR	2 required
24	2844	Window Washer Ford Super Q Cab Rear	2 required
25	2848	Window Screw Ford Super Q Rear - Pan Head (M5 x 1 x 10)	2 required
26	4102	Glass Ford Q Cab Bottom Rear	
27	41723	Window Handle Frame Ford Super Q Cab Lower	
28	2716	Bracket Screw Ford Q Cab - 6mm	4 required
29	2716L	Bracket Screw Ford Super Q Cab - 8mm	
30	D6750	Glass Ford Super Q Bottom Rear	
31	1888	S Section Rubber - min sale 25mtr 50 mtr per roll	2 required

***Note:**

Check newton rating of existing gas strut before ordering a replacement.

Using a gas strut with a lower or higher newton rating can result in damage or glass breakage

Glass

40's Rear Window

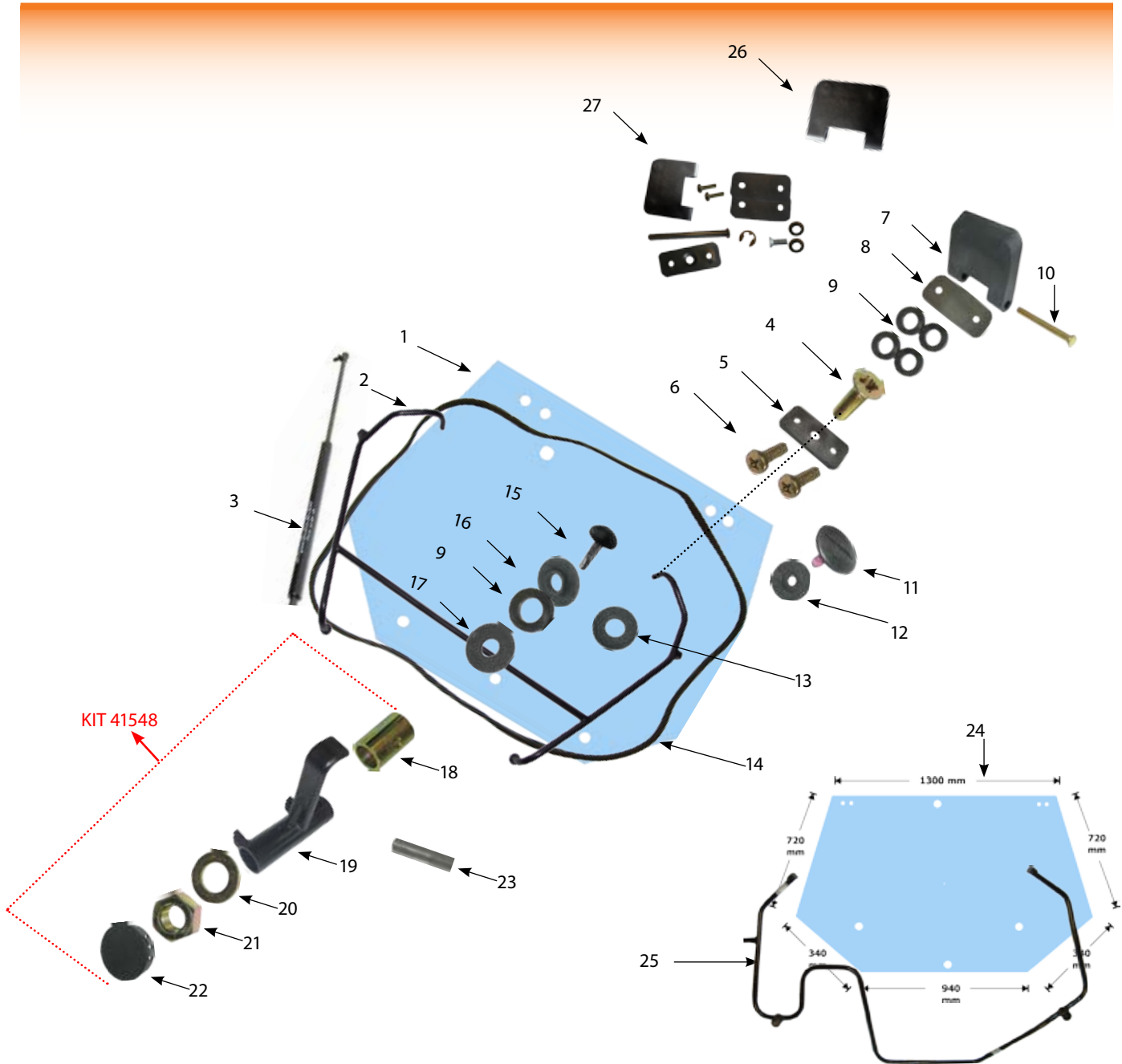

40's Rear Window

1	404665	Glass Ford 7840 Rear 8 Hole 11-91/6-94	
2	402940	Window Handle Frame Ford 40 Rear From 1991 - 1995 Later Version is 402946	
3	407119	Gas Strut Ford 40 Rear Window - <u>220N*</u>	
4	41836	Screw 40s Rear Window	
5	41834	Hinge Ford 40 Rear Window Part of fitting kit for 402940 2 required to fit 402940	
		** Used In Kit 43243	
6	41055	Window Screw Super Q Rear 4 required to fit 402940	
7	41839	Hinge Ford 40 Outer Rear Window Part of fitting kit for 402940 11/91 - 6/94	
8	41838	Seal 40s Rear Window Part of fitting kit for 402940	
9	409618	Washer (Rubber) For Top of Back Window TL/TM	
10	41650	Window Hinge Pin Ford 40 60 TM TS Rear & Side 2 required	
11	41859	Screw 40s Rear Window Part of fitting kit for 402940	
12	41860	Washer Ford 40s Rear Window Part of fitting kit for 402940	
13	41861	Washer Ford 40s Rear Window 14 required to fit 402940	
14	409902	Window Rubber Ford 40's Back	
15	409693	Window Screw Ford 40's TM TS TSA - Back	
16	409694	Washer Ford 40 TM TS TSA Back Window Small 2 required to fit 402940	
17	409695	Washer Ford 40 TM TS TSA Back Window Big	
18	409696	Spacer Ford 40 TM TSA TS on Handle Back	
19	409903	Window Handle 40/60/TM/TL/TS/M/70 Back21	
20	409623	Washer for Back Window Latch M12	Kit 41548
21	409624	Nut Back Window Latch Ford TS TM	
22	409698	Cap Ford 40 TM TSA TS for Back Window	
23	409697	Pin Ford 40 TM TSA TS For Handle Back Window	
24	404666	Glass Ford 7840 TS TM M 6635 Rear (11-95)	
25	402946	Window Handle Frame Ford 40 Rear - From 95 - **From 1995 Early Version is 402940**	
26	43240	Hinge New Holland 30 35 40 60 TTL TM TS Series Case JX MXM Series Fiat M100 M115 M135 M160 Rear Window OE Ref: 82000317	
27	43243	Window Hinge Rear Kit Ford New Holland 30 35 40 60 TTL TM TS Series Case JX MXM Series Fiat M100 M115 M135	

***Note:**

Check newton rating of existing gas strut before ordering a replacement.

Using a gas strut with a lower or higher newton rating can result in damage or glass breakage

Glass T6 T7

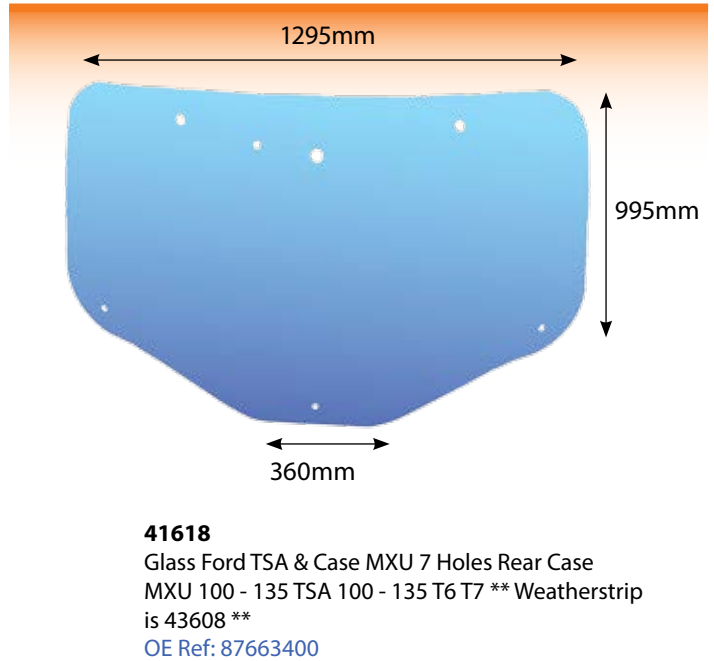
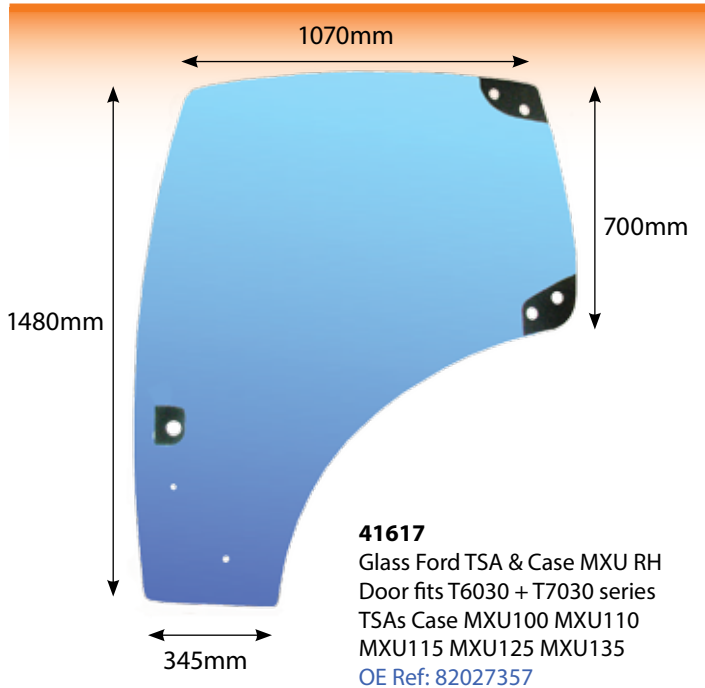



Date:.....

No. of Pages:.....

Name of the Rep.....

A/C Number:.....

From:.....

e-mail.....

Phone No.:.....

Fax No.:.....

Please quote for the following parts - Quotation Number :

I wish to confirm the following order on Quotation Number:

Please supply the following parts:

Please photocopy this page

Please do not remove this page

Qty	Part No.	Description	Unit Price
1.			
2.			
3.			
4.			
5.			
6.			
7.			
8.			
9.			
10.			
11.			
12.			
13.			
14.			
15.			
16.			
17.			
18.			
19.			
20.			
21.			
22.			
23.			
24.			

Comments:

Customer Signature:

Rep's Signature:

Tel No: + 353 44 934 1638

e-mail: info@qtponline.com, www.qtponline.com

Page of

Ford Super Q Cabs



42017
Cab Foam Kit Super Q



41951
Side Panel RH Ford Super Q Cab Series 10 Force II
*** IN KIT 42017 ***



41952
Side Panel LH Ford Super Q Cab Series 10 Force II
*** IN KIT 42017 ***

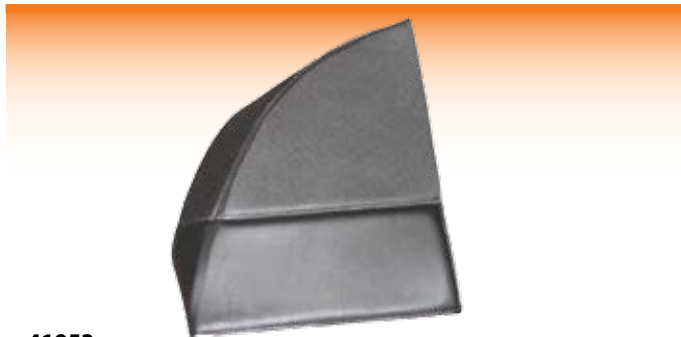

41953
Mudguard Foam Kit RH Ford Super Q Cab Series 10 Force II **Kit is 42017 **



41954
Mudguard Foam Kit LH Ford Super Q Cab Series 10 Force II * Kit is 42017 **



41801
Cab Foam Kit Ford 6610 - TW35 Suits Q Cab



41800
Headliner Ford 6610 - TW35 Suits Q Cab

Glass

All Rubbers Sold Per Metre

3097



Beaded Strip 500 - Per Mtr (1" or 25mm)
Beaded Strip 500's
(Per Mtr)

1773



Weather Strip Beaded (22mm)
4.8 mm Glass

1774



Filler Strip for 1773 3097 -
Sold in Mtrs.

1888



S Section Rubber - min sale 25mtr
50 mtr per roll

3984



Vinyl Edge Trim Sold per Metre For
From 0.7 - 2.5mm Glass / Panel

1285



Draught Excluder Rubber -
sold by the metre for 1 to 3
mm 50mtr Per Roll

51553



Filler Strip 20D Bubble Each
Side 10 Mtr Roll Dexta & Major
Bonnet

2548



Weather Strip 300 -
Per Metre

1407



Rubber Section 6mm Metre
for 3mm to 6mm

51554



Rubber 35 Dash Instrument Panel

51555



Filler Strip c/o Lip - 10 Mtr Roll

1427



Weather Strip Tool

51227



Glass Bonding Kit

51382



Rubber Section - Per Mtr

59723



Seal - John Deere 20 Series
Front Windscreen

53017



Body Filler Isocon
P38 Lightweight
250ml

53018



Fibre Glass Repair
Paste Isocon P40
250ml

53019



Fibre Glass Repair Kit
Fastglas

Vintage Head Lamps



41998
Head Lamp Fordson Dexta
Original Type



1734
Head Lamp Blue Ford Right Hand Plain Lens
12 Volt 45/40 Watt

1735
Head Lamp Blue Ford Left Hand Plain Lens
12 Volt 45/40 Watt



51503
Head Lamp Blue RH BPF 45/40W Tractor
logo

51504
Head Lamp Blue LH BPF 40/45W Tractor
Logo



51508
Head Lamp Blue Rim V/M Chrome
BPF40/45W



51506
Head Lamp Blue V/M - BPF
40/45W (Major)



51588
Head Lamp Black V/Mtg Plain
Lens BPF 40/45W



1140
Seal Beam Ford
4 1/4" 12v 40/40w Head Lamp - 3 Pin

53270
Seal Beam Rubber



1598
Seal Beam Size: 5 3/4" Volt: 12

53271
Seal Beam Rubber

Vintage Head Lamps



41853
Head Lamp Kit Ford 2000
3000 4000 5000
With Original Seal Beam
Unit, Heads & Dials



41687
Head Lamp Ford Seal Beam
Cup & Bracket Ford 1000
series, pre-Force



41688
Head Lamp Rubber For Ford Seal Beam Lamp

51511
Lens with
Tractor Logo



41161
Side Lamp Ford 6710-7710
White



41088
Head Lamp Side Mounted Ford
4610-7610 Blue



51507
Head Lamp 20D V/M Chrome Rim
Grey BPF 45/40W 51589 Blue -
51508 Blue - 51588 Black



51271
Head Lamp Black LH BPF
40/45W Plain Lens

51270
Head Lamp Black RH BPF
40/45W Plain Lens



51409
Head Lamp Black c/o H4 P45T
Bulb (With Grill)

Vintage Rear Lamps & Components



51510
Plough Lamp c/o Switch
Grey H3



51509
Plough Lamp White c/w H3 &
Switch David Brown



51960
Plough Lamp Black



41676
Rear Lamp Major 2 Pin Socket 12v



41676K
Rear Lamp & 2 Pin Socket c/w
Rubber Major



41727
Lamp Major Mudguard - PAIR

41959
Rubber For Rear
Lamp Major



Vintage Rear Lamps & Components



41888
Lamp Ford Blue Lollipop



3766
Lamp Black Lollipop



43122
Butler Lamp
Fordson Dexta **Pair**



41908
Reflector Fordson Dexta Original Type



41728
Tail Lamp Major LH & RH - Pair



41895
Indicator Side Lamp Ford 2000 Suits
Round Mudguard - Orange Lens



41749
Number Plate Lamp Dexta Black

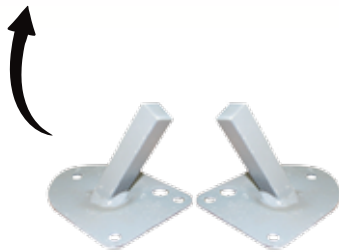

41756
Bracket Major To Hold Rear
Lamp - PAIR

51521
Lens Butler Rear Stop
Red



51520
Lens TE 20 Butler Rear
Stop White



51624
Rubber Seal for
TE/20D Butler Light



41806
Number Plate Lamp Dexta



41891
Number Plate Brackets Dexta

Head Lamps & Components



1999
Head Lamp Ford 6600



4282
10's L.H. Cowl

4281
10's R.H. Cowl



41554
Head Lamp Screw Kit
for Ford Lamp 46,66,76

41027
Head Lamp Ford
6610 c/o LH Cowl



41028
Head Lamp Ford
6610 c/o RH Cowl



1140
4" Seal Beam

1598
5 3/4" Seal Beam



409836 Ford 40's Head lamp



41138
Head Lamp Ford L TL 35



409644
Head Lamp Panel Ford 40 Front Bezel



42151
Head Lamp Ford TM115 - TM190 LH

42152
Head Lamp Ford TM115 - TM190 RH



42182
Surround Head Lamp Ford 60 M TM ** Complete Unit is
41420 **



41420
Head Lamp Assembly Ford 60 M TM ** 42182 is
Surround **

43298
Head Lamp Ford TS100 TS110 TS115
TS80 TS90 LH ** Top Grill is 409632 **
Kit is 43346 **
OE Ref: 82014420

43297
Head Lamp Ford TS100
TS110 TS115 TS80 TS90
RH OE Ref: 82014421



Head Lamps & Components



42203
Head Lamp Ford T7000
Series Only RH

42204
Head Lamp Ford T7000
Series Only LH

42907
Head Lamp TS100A TSA T5 T6 T7 TVT TLA
RIGHT HAND SIDE LEFT HAND DIP
OE Ref: 82029727

42908
Head Lamp TS100A TSA T5 T6 T7 TVT TLA
LEFT HAND SIDE LEFT HAND DIP
OE Ref: 82029728

43518
Head Lamp TS100A TSA T5 T6 T7 TVT TLA
LEFT HAND SIDE RIGHT HAND DIP
OE Ref: 82029729

43517
Head Lamp TS100A TSA T5 T6 T7 TVT TLA
RIGHT HAND SIDE RIGHT HAND DIP
OE Ref: 82029730



43503
Work Lamp New Holland T6 T7
T8 TSA TG Front
OE Ref: 82031075



41841
Bulb Ford TS100A Work Lamp
OE Ref: 44995162



43461
Work Lamp T6090 T6040 T6010 T6020
T6030 T6090 T6050 T6060 T6070 T6080
T7040 T7030 T7070 T7050 T7060 **Front
Left Hand**
OE Ref: 84138309



43459
Work Lamp Ford T6030 T6020
T6010 T6050 T6070 **Rear Roof
Right Hand**
OE Ref: 84254565

43460
Work Lamp **Rear Roof Left Hand**
OE Ref: 84254566



53742
Front Marker Lamp Right Hand Ford
T6 T7 TS Case CS CVX Maxxum Puma
Steyr Profi, 9000 Series
OE Ref: 87313173

53743
Front Marker Lamp Left Hand
OE Ref: 87378477

53744
Lens Front Marker Lamp
OE Ref: 87304539

Lamps



2089
Front Indicator Parking Lamp 200s 300s

84mm Long 84mm High 51mm Deep



409649
Lamp Ford 40 TS 90-100 on Front Rear
Mudguard 123mm x 81mm



1715
Front Marker Lamp 12v Flat PAIR
185mm Length x 67mm High x 50mm Deep

Single = 1037



1717
Front Marker Lamp 12v Tapered
185mm Length x 67mm High x 68mm Deep

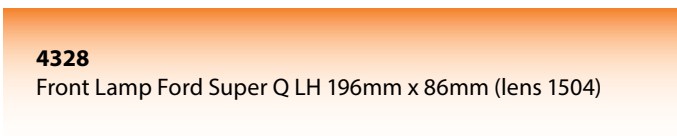

4328
Front Lamp Ford Super Q LH 196mm x 86mm (lens 1504)

4329
Front Lamp Ford Super Q RH 196mm x 86mm (lens 1504)



1504
Lens Amber And Clear To
Suit 4328 4329



41137
Front Lamp Ford AP LH RH
Lens 2391

170 x 90 x 95mm deep



2391
Lens Ford for 41137 4149
4150 Front Lamp



Lamps

7798

Combination Lamp New Holland Front RH TD s
120 x 80



4207

Signal Lamp Double Sided 80mm High 120mm Wide
80mm Deep ** Front Lens 2529 ** Rear Lens 53793 **



59799

Indicator Lamp Less Bulbs 77mm
Diameter 40mm Deep
Ford 2000 3000 4000 5000 7000 7100
7200



2529

Lens for 4207
OE Ref: 71316700



53793

Rear Lens For 4207

42127

Front Indicator Lamp LH MXM 35 Series TL TM TS

42128

Front Indicator Lamp RH MXM 35 Series TL TMTS



41663

Side Marker Lamp Ford 2000 - 7600 Front LH

41664

Side Marker Lamp Ford 2000 - 7600 Front RH



Rear Lights

41167

Rear Lamp Ford 1000
- Full Red Lens - PAIR



41494

Lens for 41167 Lamp



42882

Rear Lamp Ford 2000 - 7000 Pair



41413

Rear Lens Ford 5000 RH

41414

Rear Lens Ford 5000 LH



402913

Rear Lamp Ford 40's For White Roof
OE Ref: 81864736



4298

Rear Lamp Ford Super Q LH Lens 4308

4299

Rear Lamp Ford Super Q RH Lens 4308



4200

Rear Lamp Ford Q Cab -
PAIR Lens = 2390



4308

Lens Rear Lamp 184 x 76mm
OE Ref: 83952180



2390

Lens Ford for 4200 Rear Lamp



43535

Rear Lamp New Holland TLs Ford 35s
Case JXU LH & RH OE Ref: 82009066



51281
LH

Replacement Lamp for
New Holland TL TS
Ford 4340 5340

51280
RH



52850

Lens for 51280 & 51281



43021

Rear Lamp New Holland TD75 TD60
TD80 TD90



409643

Rear Lamp Ford 40 TM TS90-115

244mm x 70mm x 62mm Deep



409642

Rear Lamp Ford 40 TM TS90-115 (Start Year
95) ** Lift Switch is 41921 **

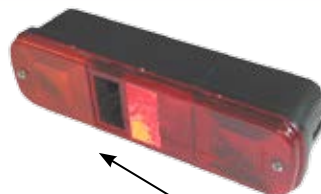

41921

Lift Control Switch External
Ford 40's 60's TM TS
T7030-T7060



43551

Rear Lamp RIGHT HAND T7000 T6000 T6
T7 Series OE Ref: 87747246



43552

Rear Lamp LEFT HAND OE Ref: 87747247

43561

Lens to suit
OE Ref: 87304535



Rear Lights

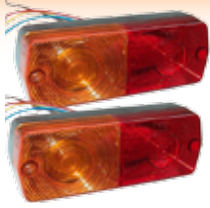

1759
Rear
Combination
Lamp 12v
Tapered PAIR



1716
Rear Combination Lamp
12v Flat PAIR 185mm x
67mm x 50mm



41782
Rear Lamp Ford
Mudguard - Black
Plastic



62651
Rear Lamp
Small Round



2416
Lens for 1759
Yellow & Red

Work Lamps

2324N
Work Lamp Cab H3 Single Mounted 6"
x 3.5" **NARROW BACK**



2324
Work Lamp Cab H3 Single Mounted
6"x3.5"
(24 in a box) 154mm Wide x 84mm
High



62750
Work Lamp Oval 54s 64s 74s
Also fits JCB



43061
Work Lamp Ford TD55 TD95



2356
Work Lamp Small Rubber Body 55 Watt bulb
125mm Diameter 76mm Deep



3179
Work Lamp H3 12V Square



4250
Work Lamp Side Mounted RH



4249
Work Lamp Side Mounted LH
Suits Ford Super Q Cab

Bulbs

H1



3102 12V h1 55w Bulb
3550 24V h1 55w Bulb

H3



1003 12V H3 55w Bulb
3678 24V H3 70w Bulb



1412
Bulb 12v 21w Indicator



4205
Bulb 12v 21/5w Stop/Rear
Old Type Ford Q Cab

H4



1111 Bulb 12v 60/55w
H4 Halogen

H4



4324 12V H4 80/100W Bulb
3909 12V h4 60/55W Bulb

H7



51715
Bulb H7 55W



1413
Bulb 12v 21/5w Stop & Tail



3586
Bulb 12v 5w Double
Contact S/F



4499
Bulb 12v 21w Double
Contact



1361 12V 5W Bulb
3160 24V 5W Bulb



1360
12V 40/50W Bulb



43090
Dash Lamp Bulb Ford
TM Series



1347 12V 4W Bulb
4509 12V 2W Bulb



1359 12 V 5W Bulb (38 Mm)

4657 12V 10W Bulb (30mm)



1971
Bulb Holder Single
Contact



1316
Bulb 12v 45/40W



3196
12V 3 W Bulb
4128
12V 1.2 W Bulb



41841
Bulb Ford TS100A
Work Lamp



59805
Bulb 12v 50w John Deere
6000 & Ford

Number Plate Lamps



4233
Number Plate Lamp Black (100mm)



3633
Small Number Plate Lamp (68mm) 300s



3700
Number Plate Lamp Black
Plastic Body 82mm

3701
Number Plate Lamp Black
Plastic 104mm



4844
Licence Plate Lamp
112mm

4234
Number Plate Lamp Chrome
(100mm)



4845
Licence Plate Lamp
82mm



4846
Number Plate Lamp
87mm

Interior Lights



1232
Small Interior Light -
116mm x 50mm







3487
Lamp Interior 200mm X 70mm



409638
Cab Light Ford 10 40
TM TS90-115 TW5 15
25 35

Lucas Beacons

<p>51320</p>  <p>Beacon 12V Magnetic c/w Bulb Lucas Type</p>	<p>51332</p>  <p>Beacon 12-80v Mini Xenon</p>	<p>59624</p>  <p>Beacon John Deere 12v Flexi Stem Small</p>	<p>51321</p>  <p>Beacon 12v Flexi Stem Lucas Type</p>	<p>53357</p>  <p>Beacon LED Flexi 12/24V</p>	<p>53358</p>  <p>** USE 53855 WHEN STOCK GONE **</p>
--	---	---	---	--	--

<p>43190K Beacon Work Lamp Bracket Kit Left Side</p> <p>Kit includes:</p> <ul style="list-style-type: none"> • Beacon Bracket Assembly • Work Lamp 8 LED 24W Flood 1920 Lumen • Flexi Beacon 	<p>53857 Beacon Kit</p> <p>Includes: Beacon, Bracket, Wiring, Fuse & Switch</p> 	<p>43592 Beacon Kit T6.120 - T6.175 T6010 - T6090 T7.170 OE Ref: 710762034</p> <p>Includes: Beacon, Cable Connections, Bolt Fixing Set, Beacon Pole, Brackets</p> 	<p>43628 Beacon 12/24V Pole Mounted New Holland T6 T7 TM TS OE Ref: 82018390</p> 
--	---	---	--

<p>51388 Beacon Bracket Spring Loaded</p> 	<p>51388B Bracket Angled for 51388 Beacon Bracket 42 43 61 62 81 82</p> 	<p>43190 Beacon Bracket Assembly Ford 5640 6640 7740 7840 8240 8340 LH</p> <p>43501 Beacon Bracket Assembly Ford 5640 6640 7740 7840 8240 8340 RH</p> 
--	--	--

<p>3686 Beacon Bracket</p> 	<p>51034 Beacon Bracket Adjustable</p> 	<p>3680 Beacon Plug</p> 	<p>51417 Beacon Bracket John Deere</p> 
---	---	---	---

<p>51422 Beacon Bracket</p> 	<p>51387 Beacon Bracket</p> 	<p>3687 Beacon Bracket</p> 	<p>51421 Beacon Bracket Adaptor</p> <p>Fits All</p> 
--	--	--	---

Electrical Components



- 41312** Rev Counter Cable Super Major (7/8 X 5/8) 58" Long - Early Version 41313
- 41311** Rev Counter Cable Super Major (50" 1270mm)
- 41313** Rev Counter Cable Super Major (5/8 X 5/8) 58" Long - Late Version 41312
- 41347** Rev Counter Cable Ford Major 58" Long 5/8 x 14mm 1473 mm Long
- 41310** Rev Counter Cable Dexta - 914mm



41354
Wiring Loom Major Super & Power

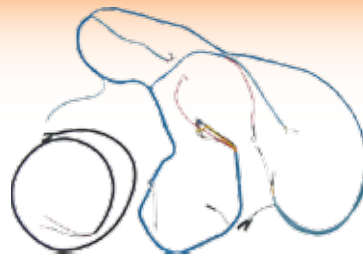

41353
Wiring Loom Major



41493
Gearbox Safety Switch Harness Ford
1000/600 2000 2600 2610 3000 3600
3610 4600 4610 5000 5110 5600 5610
5900 6410 6600 6610



3390
Wiring Loom Ford 5000 For
Dynamo Only

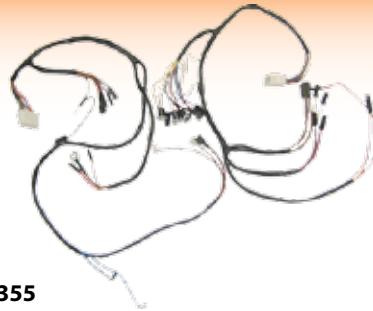

41355
Wiring Loom Ford 2000
3000 4000



41399
Battery Sensor Ford 7610



42280
Fuse Box Cover Ford 6610



41352
Wiring Loom Dexta Super
Dexta

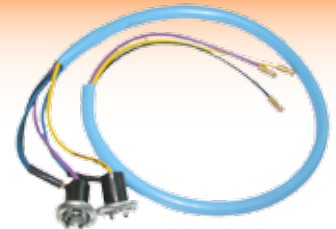

41813
Wiring Loom For Dexta Dash
Lamps ** 41822 are Dash
Lamps **

Electrical Components

Starters



41587
Starter Ford TS TM M 60 40 Genuine 4.2 kW All Fords from Ford 2000 to TW 35 Also Matbro Saunderson Muirhill County



41587R
Starter Ford TS TM M 60 40 - ISKRA 4.2 kW All Fords from Ford 2000 to TW 35



52480
Starter Gear Reduction New Holland TVT
OE Ref: 87751000



1948
Starter Ford & 35 4 Cylinder M50 RH FIT
Solenoid = 51222



42892
Starter TSA Case MXUlskra



43299
Starter T5 TLA TNA T5030 T5040 T5050 T5060 TL100A TL70A TL80A TL TN85A TN95A OE Ref:84208903



41682
Starter Dexta & 20D - Original Lever Type **RH Fit**



41680
Starter Major - Original Lever Type **1952 - 1964** LH Fit

1946
Solenoid 12v for Lever Type Starters Major Dexta IH OE Ref: 9843617



1108
Solenoid Push Button



61891
Dust Cover Major Starter



1833739
Starter Switch c/w Nut Fits Major, Dexta OE Ref: 1833739



63015
Bracke Major Starter Solenoid



62669
Shift Lever Dexta & Major Starter



Electrical Components



409910
Solenoid Switch Ford 40 4WD
- Fiat Axle



43659
Solenoid Switch Ford 40 4WD
Fiat Axle (**COIL ONLY**)
OE Ref: 81867440



2313
Solenoid Valve Ford 40
7610 7810 6410 4WD



43556
Temperature Sender Ford 3830
4030 4230 4430 8430 3435
3935 4135 5635 6635 7635
TL65 TL70 TL80 TL90 TL100
OE Ref: 4171667



401300
Solenoid Valve Ford 8340 SLE
4WD + Diff Lock



403130
Flasher Unit Ford 40 60 TL M (5 pin) 5640
6640 7740 7840 8340 8160 8260 8360
8560 TL 70 80 90 100



42049
Relay TS 90 100 110 Starter & Heater
Plug



41493
Gearbox Safety Switch Harness
Ford 1000/6002000 2600 2610
3000 3600 3610 4600 4610 5000
5110 5600 5610 5900 6410 6600
6610 6810 7000 7010 7100 7200
7600 7610 8010



1833740
Isolation Switch Gear Box
Ford 2000 3000 4000 5000
7000



43023
Switch 4WD New Holland TN95
TN55 TN60 TN95DA



43642
Light Control Panel New
Holland T6 T6000 T7 T7000
Series OE Ref: 47571855

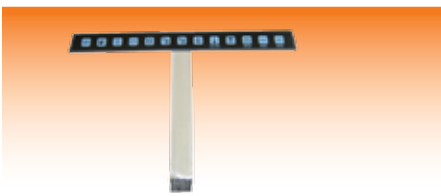

42060
Dash Strip Ford 40 4 & 6 Cylinder



41389
Heater Boot Seal Fordson
Dexta - 40 Seconds



42027
Heater Switch Fordson Dexta &
Super Dexta Cover 41389



41399
7610 Battery Sensor



41567
Battery Cover Lucas - Small
Original Type



41567B
Battery Cover Lucas - Big Type
Length 390mm

Electrical Components



409659
Brake Switch Hi/Low Forward / Reverse
Clutch SW - Depends on Model 30 40
60's Ford M TL TM TS



52268
Pressure Switch T7000 TM TS TS100A
TS115A T6030 Elite T6050 Elite T6070 Elite
T6080 PC T6080 RC



43662
Differential Lock Switch TS Series
OE Ref: 82013816



41657
Solenoid For Transmission TM M 60



43097
Solenoid Coil Gearbox TM120



409633
Shuttle Switch TLA TM TSA For/Rev
TS TL 60 Series M Series



409678
Potentiometer TLA TM TN TSA
Fits T Series



409705
Potentiometer
T & TM Series



42899
Switch Hand Brake T6 T7 TM TS
TSA 5 Wire



409726
Cable 40 Potentiometer Clutch &
Hydraulic



42912
Potentiometer c/o Loom 8770



43078
PTO Control Module TM140

PTO Switches



409677
PTO Switch **4 Pin Type**
TM115 TM120 TM125
TM130 TM135 TM140 TM150 TM155 TM16



43092
PTO Switch **4 Pin Type**
TM



43119
Switch Ford TM PTO Control Push
Button - **Mudguard Mounted**

Relays



43088
Relay 20Amp TM120 Roof Lamp 4 Pin



43093
Relay 40Amp TM Roof Lamp 4 Pin



43079
Relay Starter 5 Pin Ford T6s T7S TMs TSA



42255
Relay 40 TL TM TN TS 100 Amp



42048
Indicator Relay Double 40 Series TM TS

Speed Sensors



43691
Speed Sensor Transmission Housing 8970
8870 8770 8670 8770A 8870A 8970A 8670A
OE Ref: 86027316



43075
Speed Sensor New Holland TM150



43076
Speed Sensor Ford TM120 TM125 TM130
TM135 TM140 TM150 TM155 TM165

Oil Pressure Switches



42171
Oil Pressure Switch Dexta
Super Dexta



409655
Oil Pressure Switch
TS90-115 & TS100A-135A



409656
Oil Pressure Switch
40 Transmission - TS90-115



41858
Oil Pressure Switch TM TL TS
TSA Transmission



43089
Oil Pressure Switch TM120 Hydraulic

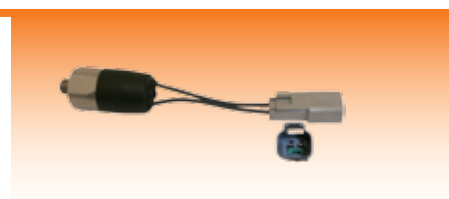

43065
Oil Pressure Switch Ford TM's
Powershift Transmission From Serial
Number D6249



43091
Oil Pressure Switch
Transmission TM T6000 T7000

Electrical Components

Alternators

2421P

Alternator 45 Amp c/o
Pulley & Fan



2148

Pulley for Alternator



2188

Alternator Fan Suits
2421 & 2421P



6760P

Alternator 300 12V 70amp
With Correct Pulley Also
Super Q 7610



41403

Alternator Ford 30 7910
8210 TW 72amp



41031

Alternator Ford 40 TS Series -
100amp 5640 6640 7740 7840
8240 8340 TS 80 90 110 115
TV140



41698

Alternator Ford TM 120 - 190
(120 amp) Also Fits M100
M115 M135 M160



MAHLE
Letrika



MAHLE
Letrika



43167

Alternator New Holland T6
T7 120amp Extra Wire



43168

Alternator New Holland
T6 T7 150amp 3 Lug



43169

Alternator New Holland
T6 T7 200amp



52483

Alternator
T7030 T7040 T7050 T7060 T7070
T7 235 220 250 260 230 245
[OE Ref: 87573243](#)

1012

Alternator 3
Pin Socket



Electrical Components

Cut Off Isolation Switches



3875E
Cut Off Isolation Switch Amp Heavy Duty
Max Peak Load 12/24V 2500A for 5
Seconds Max Continuous Load 12/24V
250A OE Ref: 1939387



3875
H/D Isolation Switch 24V 2500 amp
(Complete with chain)



51896
Key For Cut Off
Isolation Switch
Suits 3875

2923
Cut Off Isolation Switch -
Heavy Duty



2303
Lucas cut off switch



51984
Cut Off Isolation
Switch Battery
Emergency



Dynamos & Components

4992
Dynamo with Tacho Ford 11
Amp Dexta Super Dexta Major
Super Major
Pulley = 42028



42028
Pulley Dynamo Ford 2000
3000 4000 5000 7000
Dynamo=4992



41526
Angle Drive for Dynamo - Ford



43063
Gear Angle Drive Ford
Suits - 41526



Voltage Regulators



41666
Voltage Regulator Ford
Major 12v



1044
Ford 11amp
Voltage Regulator



43203
Voltage Regulator Dexta
Major Power Major Super
Dexta Super Major
OE Ref:81718302



41037
Voltage Regulator
Ford 10 30 TW

Gauges & Dash Parts

48813

Gauge Fordson N Oil Pressure - 50 Pound
Fordson 2N 8N 9N



51539

Temperature Sender Ford Case
John Deere



41760

Gauge Fordson Major Temperature



41758

Gauge Fordson Major
Ammeter



41759

Gauge Fordson Major Oil
Pressure



41665

Gauge Major Temperature -
White Face



41308

Rev Counter Clock Power /
Super Major Smith Type



53856

Bulb Holder Fordson Major **
Suits 41665 Gauge ** OE Ref:
E1ADDN10849



41307

Rev Counter Clock Dexta/Super
Dexta (AC Type)



36054C

Gauge Dexta Temperature With
Original Chrome Bezel



41902

Steering Column Rubber Power &
Super Major 58.6 x 44.5 mm (on the
Dash)



Gauges & Dash Parts

41487

Dash Instrument Panel Ford 2000 3000 4000 5000
Dynamo Driven ** Clockwise **

Gasket = 41530



41510

Dash Panel/Tach Ford 3610 4610 6610 7610
Anti-clockwise

Gasket = 41530



42939

Voltage Regulator Dash Ford
** Dash Panels are 41487 & 41510 **



42108

Dash Cover for Clock Ford 8360 6640
TL100A



41761

Angle Drive Major



4096

Temperature Sender Water
Ford 60 40 TM TW 26-
4600/5640-8560/L/M/TM/TW/
TS



3694

Temp Sender 2-7000



1704

Stop Lamp Switch Ford
3610 6610 Q cab



Gauges & Dash Parts

41600
Light Switch Fordson
(Key Hole) Narrow Body



41598
Lighting, Position Switch
Major -With Keyhole **
41599 is without Keyhole
**



41599
Light Switch Fordson
Major & Dexta No Key
Hole



1710
Flasher Unit &
Indicator Switch



42997
Flasher Unit New Holland
T6000 T7000 TL TLA TM
TN TNA TND TNDA TNF
TNFA TNS TNSA TNV
TNVA TSA



41726
Heater Plug Fordson Dexta
TEF 20



2666108
Heater Plug with Push On
Connection



2666103
Heater Plug Old Type 12v Screw Type



7200
Light Switch Fiat - 4 Way & Horn



43064
Switch New Holland
TM TS Indicator Lights



2704
Light Switch
Ford 4 Way



2703
Indicator Switch Ford 1000 series



Gauges & Dash Parts

1323
Ignition Switch Heat Start Alternator
Type 14



4498
Ignition Switch Ford 10's -
19mm 7 connections



43581
Ignition Key Ford 10
Series **Suits 4498 **



403977
Ignition Switch Ford 40 M TM TS TSA 60S T
** Key 42077 Replacement **



42077
Ignition Key Tm Mxm TS
TSA 40 60 TL JXU



403977R
Ignition Switch Ford 40 M TM TS TSA 60S
Oe Ref: 87561528



42993
Ignition Switch Ford 4635 4835 5635 6635
7635 Fiat L60 L65 L75 L85 L95 TL100 TL70
TL80 TL90 3 Position



42992
Ignition Switch Ford 4635 4835 4635 6635
7635 F100 F110 F115 F120 F130 F140 L60 L65
L75 L85 L95 4 Position



42994
Ignition Key For 42992
& 42993 Black



41386
Igniton Switch Key Super Major & 20D



Clutches, Transmission & PTO

Clutches

Dexta

42026
Clutch Disc
PTO Super
Dexta 29
Splines



41267
Clutch Super
Dexta (Dual) c/o
Main Disc & PTO
Pressure Plate &
PTO Disc & Main
Disc



2348
Seal Dexta Spigot
Shaft - Single Clutch
28.5 x 55.5 x 12.4mm



3775
Clutch Disc Dexta / Super
Dexta 9" Main Drive 1" x
15 Splines Main Drive



Note Comes as part of 41267

Major Super Major

4106
Clutch Disc Fordson
Super Major 12" Main



4911
Clutch Disc New Holland
Combine 11" ***Major,
Super Major*** 11" x 1
3/8" 10 Spli



4910
Clutch Assembly Dexta
Major Single Clutch
As Fits New Holland
Combine

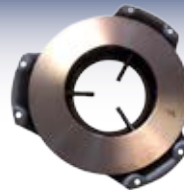

41668
Clutch Assembly Fordson
Major

Clutch Release Bearing = 1622

828123
Spigot Shaft
Bearing (All
Models)



41234
Lever Kit Fordson /
Fordson Super Major
(Without Springs)



2000/3000

3216
Clutch Disc Ford 4000 4600
11" 10 Spl & Spring



1153
Clutch Disc Ford 2000 3000 15
Spline 11" Organic



1878
Clutch Assembly Ford 2000
3000



41885
PTO Disc Ford 2000 3000 Dual
Disc

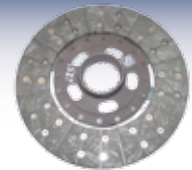

Clutch Aligning Tool = 43121

3086
Single Clutch Release
Bearing Ford 2000 3000 ID
52.5mm OD 90mm Inner
Width 20mm



3569
Clutch Release Bearing
KOYO Dual



828123
Spigot Shaft
Bearing
(All Models)



4870
Release Bearing Carrier Ford 2000



3900
Release Bearing
Carrier Ford 6610
80mm



43301
Carrier Release Bearing
Ford 5110 5610 6410
6610 6710 6810 7610 7710
5600 5700 6600 7600 Hub
Length: 82mm • I/D: 52.2mm •
Twin lugs •
OE Ref: D4NN7548A



Clutches

4000/4600



3216
Clutch Disc Ford 4000 4600
11" 10 Spl & Spring (Popular)



3345BB
Clutch Assembly Ford 4000
11" New Makes kit 2782

Clutch Aligning Tool = 43121



1980
Clutch Disc Ford 2000 3000
4000 15 Spline 11" & Springs
- Early



4592
Clutch Assembly Ford 4000 11" 29 Spline
Hub, 3 Lever OE Ref: D8NN7563DBRM

Clutch Aligning Tool = 43121



3315
Clutch Disc Ford 4000 4600 13"
10 Spl Organic

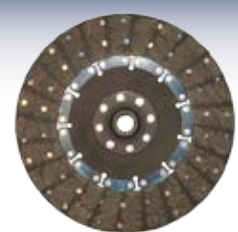

3042
Clutch Disc Ford 13" 15 Splined
Organic



64456
Clutch Assembly Ford 5030 13"
Diaphragm With Synchro Gearbox
OE Ref: 82013944



49004
Clutch Assembly Ford 5030 13" Diaphragm
Non Synchro Transmission only



2937
Clutch Assembly Ford 4600 - 13"
Synchro Transmission only

Clutch Aligning Tool = 43121

Clutch Kits 4000/4600

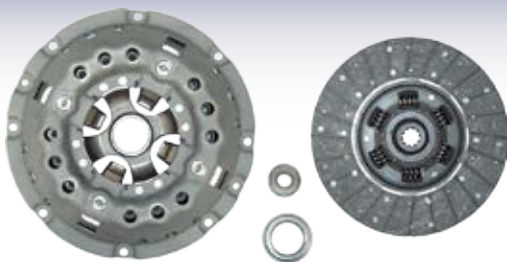

2782
Clutch Kit Ford 4000 4600 11" 10 Spl



3345BB
4000 11" B&B
New Cover Ass.



3216
4000 11" Disc
10 spd + Spring



1680
FLT Clutch
Release
Bearing



828123
Spigot
Shaft
Bearing

Clutches, Transmission & PTO

Clutches

5000/6600 12"



2024
Clutch Disc Ford Dual Power 10
Spline 12"



3372
Clutch Disc Ford 5000 6600 12" 12" x 1
5/8" 25 Splines Non Dual Power



3373N
Clutch Assembly Ford 5000 6600
12". Kit No. 2783 / 2784

1680
Clutch Release
Bearing FLT



828123
5000/6600 Dual
Power Spigot Shaft
Bearing



3341
Spigot Shaft
Bearing Ford



Clutch Kits

5000/6600 - Non Dual Power



2783
Clutch Kit Ford 5000 6600 12" NDP



3373N
Ford 5/6600 12" Cover
Ass.



3372
Ford 5/6600 NDP
12" Rigid Disc



3341
Ford
Spigot
Shaft
Bearing



1680
FLT
Clutch
Release
Bearing

5000/6600 - Dual Power



2784
Clutch Kit Ford 5000 6600 12" DP



3373N
Ford 5/6600 12" Cover
Ass.

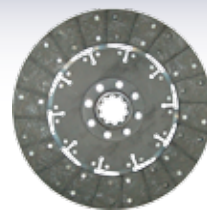

2024
Clutch Disc Ford
Dual Power 10
Spline 12"



3341
Ford
Spigot
Shaft
Bearing



1680
FLT
Clutch
Release
Bearing

Clutches

76/7610



42052
** USE 4111BB **



4111BB
Clutch Disc Ford 6600 7600 13" 10 Splined



43246
Clutch Assembly Ford 7600 7610 7810 13" Diaphragm
OE Ref: 82006046



3255BN
Clutch Assembly Ford 13"



3374
Clutch Disc Ford 13" 25 Spline



2938
Flywheel Ford 7600 7610 13"

2017
Clutch Disc Ford 10 Spline 13"
No Spring



2027
Clutch Disc Ford 7810 8200 10 Spline 13"



Clutch Kits 76/7610

43492
Clutch Kit Ford 5000 5100 5100
5200 5340 5550 5600 5610 5700
6410 6600 6610 6700 6710 6810
7000 7010 7100 7200 7600 7610
7700 7710 7810
OE Ref: 5247553

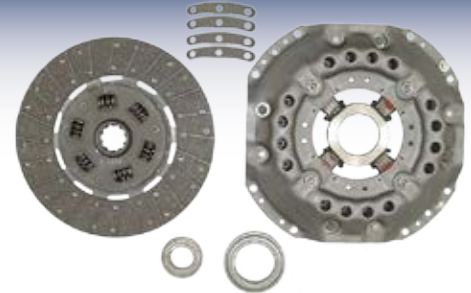

2788
Clutch Kit Ford 7600 7610 13" DP c/o Shims

- 3255BN**- Brand New Ford 13" Cover Ass
- 4111BB** - 66/7600 13" Dp Spd. Disc (B&B)
- 3341** - Ford Spigot Shaft Bearing
- 1680** - Flt Clutch Release Bearing
- 41963** - Clutch Shim Ford 7600 7610 (Set Of 4)



2785
Clutch Kit Ford 7600 7610 13" NDP



- 3255BN** - Ford 13" Cover Assembly
- 3374** - Ford 13" 25 Spline Ndp Disc
- 3341** - Ford Spigot Shaft Bearing
- 1680** - Flt Clutch Release Bearing

Clutches, Transmission & PTO

Clutches

7810/8400/8210/TW5 13"



402726
Clutch Disc Ford 7840 13"
Bronze



4111BB
7810/8210 13" 10 Spline Sprung
Disc Dual Power



3374
7810/8210 13" 25 Spline Sprung
Disc Non Dual Power



2027
Clutch Disc Ford 7810 8200
10 Spline 13" 6 Paddle



2017
7810/8210 13"
10 Spline Non Sprung Disc
Dual Power



8210

4197
8210 13" Clutch Kit Dual Power

2027 - 7810/8200 13" Spl. 6 Paddle Disc
3341 - Ford Spigot Shaft Bearing
3569 - Koyo Clutch Release Bearing

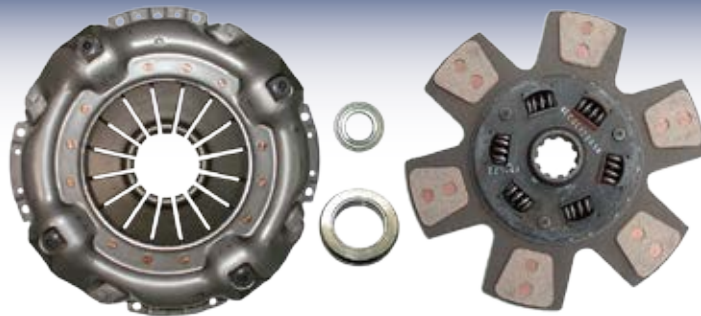

TW Series 14"



4131
Clutch Assembly Ford TW15-35 14" Single
Cover

4141G
Clutch Disc Ford TW15
20 25 30 35 Main Disc

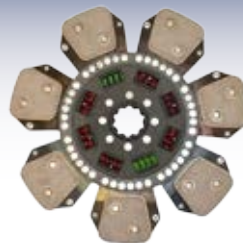

Muirhill 14"



3705
Clutch Disc Ford County /
Muirhill 14" Organic Non
Dual Power



41013
Clutch Release Bearing Ford
8630 8830 TW15-35



3341
Spigot Shaft
Bearing Ford

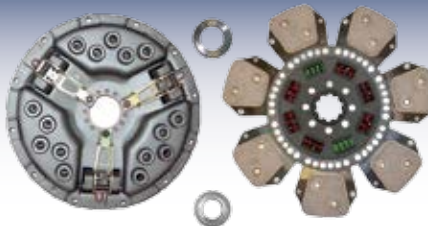

42138
Clutch Kit Ford TW15-35 14"

Clutches TS/40 13"



402724
Clutch Assembly Ford 7840 13"
Now Cover Ass. & Disc Sold in Kit
42082

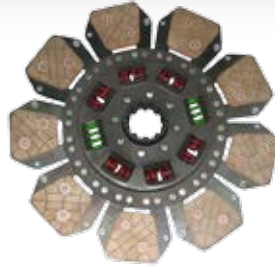

402726
Ford 7840 13" Disc
Bronze 10 Spl.

43491
Clutch Kit Ford 40 Series - TS Series Bronze Disc
** includes 404714 Release Bearing** 41957 kit
includes Organic Disc ** [OE Ref: 87689672](#)

Includes LuK
Bearings



41957
Clutch Kit Ford 40 Series - New Holland TS Series
Complete - Organic Disc [OE Ref: 87689672](#)

Includes LuK
Bearings



3341
Spigot Shaft
Bearing Ford



42052
Clutch Disc Ford
40S 13" Organic Disc
10 Splined 6600 7600



404714
Clutch Release Bearing Ford 7840 T6010 T6020

42082
Clutch Kit Ford 7840 10S
13" Organic Disc & C

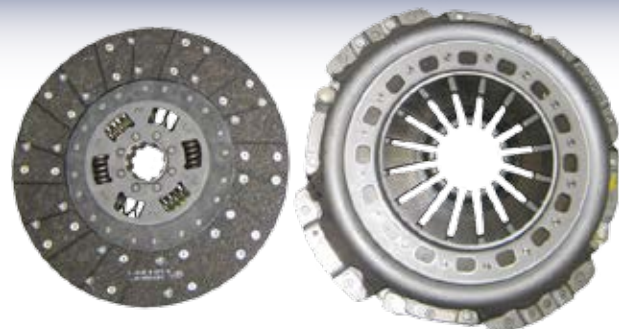

Clutches, Transmission & PTO

Clutches

35 TL L F 60 TM TSA T

41268

Clutch Assembly Ford 35 - Single 12" Fits 4635 4835
5635 6635 7635 TL100 TL100 A TL70 TL80 TL90
OE Ref: 5167939



41269 - Clutch Disc Ford 35 TL 6635 Main Drive

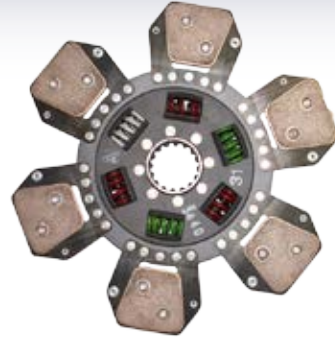

43193

Synchroniser Assembly Ford 4230
4430 4635 4835 5635 6635 7635 L60
L65 L75 L85 L95 TD TLTLA Series Fiat
62-86F 72-80F 82-86F 65-90
OE Ref: 5186629



TS/TM Clutches

42969

Clutch Assembly New Holland T6010 20 30 50 TS100A 110A
115A Maxxum 115 125 MXU115
OE Ref: 5196057



42970

Clutch Disc
New Holland T6010 20 30 50 TS100A 110A 115A
OE Ref: 5196055



41382

Clutch Kit Fiat M115 & M100 DT F 13"

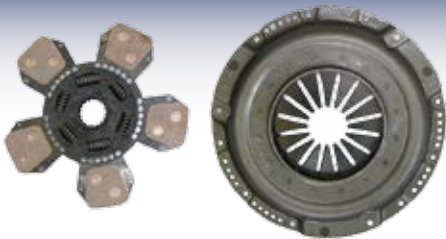

41843

Clutch Kit Fiat 13" F100-120/60's TM115-140
8160/8260/M100-115 TM115-140

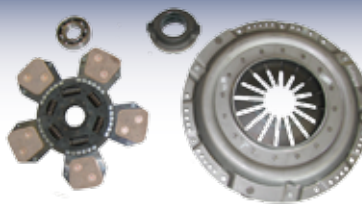

41306

Clutch Release
Bearing Fiat F100-
140 60 M TM TM115-
TM140 M100-135
8160 8260 8360

41842

Clutch Kit Ford TM Heavy Duty 14"

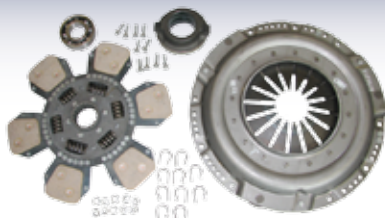

Clutches

35 TL L F 60 TM TSA T

Includes LuK Bearings

43495

CLUTCH KIT New Holland T4020
4030 4040 V F N with Power Shuttle Dual
Command Transmission
OE Ref: 370.0060010

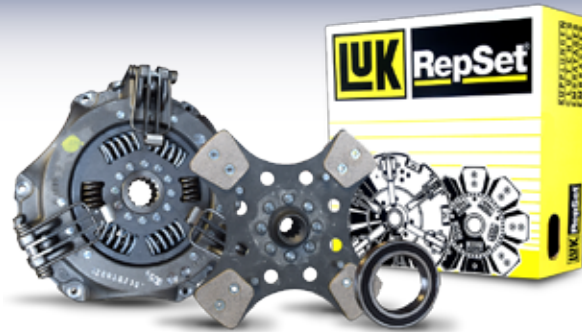

With Bearings

43490

CLUTCH KIT New Holland T50s TLs 35s Ls Case JXs JXUs
OE Ref: 5167935

Includes LuK Bearings



Without Bearings

41798

Clutch Assembly
New Holland TL 35 TLA Case JXU Dual Fits JX TD 310 Dual
OE Ref: 9973687



43489

CLUTCH DISC

New Holland T4.65 Powerstar T4.75 Powerstar
OE Ref: 84233500



60152RS
Clutch Release
Bearing Fiat Large



7014
Clutch Release
Bearing Fiat 100-90
50 x 80 x 22



63032RS
Bearing

43670

Clutch Kit TD80D TD90D TD90D OE Ref: 5097927, 84177326

Includes LuK Bearings



43493

PTO DISC

New Holland TN's 60's
OE Ref: 5176450



Clutches, Transmission & PTO

Clutches Dampers



404892L

Clutch Damper Ford 40 New Holland TS
OE Ref: [82008857](#)



52231

Clutch Plate New Holland TS100 TS100A TS110 TS110A TS115 TS115A Case IH MXM100 MXM115 24 x 24 Transmission OE Ref: [370.0060010](#)



42971

Clutch Damper Ford 4835 5635 6630 6635 7635 L95 New Holland TL70 TL80 TL90 TL100 Case JX70U JX80U JX90U JX100U OE Ref: [5181872](#)



43469

Clutch Damper New Holland TS115 TS115A TS125 TS125A TS135 TS135A Case MXM115 MXM125 MXM135 OE Ref: [47127699](#)



43470

Clutch Damper New Holland TS100 TS100A TS110 TS110A Case MXM100 MXM110 OE Ref: [47127700](#)



42972

Clutch Damper New Holland T5030 T5040 T5050 T5060 TL80A TL90A TL100A Powershift Transmission OE Ref: [87527552](#)

Damper TM's

41036

Clutch Damper Ford 8160 - 8560 Range Command Fits 8160 8260 8360 8560 M TM OE Ref: [5187845](#)

NEW DESIGN



41863

Clutch Damper New Holland TM 130 - 155 135 140 150 165 175 190 Full Powershift T6030 T6050 T6070 T6080 T7030 T7040 T7050 T7060 OE Ref: [5185207](#)



Clutch Parts

Clutch Master & Slave Cylinders

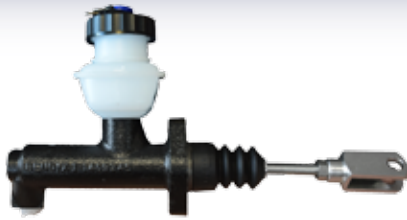

7783
Clutch Master Cylinder Fiat F 110-135 Ford 60 Bottle DOT3 Fluid



7784
Clutch Master Cylinder Fiat 115-180/90 F Also fits Ford TM 30 - Reservoir Bottle



7785
Clutch Slave Cylinder Fiat 115-180/90 Ford TM120

43051
Seal Kit Clutch Slave Cylinder Ford TM120 Fiat 115-180/90 ** Seal Kit For 7785 **



409825
Clutch Master Cylinder Ford 40 TS - LHM Fluid 5640 6640 7740 7840 8240 8340 TS100 TS100 A TS110 TS110 A

41010
Repair Kit Ford 40 TS Clutch Master Cylinder 5640 6640 7740 7840 8240 8340 TS100 TS110 TS115 TS120 TS90



43032
Clutch Master Cylinder Ford TM130 TM140 TM120 TM125 8360 8160 8260 LHM Fluid



43342
Clutch Master Cylinder Ford TM130 8360 TM140 TM120 TM115 8160 TM125 8260
OE Ref: 82008704

Clutches, Transmission & PTO

Clutch Parts

Clutch Cables

41048

Clutch Cable Ford 4630 4830 5030 3430 3930



409794

Clutch Cable Ford 40 TS



41087

Clutch Cable Ford 35 L TL



43677

Clutch Cable New Holland T5 - TLA

OE Ref: [82016868](#)



Clutch Springs



409729

Clutch Pedal Return
Spring Ford 40 TS



43123

Spring Clutch Pedal Ford
TM120 TM135 TM155 TM165
TM190



43623

Spring Clutch Pedal
T6/ T6000/ T7 /T7000 Series
OE Ref: [84561533](#)



LHM

2448

Brake Hydraulic Oil 1Ltr
LHM Mineral

Potentiometers



409678

Potentiometer Ford TLA TM
TN TSA Fits T Series For Clutch
/ Front Axle



409705

Potentiometer Ford T & TM
Series



41657

Solenoid For Transmission
Ford TM M 60



43097

Solenoid Coil Ford Gearbox
TM120



409726

Cable Ford 40 Potentiometer



42912

Potentiometer c/o Loom
Ford 30 40 TS TM

Gearbox Parts

 <p>41938 Gear Box Sensor 60 Series TM</p>	 <p>3654 Selector Fork 2/6th & Rev Ford Genuine is 3654G Arm is 3121</p>	 <p>3121 Reverse 2nd & 6th Selector Fork Arm Ford</p>	
 <p>4134 Gear Lever Spring Ford</p>	 <p>41151 Selector Rail Dowel Ford Dexta</p>	 <p>1257 Selector Fork Ware Pin Ford 5600 7610</p>	
<p>1176 5000 Centre Housing Gasket</p> 		<p>41001 Centre Housing Gasket Ford 2000 3000 4000 460</p>	
 <p>41375 Ford 1000/600's Gear Lever Dust Cover</p>	 <p>42088 Gear Stick Boot Ford 7840 Kit is 42207</p>	 <p>42208 Console Plastic Gear Boot Ford 7840 Kit is 42207</p>	 <p>42207 Gear Stick Boot & Plastic Console Ford 7840</p>
 <p>41365 Clutch Pedal Ford 5000 6600</p>	 <p>41534 Washer for Gearbox Ford 2000-7000 (42.38mm) also dexta</p>		
 <p>2081 Bush Ford 10s Gear Shift Shaft SQ Cab 85-</p>	 <p>2086 Bush Ford 10s Gear Shift Shaft Q Cab 85-</p>	 <p>42904 Bush Clutch Shaft To Gearbox Housing Ford 600 Series 1000 Series TW Series</p>	 <p>2080 Gear Shift Shaft Ford 10 Super Q Cab 168mm (6 5/8") From Year 85</p>

Gearbox Parts



1750P
Gearbox Lid Ford 2000 3000 3600 c/o
Levers 4000 - 4600 PRESSED VERSION
1750 is Cast



1406
Gear Box Lid Gasket
Ford
4000 4600



3245
5000 Gearbox
Lid Gasket



41516
Gearbox Lid c/o
Levers Ford 5000



4140
Gear Lever Knob
Ford High/Low



4133
Gear Lever Knob
Ford - Main



51597
Gear Lever
Knob
Super
Major



41755
Gear Lever Dexta Hi/Low



41525
Gear Lever Retainer
Ford 3000 3600 3610



42071
Gear Box
Cover
Major



4133
Gear Lever
Knob Ford -
Main



4140
Gear Lever Knob
Ford High/Low



43555
Transmission Rail Set Ford Dexta
OE Ref: 957E7240



41932
Gasket Set Transmission
Fordson Dexta Fordson
Super Dexta



41786
Gear Box Cover Dexta
42046 Is Cover c/o Levers



42046
Gear Box Cover Dexta c/o Levers
41786 Is The Cover

4000 Transmission (8 Speed)

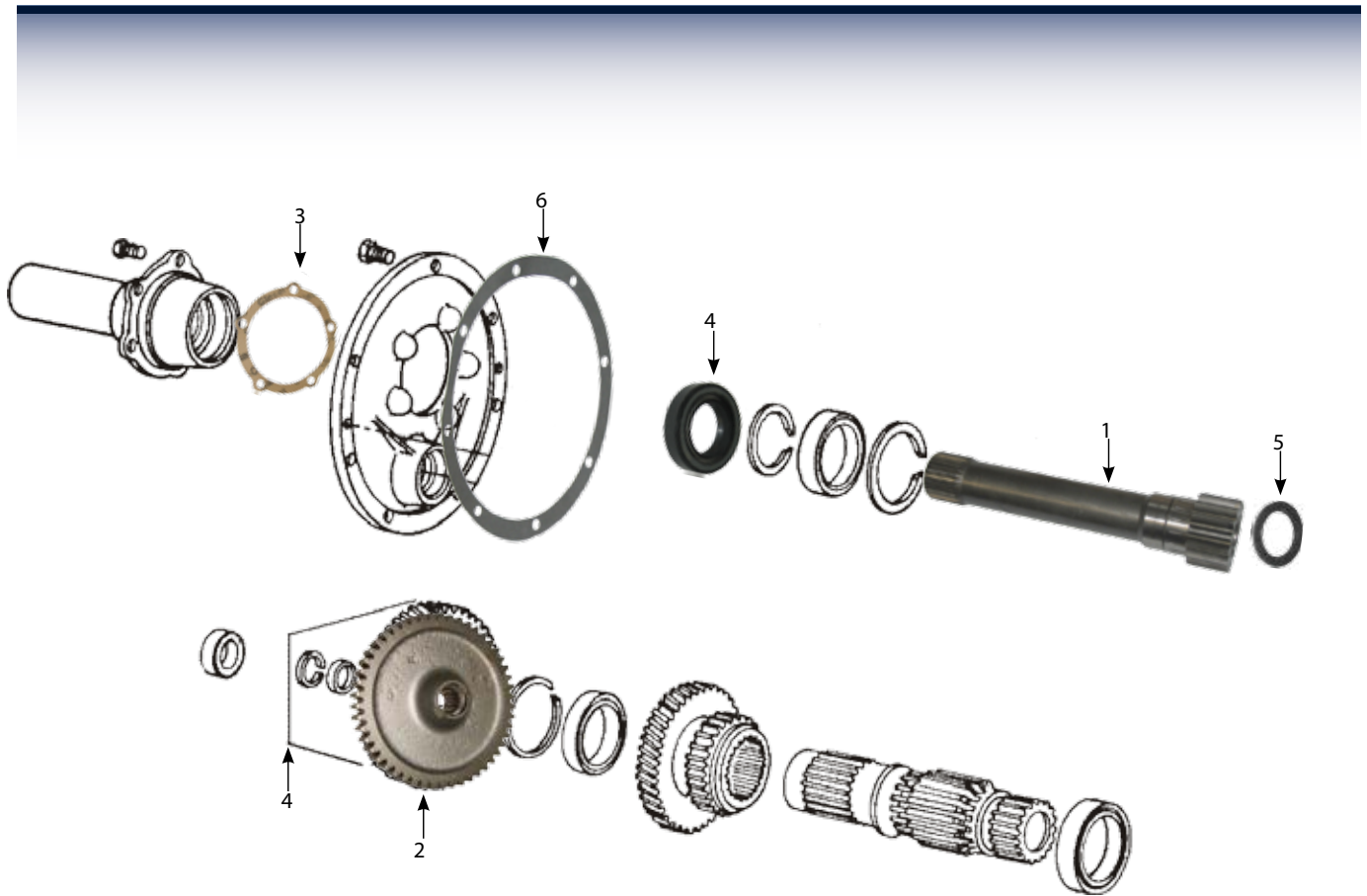

1. **4447** PTO Input Shaft Ford 4600 - Late 4000 15T
2. **4520** PTO Center Shaft Gear Assembly Ford 5000 (50T)
3. **1524** Ford Gasket Input Housing
4. **4099** PTO Input Seal Ford 4000 Spigot Shaft Seal For Dual Clutch Dexta
5. **1501** PTO Input Seal Ford 2600 3600 4600 38.25x26x6.5
6. **3802** Gasket Ford 5600 7700 Cover - Dual Power

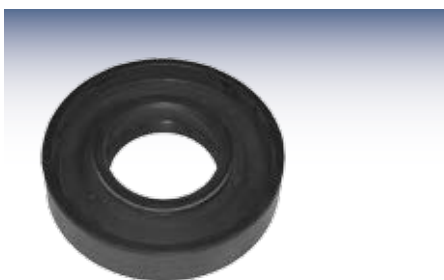

41485
Transmission Seal Super Major
89x42x15.5



41447
Input Shaft Seal Super Major

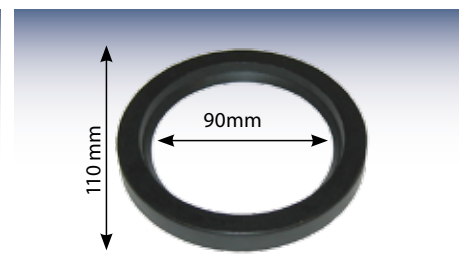

41448
Input Shaft Seal Super Major Large 85
x 111 x 12.5mm

5/6600 Transmission

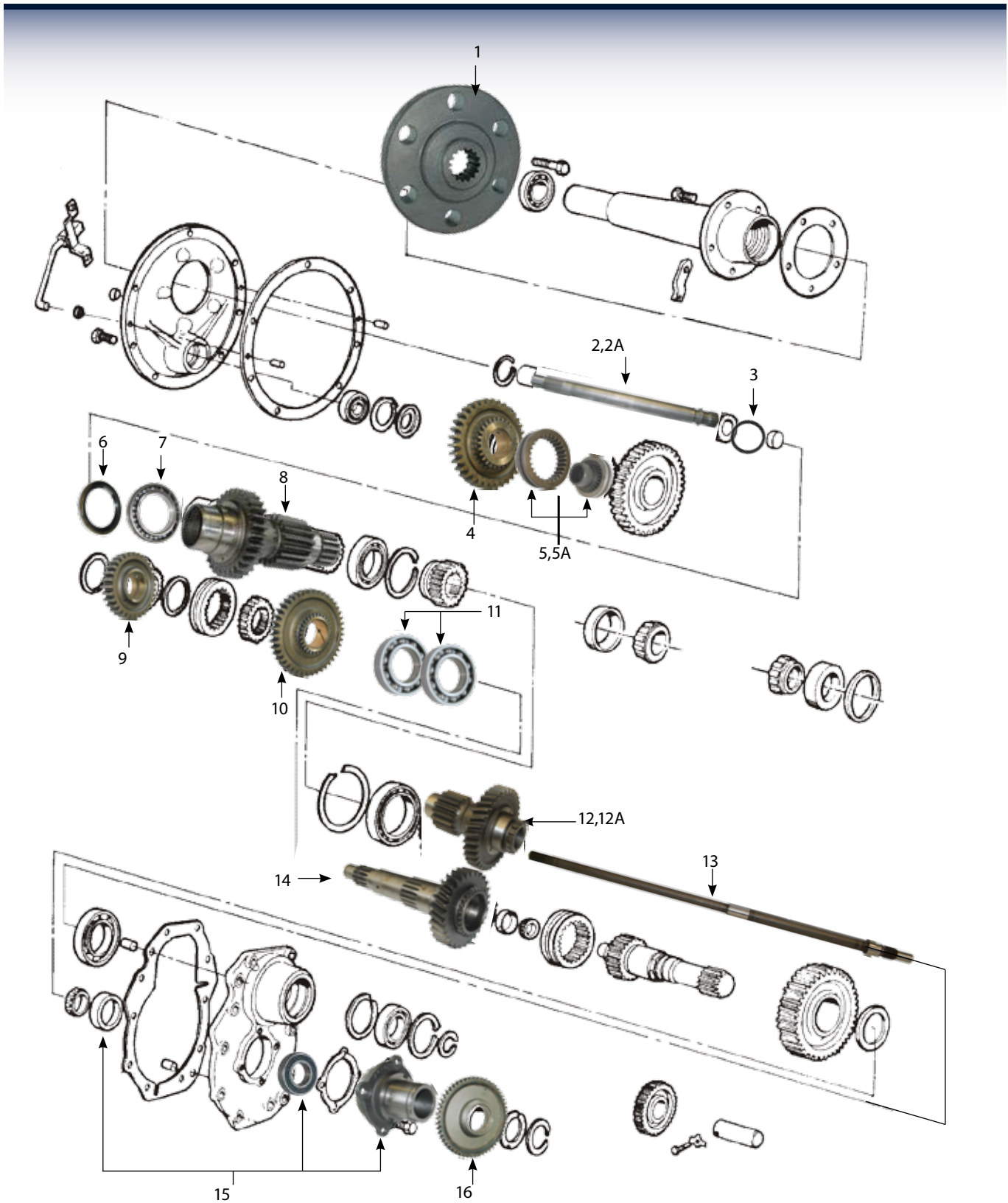



5/6600 Transmission

- | | | |
|------|------------------|---|
| 1. | 4293 | PTO Hub Ford 15 Spline Old Type |
| 1. | 3342 | PTO Shaft Hub Ford 20 Splined 2 - 7000 4600 - 7600 5610-8210 6640-8240 TS90-110 6 Holes |
| 2. | 4433 | Input Shaft Ford 5000 6600 NDP Main Drive 20T 490mm |
| 2A. | 4646 | Main Input Shaft Ford 5000 6000 - 20 Teeth |
| 3. | 4061 | PTO Input Shaft Seal Ford 5600 7840 TW TS Non Dual Power 12/12 Transmission |
| 4. | 4440 | Gear Ford 6600 Third 35/28T Fits 2810 2910 3230 3900 3910 3930 4100 |
| 5. | 4437 | Gear Shaft Ford 5600 6600 Slide Sleeve 28T |
| 5. | 4438 | Gear Ford 5600 6600 Front & Sleeve 28sp |
| 5. | 4445 | Gear Shift 4600 - 7600 Slide Sleeve 28 Teeth |
| 5A. | 4637 | Top Shaft Coupling Ford 56/6600 29T |
| 6. | 4100 | Input Shaft Seal Ford TS 40 6610 - 7810 5000 6000 60 x 80 x 9.5mm |
| 7. | 83270 | Ford Main Shaft Bearing |
| 8. | 4443 | Main Shaft Ford 5000 6600 Late 16/18/30T 30 Teeth - 18 Teeth |
| 9. | 4434 | Gear Ford 5600 6600 NDP Reverse 32/28T |
| 10. | 4444 | Gear Ford 5000 6600 7600 Second 43/28T |
| 11. | 6212YR1CS | Counter Shaft Bearing Ford |
| 12. | 4635 | Gear Ford 7600 Secondary 16-34-16T |
| 12A. | 4641 | Gear Ford 5000 Secondary (16-35-16T) |
| 13. | 4217 | PTO Shaft Ford 15 Splined Long |
| 14. | 4645 | Counter Shaft Ford 7600 15-20-29-28T |
| 15. | 2963 | Hydraulic Pump Idler Gear Hub Ford 6600 6610 |
| 16. | 4436 | Hydraulic Pump Idler Gear Ford 10 5000 7000 55 Teeth |

7610/7710/6610 Transmission

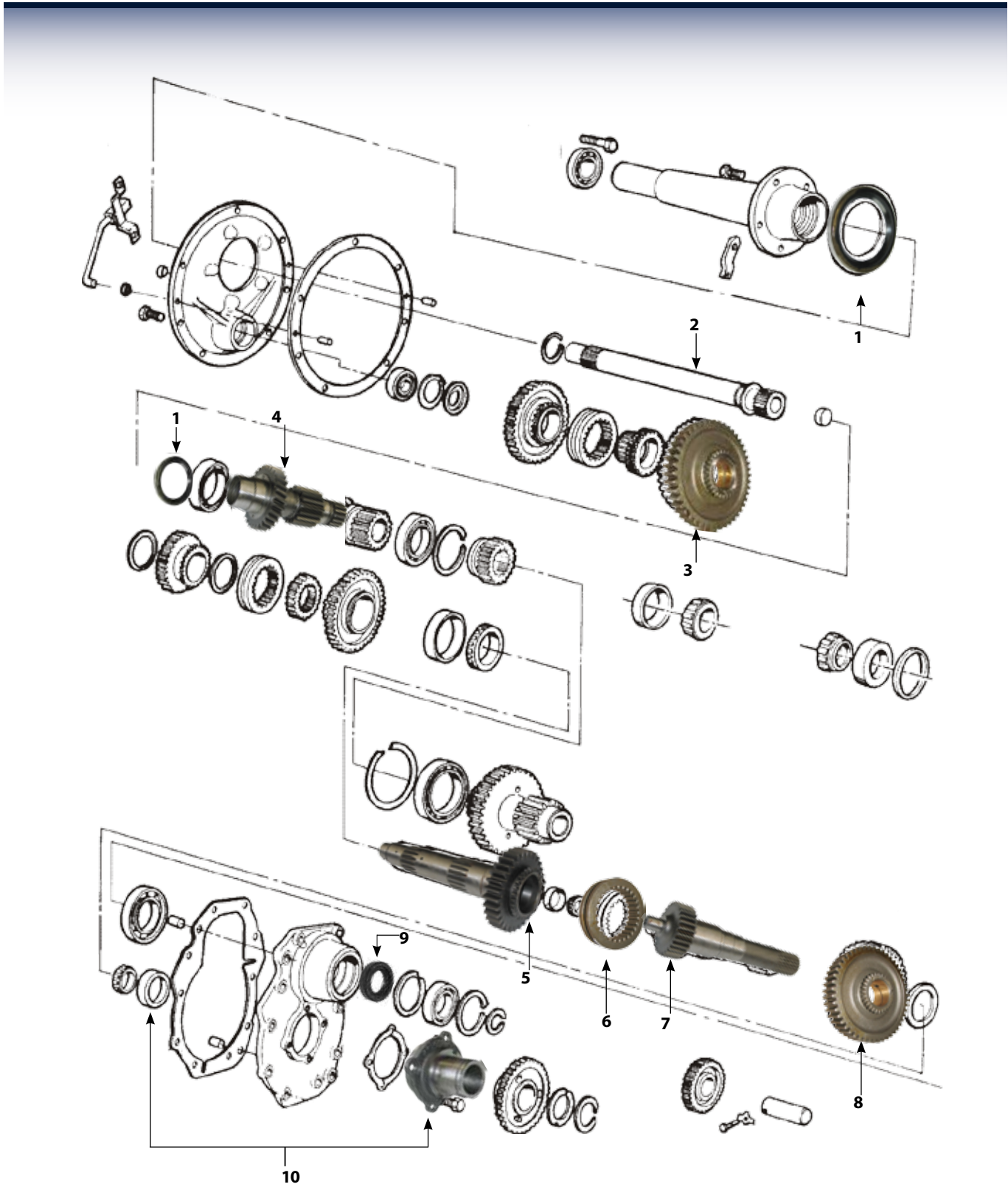

7610/7710/6610 Transmission

- | | | |
|-----|-------------|---|
| 1. | 4100 | Input Shaft Seal Ford TS,40,6610-7810 39.72 x 79.39 x 9.5mm |
| 2. | 4647 | Main Input Shaft Ford 10 & 40 Series - 16T 490mm |
| 3. | 4516 | Gear Ford 6610 First (46-28T) |
| 4. | 4649 | Shaft Top Main Ford 7600 29-18-16T Helical Teeth |
| 4. | 4648 | Shaft Ford 6610 Top Main 16/30/18T Straight Cut |
| 5. | 4636 | Shaft Ford 6610 Bottom (17-20-30-28T) |
| 6. | 4651 | Outer Sleeve (28T) for 4639 |
| 7. | 4639 | 7610 Bottom Shaft Gear + SLE (28T) |
| 8. | 4644 | 7610 Output Gear 49-28T + - DP |
| 9. | 1902 | Seal PTO Counter Shaft Ford 5600 7700Dexta / Super Dexta Gear Box Bearing |
| 10. | 2963 | Hydraulic Pump Idler Gear Hub Ford 6600 6610 |

4816
Gasket Ford 40 TS90 100
110 115

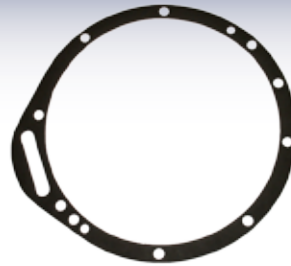

41541
Release Bearing Support Plate Ford 6610 6640
Also fits 7740



7593
Seal Spigot Shaft Ford 30 F MTM

16x16 Transmission Top Shaft Forward Half (11/91 to 12/98)

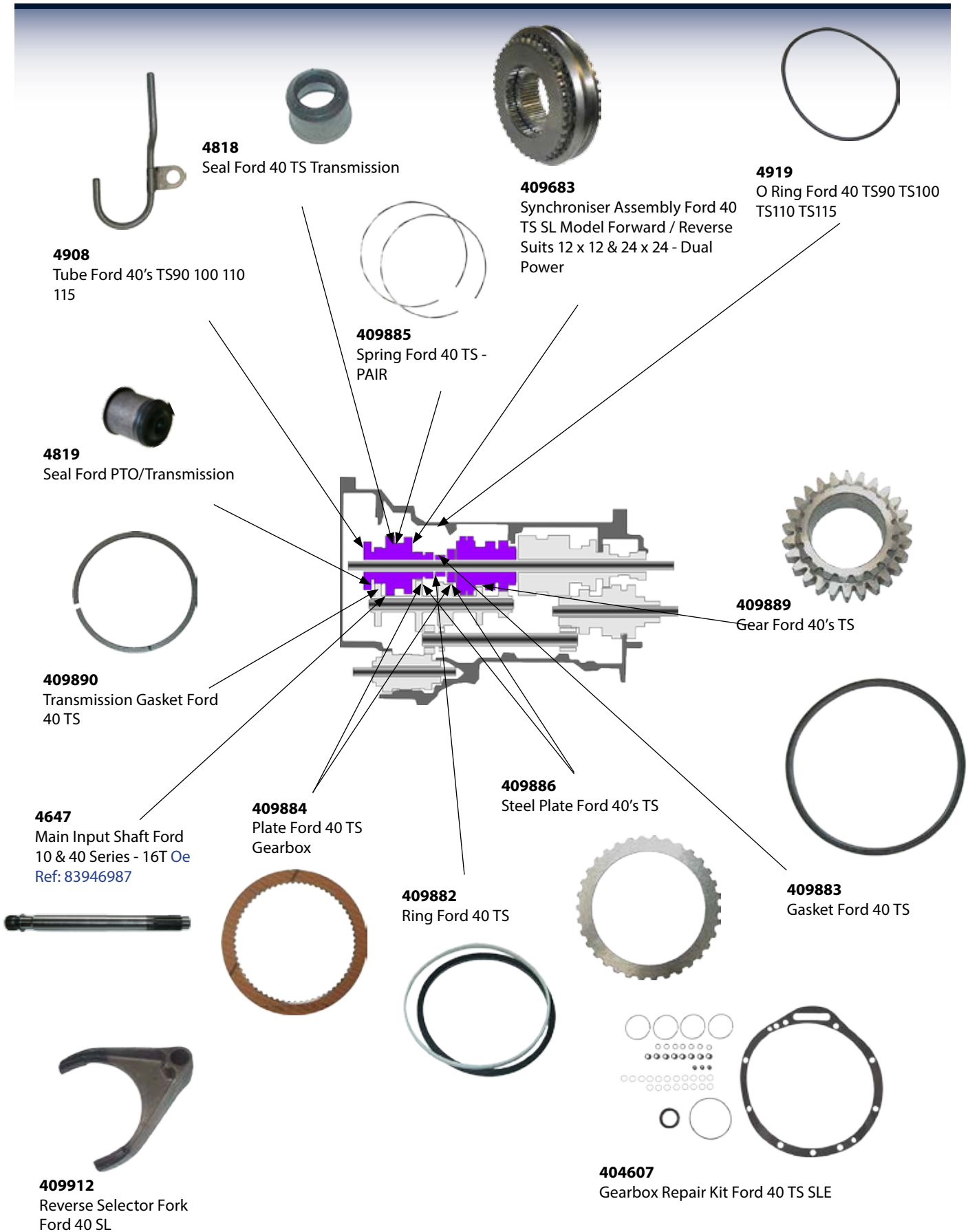

Transmission Lower Shafts (11/91 to 12/98)

When Working On 40'S/Ts's 4Wd Gear The Seals Needed To Reseal The 4Wd Unit Are 4831 X 14873 X 14830 X 14907 X 1409791 X 1

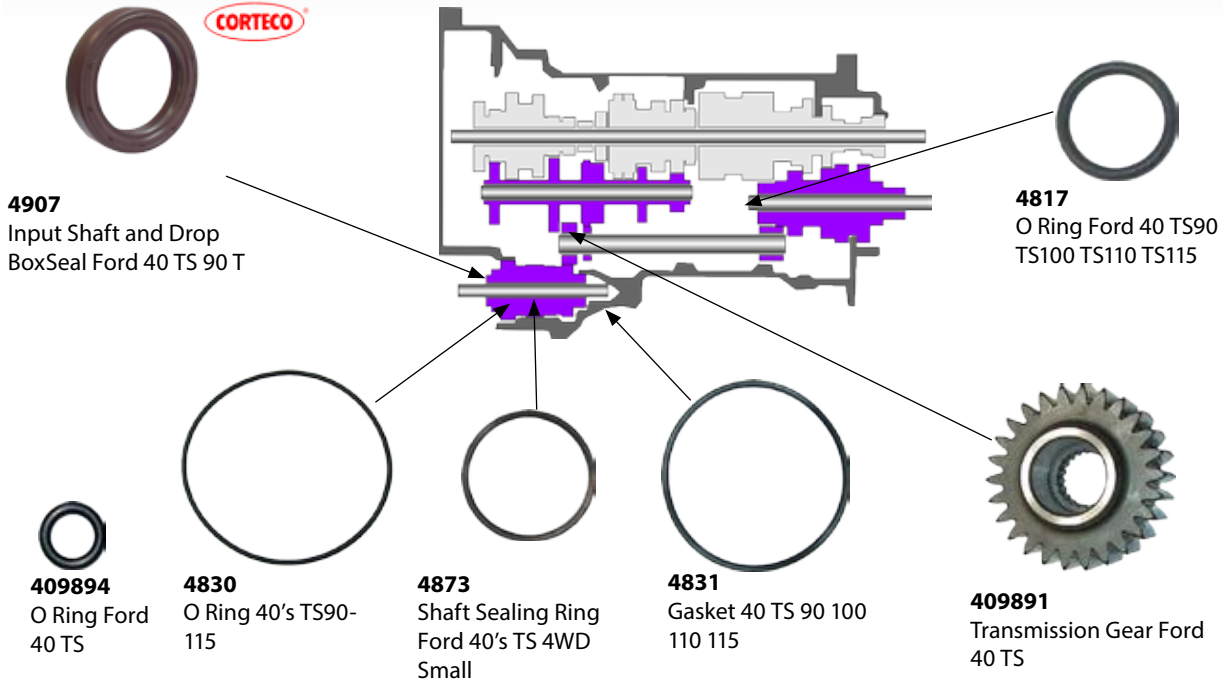

16x16 SLE Transmission Top Shaft Rear Half (11/91 to 12/98)

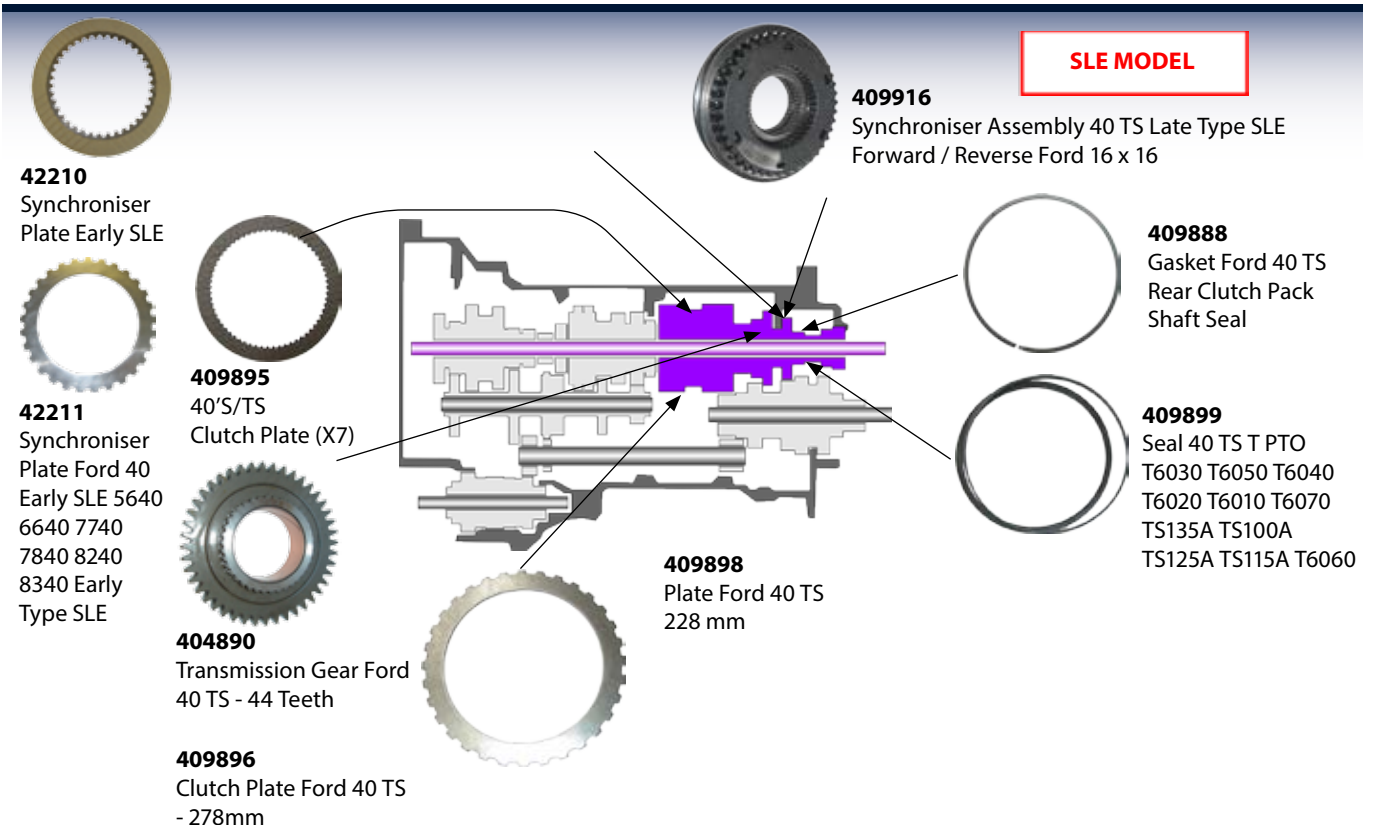

40's/TS Transmission Components

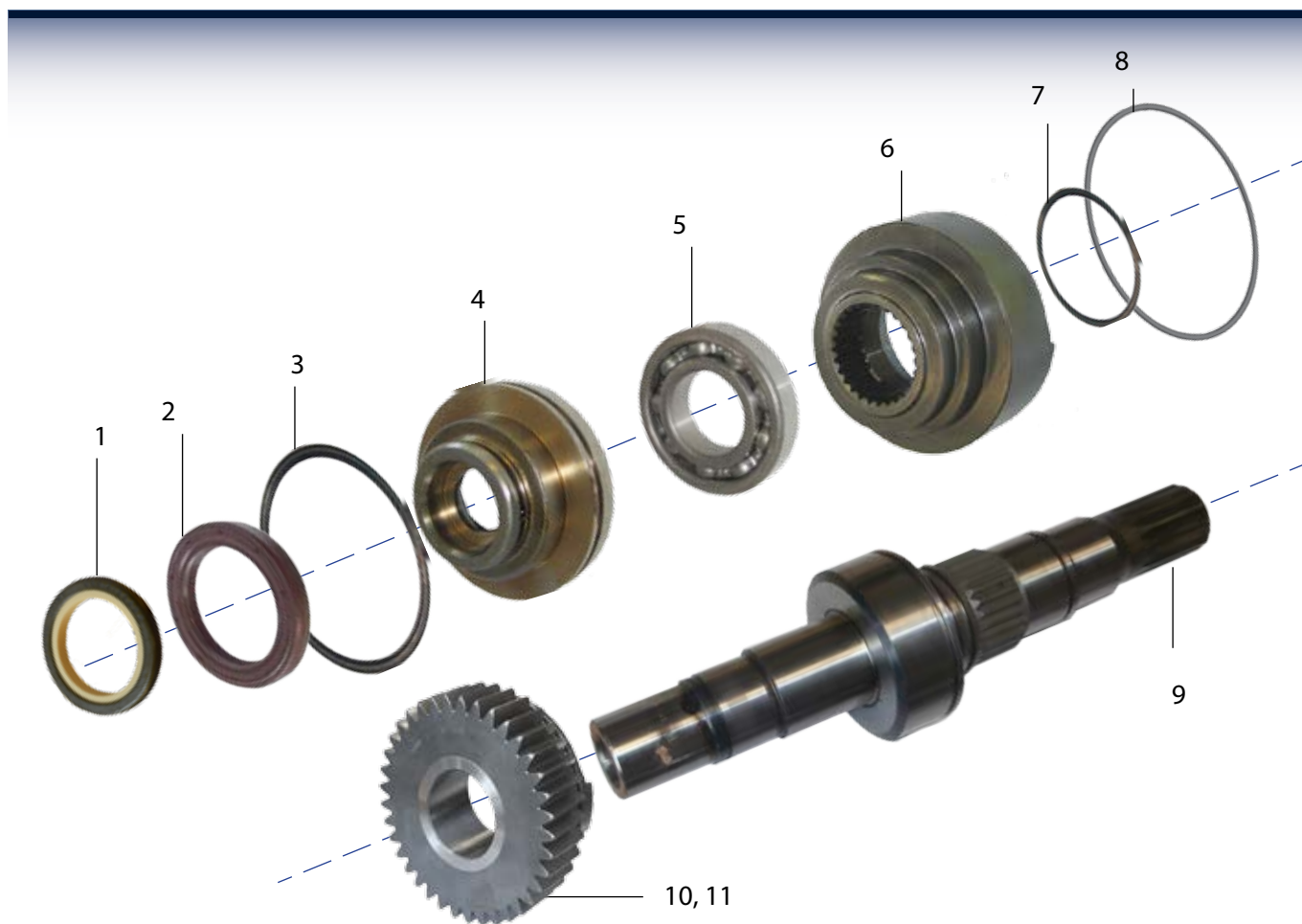

1	409791	Front Dust Seal Ford 40 TS 4WD - OD 50.15mm ID 35.5mm Height 6.15mm	OE REF: 81864224
2	4907	Input Shaft and Drop Box Seal 40 TS 90 TTS115 36x50x10 - Suits Late TS	OE REF: 81864243
3	4830	O Ring 40's TS90-115	OE REF: 89840056
4	409682	Cover TS 90-115 4WD Clutch Housing Start Year 92	OE REF: 81866322
5	7434	Bearing	OE REF: 20915780
6	403965	Gear Coupling 4WD	OE REF: 82852799
7	4873	Shaft Sealing Ring Ford 40's TS 4WD Small	OE REF: 81869803
8	4831	Gasket 40 TS 90 100 110 115	OE REF: 81869804
9	43300	Shaft Drop Box 8340 7840 7740 6640 5640 8240 TS115 TS110 TS100 TS90	OE REF: 81867433
10	403964	Gear Ford 5640 8340 TS100 TS115 4WD 38 Teeth	OE REF: 81874584
11	403963	Gear Ford 5640 8340 TS100 TS115 4WD 37 Teeth	OE REF: 81865812

40's/TS Transmission Components



51649
Gear Box Flange c/o Sleeve
Ford 40s TM/TS (S)

409713
Drop Box Shaft Seal Ford 40
4WD 35 x 50 x 10 - Suits 40s
and Early TS

404881
Transmission Duct
Ford 40 TS

4100
Input Shaft Seal Ford
TS,40,6610-7810 39.72 x
79.39 x 9.5mm



409892
Gear Ford 40 TS, 48 & 42 Teeth
SLE Dumb Bell Less Creeper Box

409912
TS'S 40's Reverse
Selector Fork

41661
Snap Ring Main
Transmission Shaft Ford
TC40D

409656
Oil Pressure Switch Ford
40 Transmission Also Fits
TS90-115

Accumulators



43607
Accumulator New Holland Transmission T6000
Series T7 Series T7000 Series Steyr 6160CVT
6130CVT 6145CVT 6165CVT 6210 CVT
[OE Ref: 87314179](#)

42181
Accumulator Transmission
Oil Ford 7840 From
09/01/1995

43273
Accumulator New Holland Brake Valve &
Transmi T7030 T6030 T6050 TM190 TS115A
TS130A TL100A T6040 T6020 TS100A TL80A
T6010 T7050 T6070 TS135A TS100A TM175
TS125A T7040 T7060 T6060 [OE Ref: 5195043](#)

Synchronisers



41648
Synchroniser Assembly Ford TM120 - 155
Forward & Reverse **Semi-Power-Shift Transmission**



43347
Synchroniser Ford TM Forward Reverse
Mechanical Gearbox
OE Ref: 5186638



41725
Synchroniser Assembly
TM120 - 155, T6030 - T6080
Central Reduction Unit - High / Low



43676
Synchroniser 24 x 24 Transmission
New Holland T6000 TSA T6 Serie
OE Ref: 47124378

TM Range Command Clutch Pack Repair Kits



42161
Repair Kit Ford TM Clutch
Pack A & B Range Command
TM130 TM140 TM155 TM12
OE Ref: 87530796

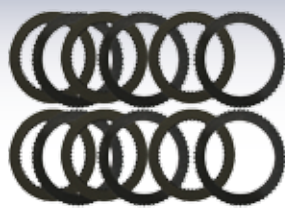

42183
Repair Kit Clutch Pack **Ford C**
TM Range Command TM130
TM140 TM155 TM120
OE Ref: 5167875



42184
Repair Kit Clutch **Pack D**
& E TM Range Command
TM130 TM140 TM155 TM120
OE Ref: 5165058



409858
Dual Power Spring Ford 40 TS - 5
per Tractor Spring Clutch Pack A
& B TM - 7 per Tractor** Kit 42938
** OE Ref: 81878948

TM Transmission Components



43085
Bearing Wet Clutch Pack Ford TM Rear
OE Ref: 5162399



43086
Bearing Wet Clutch Pack Ford TM Front
OE Ref: 512246 / 5122846



43124
Bush Transmission Gear Ford 60s
Ms T6s TMs

42163
O Ring Transmission Input
Shaft TM



42164
Seal Transmission
Input Hub Seal TM



43081
Piston Sealing Ring Powershift
Transmission F TM120 Large



43110
Tube Oil Delivery Input Housing
Ford TM's T6/T7/60's



42165
Bushing Spigot Shaft Ford TM



43027
Selector Fork
Ford TMs



43069
Taper Roller Bearing Ford
New Holland 60 TM M
T6000 47.5 x 100 x 27.25



43067
Taper Roller Bearing
Transmission Ford TM
50 x 110 x 29.25

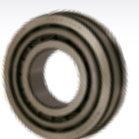

41944
Selector Fork Rail Ford 8160 - 8560 M
Series and TM Series Long



41651
Selector Fork Pad Ford TM115 - 165 New
Holland 8160 - 8560 and M Series



41589
Sleeve Ford M TM 60
Clutch Engagement



24x24 Transmission 40km/h Hi-Lo

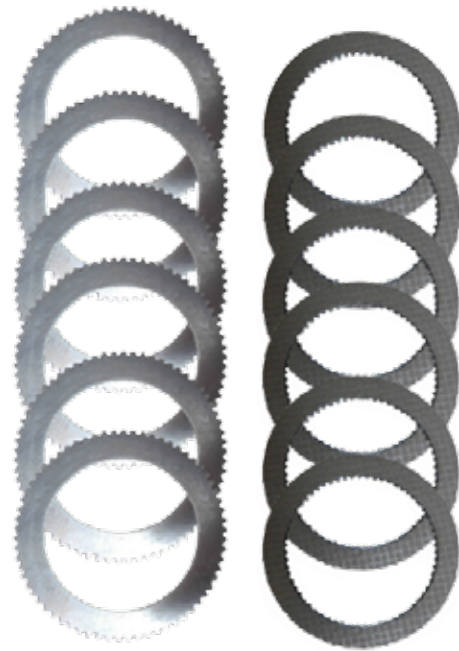

43149

Clutch Pack Ford T6 TSA Case MXU
Transmission 24x24 40km/h Hi-Lo

TW Dual Power

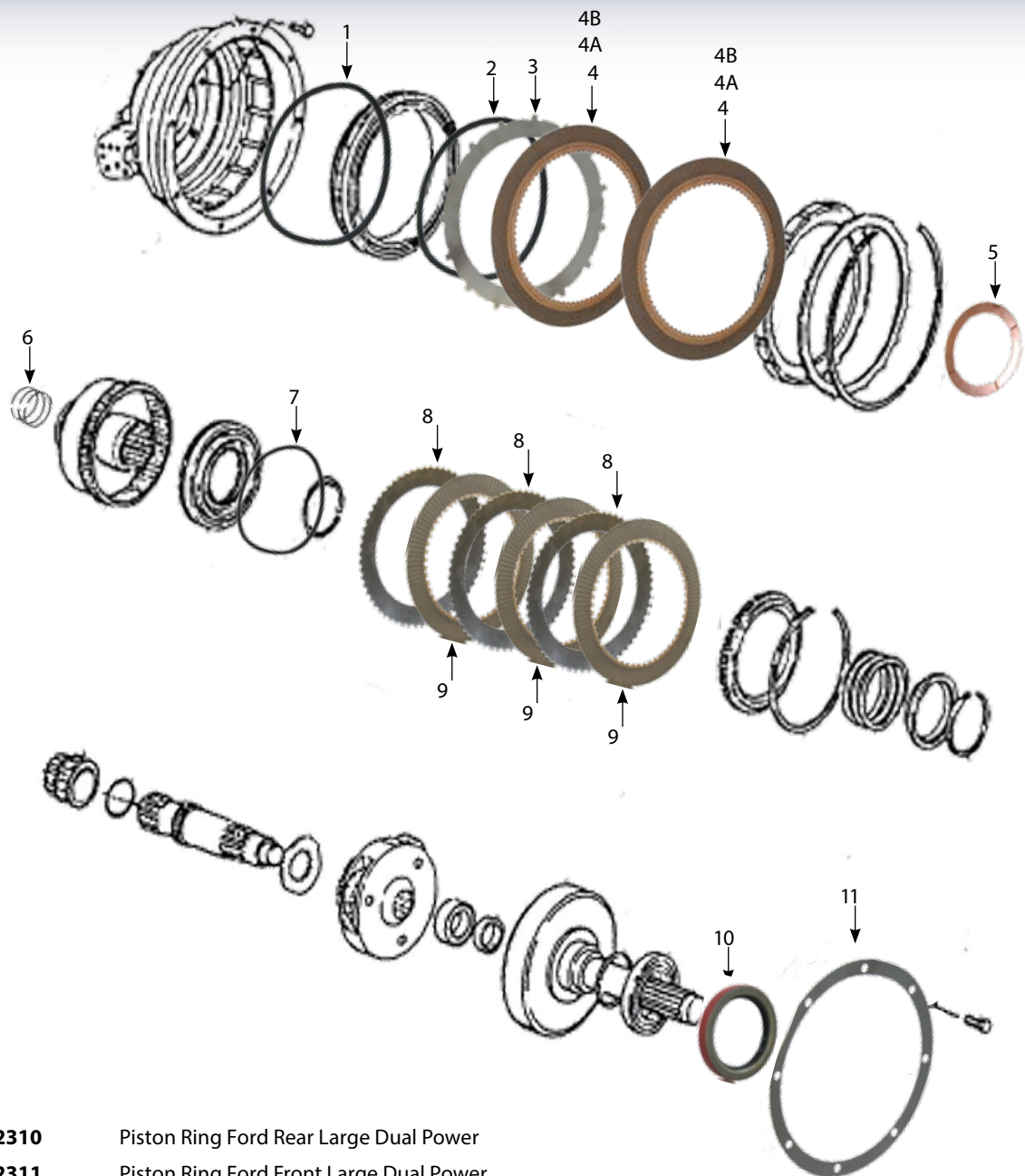

- | | | |
|----|--------------|--|
| 1 | 2310 | Piston Ring Ford Rear Large Dual Power |
| 2 | 2311 | Piston Ring Ford Front Large Dual Power |
| 3 | 2312 | Steel Plate Ford 7610 7710 Large Dual Power |
| 4 | 3826 | Disc Ford Dual Power Sintered - 2.10mm |
| 4a | 41297 | Ford TW Large Dual Power Plate |
| 4b | 1411 | Clutch Plate Ford 7610 DP Large Sintered |
| 5 | 1494 | Thrust Washer Ford 6600 Dual Power |
| 6 | 3408 | Sealing Ring Ford Dual Power Genuine - SET 3 Teflon PTFE |
| 7 | 3353 | Piston Ring Ford 5610-7710 Large |
| 8 | 2063 | Disc Ford Dual Power Steel |
| 9 | 2270 | Friction Disc Ford 5610 8210 TS TW Dual Power |
| 10 | 3801 | Ford Large Dual Power Seal |
| 11 | 3802 | 56/7700 DP Cover Gasket |

100/10's Dual Power Parts

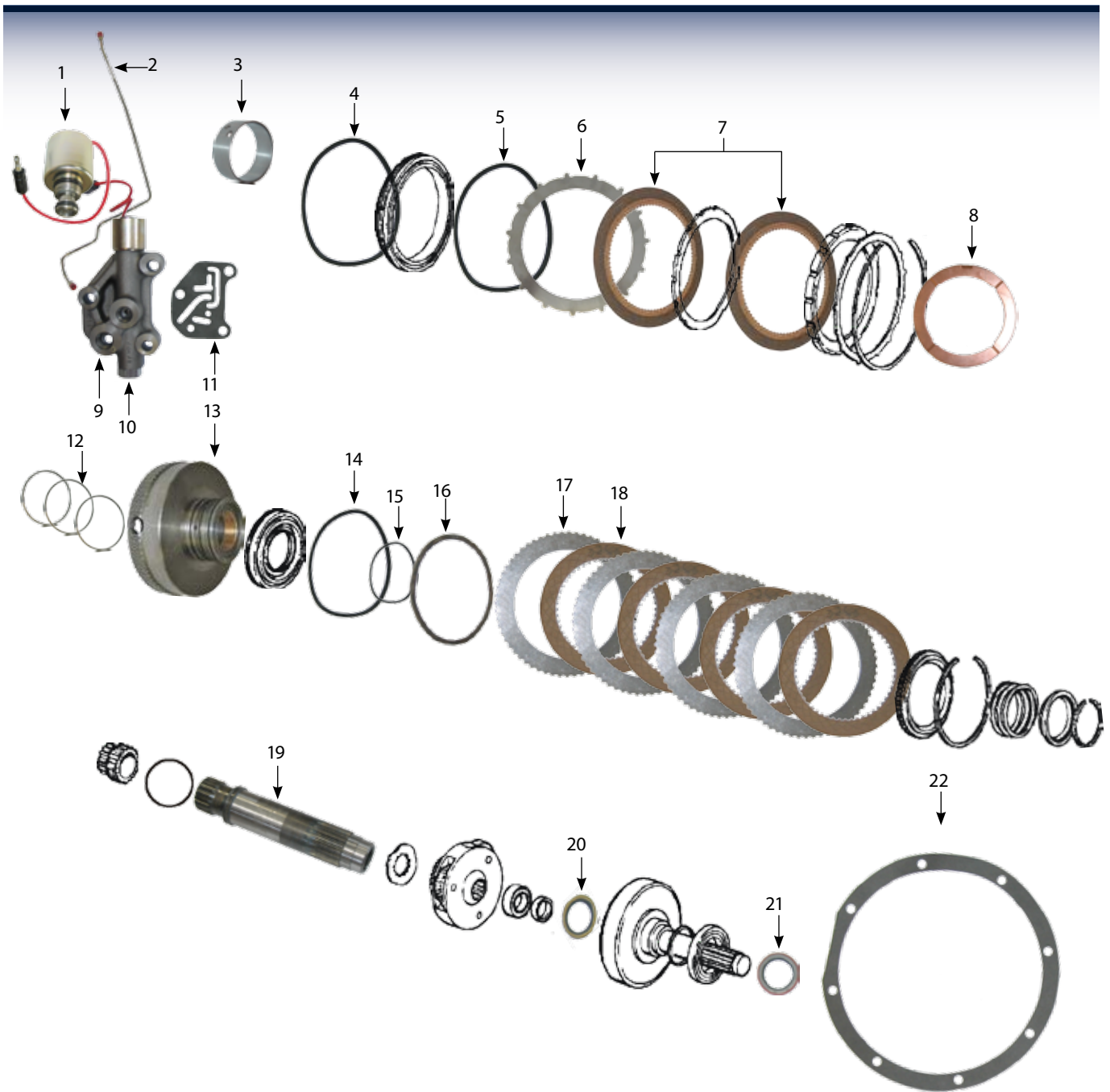

42198
Gasket Ford
Dual Power
Kit = 2118



42201
Gasket Ford
Dual Power
Kit = 2118



42202
Gasket Ford
Dual Power
Kit = 2118



42197
O Ring Ford
Dual Power
Kit = 2118



42199
O Ring Ford
Dual Power
Kit = 2118



42200
Gasket Ford
Dual Power
Kit = 2118

100/10's Dual Power Parts

- | | | |
|-----|----------------|---|
| 1. | 53089 | Solenoid for Dual Power Valve Suits 4410 + 4411 |
| 2. | 409843 | Dual Power Pipe Ford 10's |
| 3. | 1286 | Ford Collar for Dual Power |
| 4. | 2310 ● | Piston Ring Ford Rear Large Dual Power |
| 5. | 2311 ● | Piston Ring Ford Front Large Dual Power |
| 8. | 1494 | Thrust Washer Ford 6600 Dual Power |
| 9. | 4411 | Valve Assembly Ford Dual Power 10s Non Synchronesh |
| 10. | 4410 | Valve Assembly Ford Dual Power 30 10 's & TW 5 15 25 35 Synchro |
| 11. | 2904 | Gasket Ford 10 Dual Power Transmission Assemb |
| 12. | 3408 ● | Sealing Ring Ford Dual Power Genuine - SET 3 |
| 13. | 41489 ● | Hub Ford 10 40 Dual Power - Shell Only |
| 14. | 3353 | Piston Ring Ford 5610-7710 Large |
| 15. | 37226 ● | Piston Seal Ford 56-7600 (Inner) |
| 16. | 3484 ● | Ford IPTO Spring |
| 19. | 4283 | Input Shaft Ford 5610 7710 Dual Power |

6600 / 7600

6610 / 7610

- | | | |
|-----|-------------|--|
| 6. | 2312 | Steel Plate Ford 7610 7710 Large Dual Power |
| 7. | 3826 | Disc Ford Dual Power Sinterd - 2.10mm |
| 18. | 3348 | Friction Disc Ford 6600 - 7610 Dual Power Also for 7840 8210 TS Bronze |
| 17. | 3349 | Steel Disc Ford 5000 7000 7600 TW5 15 25 35 (1.90) mm - D/P |

- | | | |
|-----|-------------|--|
| 6. | 2312 | Steel Plate Ford 7610 7710 Large Dual Power) |
| 7. | 1411 | Clutch Plate Ford 7610 DP Large Sintered 4.6mm |
| 18. | 2082 | Disc Ford Dual Power Steel - 2.6mm |
| 17. | 2270 | Friction Disc Ford 5610 8210 TS TW Dual Power |

- | | | |
|-----|---------------|---|
| 20. | 3820 | Input Shaft Seal Ford Dual Power |
| 21. | 3801 | Ford Large Dual Power Seal |
| 22. | 3802 ● | Gasket Ford 5600 7700 Cover - Dual Power |
| 23. | 2118 ● | Seal Kit Ford Dual Power |
| 24. | 2455 ● | Floor Switch Ford TW Dual Power TW from 88 ** 2466 is Early Type ** |
| 25. | 2466 ● | Floor Switch Ford TW Dual Power Up to Year 88 ** 2455 is Late Type ** |
| 26. | 2957 | Switch Ford 10 Dual Power |

● Items included in kit 2118

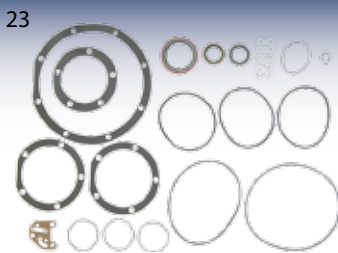

41489
Ford 10/40'S
Dual Power Hub



409864
Piston Ring Ford 40 TS TM
TL - Small Dual Power

40 Series Dual Power

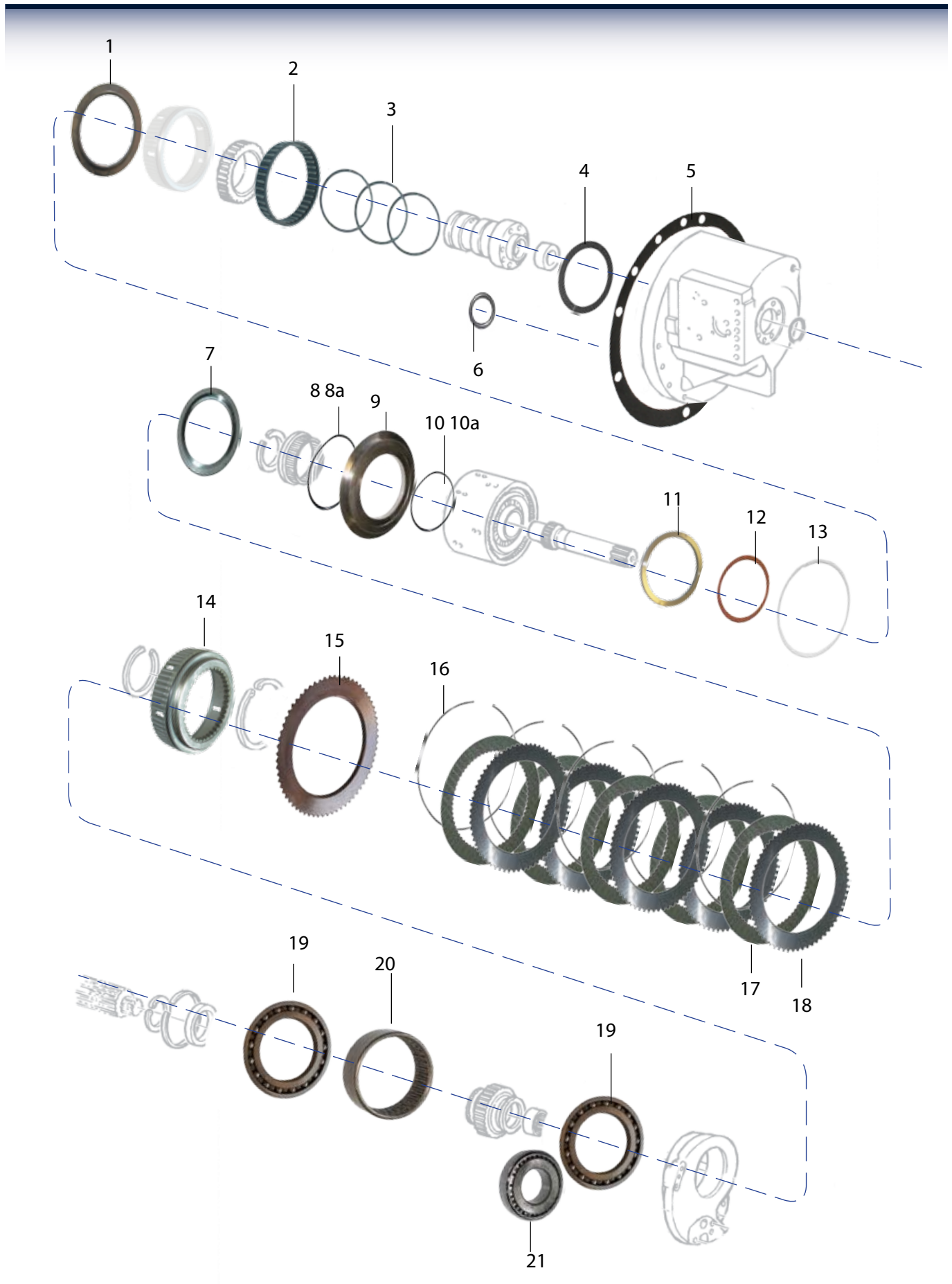

40 Series Dual Power

1	409732	Thrust Washer Ford 40 Dual Power
2	404885	Transmission Bearing Assembly Ford 40 TS
3	409865	IPTO Sealing Ring Ford 40 TS - SET 3
4	409808	Washer Ford 40 TS Dual Power
5	409809	Ford 40/TS's Dual Power Gasket
6	409807	O Ring Ford 40 TS Dual Power
7	409862	Thrust Washer Ford 40 TS Dual Power
8	409857	Ford 40's Dual Power External Sealing Ring (Old Type pre 11/95)
8A	409863	Piston Ring Ford 40/TS's Large
9	409777	Piston Ford 40 Dual Power New Type (95&UP)
10	409856	Ford 40's Dual Power Piston Seal
10A	409864	Ford 40/TS's Small Piston Ring (Qty 2)
11	409733	Spacer Ford 40's Dual Power
12	409805	Dual Power Shaft Sealing Ring Ford 40 TS
13	409806	Seal Ford 40 TS Clutch Drive Plate Inner
14	404883	Transmission Hub Ford 40 TS
15	409776	Clutch Plate Ford 40 Dual Power
16	409858	Dual Power Spring Ford 40 TS - 5 per Tractor Spring Clutch Pack A & B TM - 7 per Tractor
17	409859	Friction Disc Ford 40 TS Bronze Dual Power 5 per Tractor
18	409861	Friction Disc Ford 40 TS Dual
19	409775	Dual Power Bearing Ford 40 TS TW
20	409774	Ford 40's/TS Dual Power Needle Bearing
21	409773	Ford 40's/TS Dual Power Roller Bearing

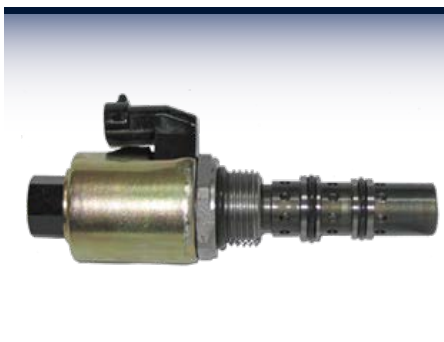

409730
Solenoid PMV Valve Ford For Dual Power C1/C2 Clutch Packs Case JXU M 6640 7840 TS100 TS110 8240 5640 TS115 OE Ref: 82006624

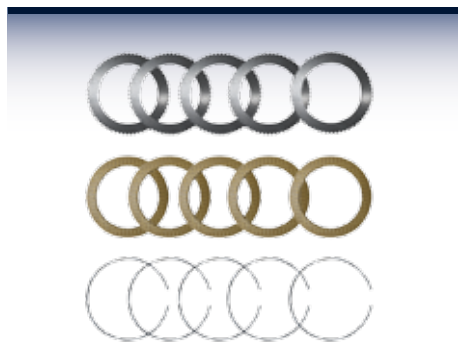

42938
Dual Power Clutch Repair Kit Ford 40 TS
** 1 Side only **

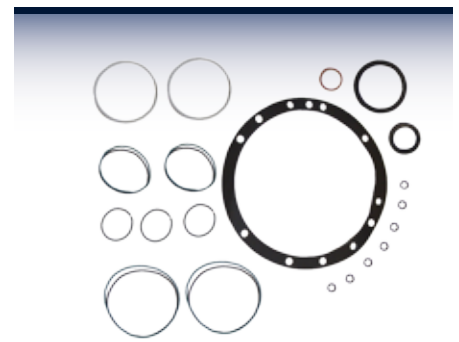

404606
Repair Kit Ford 40 Dual Power
** Suits Early & Late Type **
OE Ref: 409809, 409808,

40/TS Series Dual Power



409667
Range Cable Ford TM115-140 81-8360 For Mech T
Long Cable For Mech Trans A,B,C,D 32" overa



409668
Gear Cable Ford TM115-140 81-8360 for Mech Tr
Shorter Cable For Mech Trans 1,2,3,4 33.5"

409664
Transmission Shift Cable F R +1-8 Ford 5640-
c/o Actuator Forward / Reverse Cable
** Cable without Actuator is 409929 **



51649
Gear Box Flange c/o Sleeve
Ford 40s TM/TS (S)



43268
Shaft Gear Linkage Ford 5640 6640 7740 7840 8240 8340 TS90
TS200 TS110 TS115 1 per Tractor [OE Ref: 81875075](#)



FORD NEW HOLLAND **BUSH GEAR LINKAGE** 4 Per Tractor
5640 6640 7740 7840 8240 8340 TS90 TS200 TS110 TS115

Part No.	ID	OD	Height	OE
43269	20mm	28mm	11mm	81863170
43271	16mm	24mm	11.5mm	81863163
43270	20mm	28mm	6mm	81863164



43000
Cable New Holland
TS100 TS110 TS115 TS90
Forward/Reverse



43030
Transmission Gear Shift
Cable New Holland TS115
TS110 TS90



409929
Transmission Shift Cable FD+1-8 Ford
5640-834 Cable Only No Actuator
1060mm



409663
Transmission Cable Ford 5640 - 8340 High-
Low



43288
Cable Transmission Gear Shift HI LO
Ford TS90 TS100 TS110 TS115
[OE Ref: 82015807](#)



41489
Ford 10/40's Dual Power Hub



404862
7840 Flywheel Hub



Vintage PTO Parts

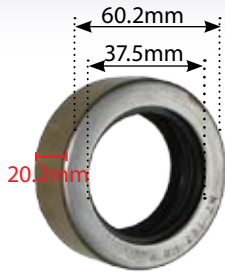

2826
PTO Seal Dexta & Super Dexta
60.2 x 37.5 x 20.2mm



41519
PTO Shaft Seal Housing Dexta



41683
PTO Cover Fordson Major



41136
PTO Support Ford 4000/4600



41235
PTO Oil Seal Major / Super Major
63.8 x 36.8 x 18.6mm - 2.5 x 1.5 x 0.73

41652
Spring For Pto Ball Locking device Fiat/
Ford 100 to 110/90, F's, L's, M's, TD, TL, TM



3889
IPTO Brake Pad Ford 5000



Clutches, Transmission & PTO

5600/6600/7600

5610/6610/7610/7810

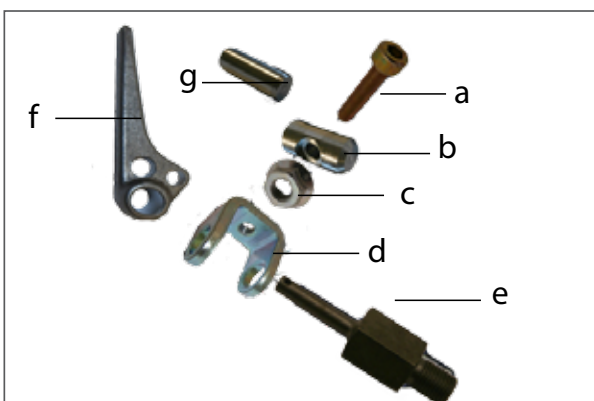
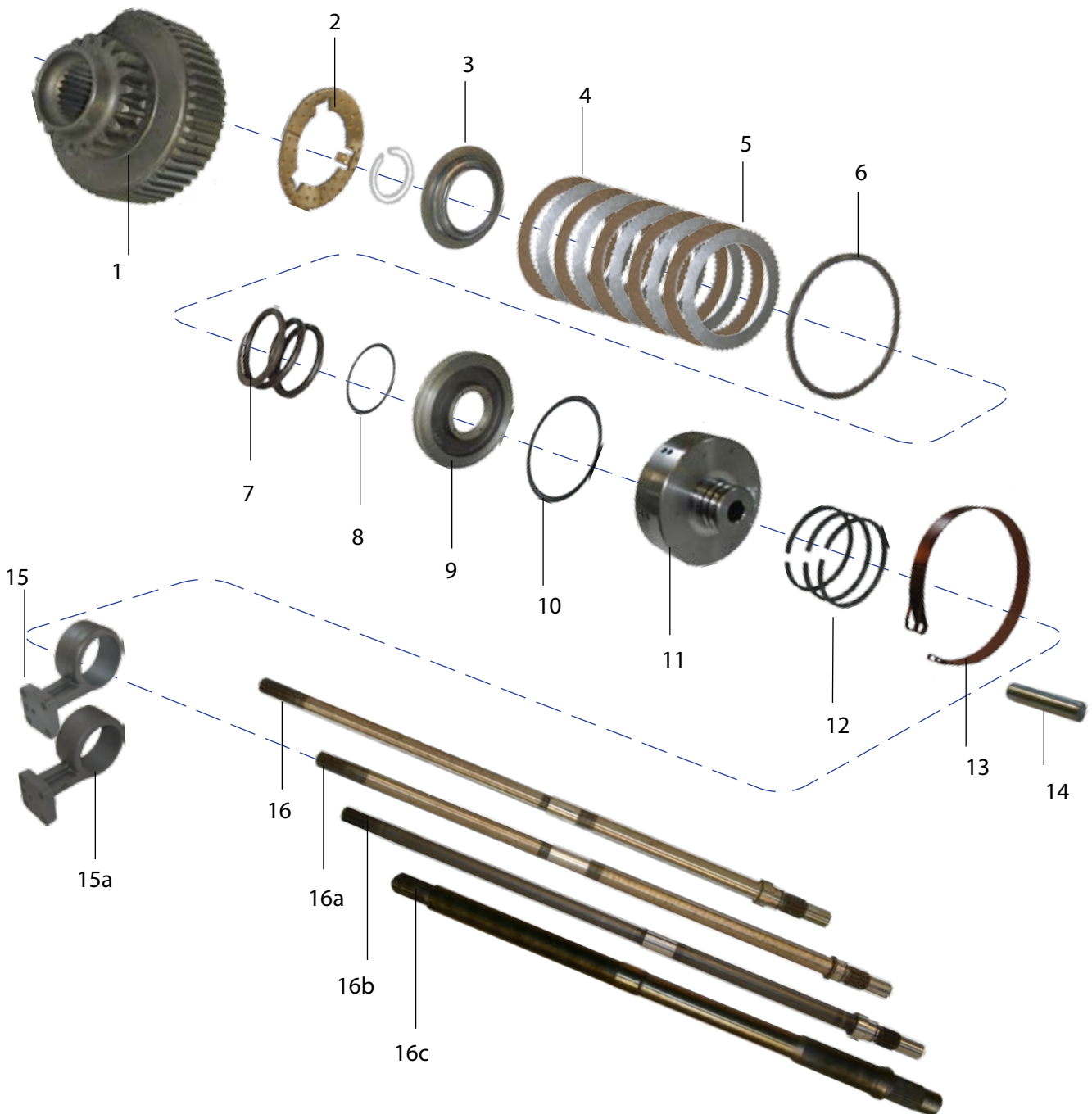

a	43115	Screw Hex Head IPTO Brake Band 40 TS TM
b	43114	Spacer IPTO Brake Band 40 TS TM
c	43102	PTO Band Fork Nut TO Band Fork Nut
d	43096	Clevis End PTO Clutch Brake Band
e	43116	Pin Threaded IPTO Brake Band 40 TS TM
g	43111	PTO Band Dowel
f	43117	Lever Pin IPTO Brake Band

5600/6600/7600 5610/6610/7610/7810

1	3352	IPTO Hub 5 Plate	OE REF: E0NNN750AA
2.	2362	PTO Washer 7600 7840 2 Speed	OE REF: 81801955
3.	41158	PTO Pack Spring Retainer	OE REF: 81804877
4.	3348	Friction Disc 6600 - 7610 Dual Power Also for 7840 8210 TS Bronze	OE REF: 83908229
5.	3349	Steel Disc 5000 7000 7600 TW5 15 25 35 (1.90) mm - D/P	OE REF: 81808607
6.	3484	IPTO Spring	OE REF: 81833907
7.	41144	IPTO Pack Spring	OE REF: 83935173
8.	BS227	IPTO O Ring 8210 TW5-35 Inner	OE REF: 83416992
9.	41145	IPTO Pack Piston	OE REF: 81876155
10.	3353	Piston Ring 5610-7710 Large	OE REF: 81805281
10A.	2910	PTO Pack Piston Seal 4000	OE REF: 81804503
11.	3354R	IIPTO Clutch Pack 5000 - 7600 2 Spd	OE REF: 83924794
12	4754	IPTO Sealing Ring - SET 3	OE REF: 81809513
13.	3356G	IPTO Brake Band 40 TS TM Genuine	OE REF: 83956644
13A.	3356R	IPTO Brake Band	OE REF: 83956644
14	43113	Dowl IPTO Brake Band 40 TS TM M5 x 22	OE REF: 10335010
15.	3357	IPTO Support	OE REF: 81826819
15a	4168	PTO Support (Old 5000 No Brake Band)	OE REF: 81818776
16.	3337	PTO Shaft 5000 - 7000 5610 6610 7610 7710 20 Spline	OE REF: 83948847
16a.	3656	PTO Shaft 7610 Syncro Long 20 Spline 40" 5110 5610 6410 6610 6710 6810 7410 7610 7710 7810 7910 8210 - 1020mm	OE REF: 83947157
16b.	4217	PTO Shaft 15 Splined Long	OE REF: C5NN7A684A
16c.	43305	PTO Shaft Transmission Output 10S	OE REF: 81801779

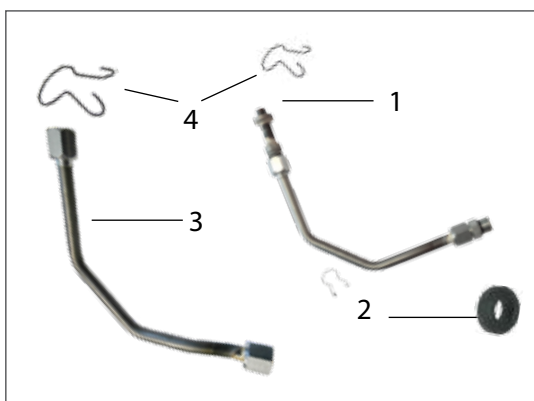

- | | | |
|---|--------------|--|
| 1 | 2087 | IPTO Feed Pipe 6610 - Adaptor is 42265 |
| 2 | 2000 | Hydraulic Pump Back End Olive 10's |
| 3 | 42264 | Pipe 6610 IPTO Feed |
| 4 | 41173 | Clip for IPTO Pipe 6610 |

5/6/7600 2 Speed PTO

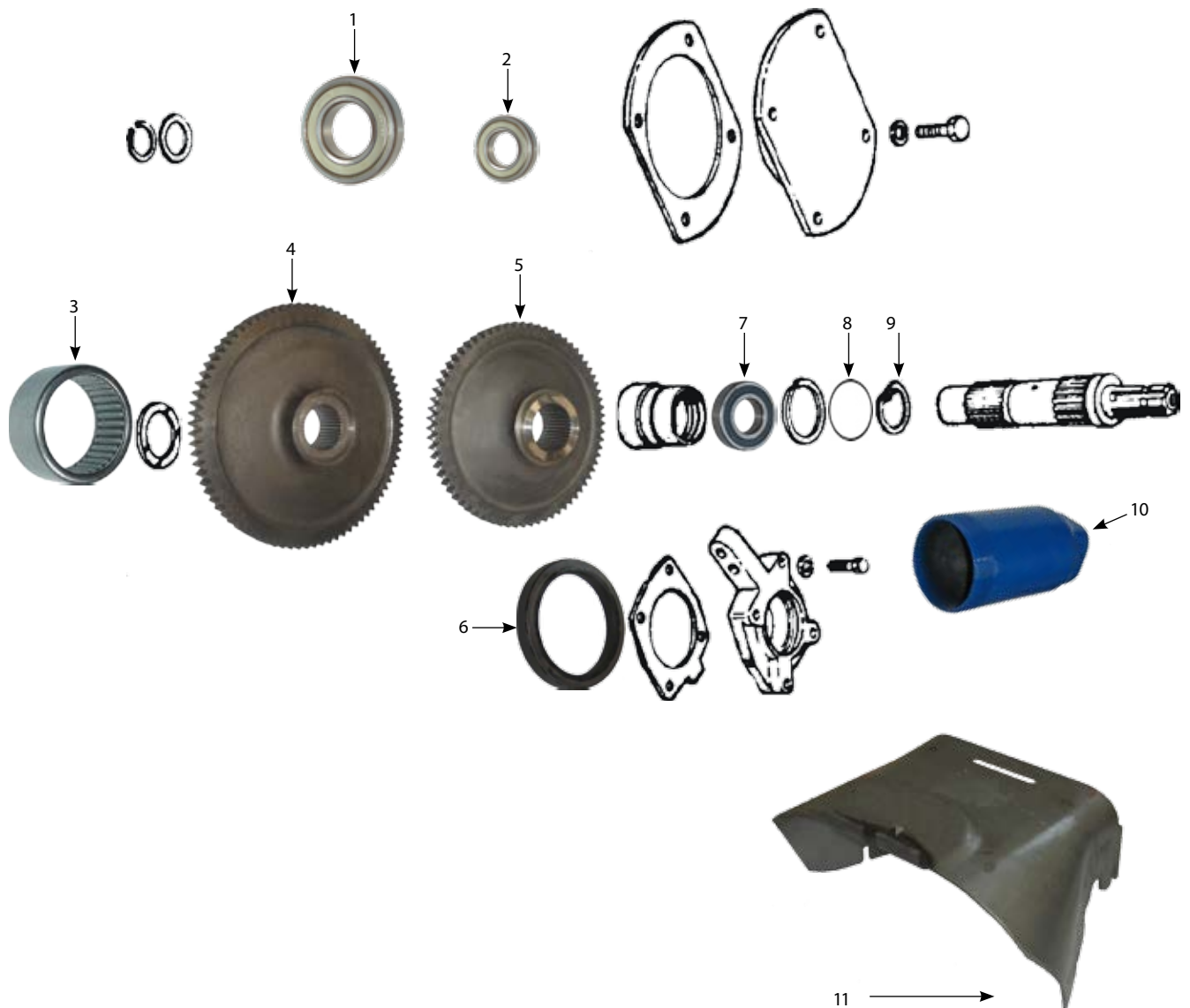

- | | | |
|-----|----------------|--|
| 1. | 6208ZZ | Bearing 200 600 |
| 2. | 6008ZZ | Bearing |
| 3. | B2414 | PTO Shaft Needle Bearing Ford 2 Spd |
| 4. | 2201 | Gear PTO 6600 540rpm 2 Speed |
| 5. | 2200 | PTO Gear Ford 5600 6600 7600 Also fits 5700 6700 7700 1000rpm 2 Speed 70 Teeth |
| 6. | 3340R | Seal Ford 5000 7000 Two Speed 56106610 6810 7610 95 X 74 X 13mm |
| 7. | 60152RS | Bearing |
| 8. | BS140 | O RING |
| 9. | 4577 | PTO Shaft Circlip Ford 2 Spd. |
| 10. | 4852 | PTO Cover Ford 6600 7600 4000 |
| 11. | 41394 | PTO Guard Ford 2000 - 5000 New Type |



Date:.....

No. of Pages:.....

Name of the Rep.....

A/C Number:.....

From:.....

e-mail.....

Phone No.:.....

Fax No.:.....

- Please quote for the following parts - Quotation Number :
- I wish to confirm the following order on Quotation Number:
- Please supply the following parts:

Please photocopy this page

Please do not remove this page

	Qty	Part No.	Description	Unit Price
1.				
2.				
3.				
4.				
5.				
6.				
7.				
8.				
9.				
10.				
11.				
12.				
13.				
14.				
15.				
16.				
17.				
18.				
19.				
20.				
21.				
22.				
23.				
24.				

Comments: _____

Customer Signature: _____ **Rep's Signature:** _____

Tel No: + 353 44 934 1638

e-mail: info@qtponline.com, www.qtponline.com

Page of

Clutches, Transmission & PTO

4000 PTO Parts



4852
PTO Cover Ford 6600 7600
4000



4274
PTO Brake
Ford 4000



2910
PTO Seal
Ford 4000



3332
PTO Shaft Ford 4000 4600 26T 6 Spl
540rpm



3350
Friction Disc Ford 4000 4600 Bronze



WG7C4
Case Forward Torque Disc

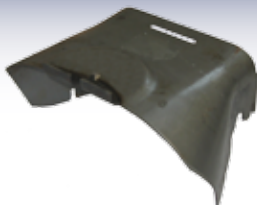

41394
PTO Guard Ford
2000 - 5000 New Type



2794
PTO Oil Seal Ford 2000 3000
4000 4600 62 x 40 x 17



41136
PTO Support Ford
4000/4600

6610/7610 2 Speed PTO

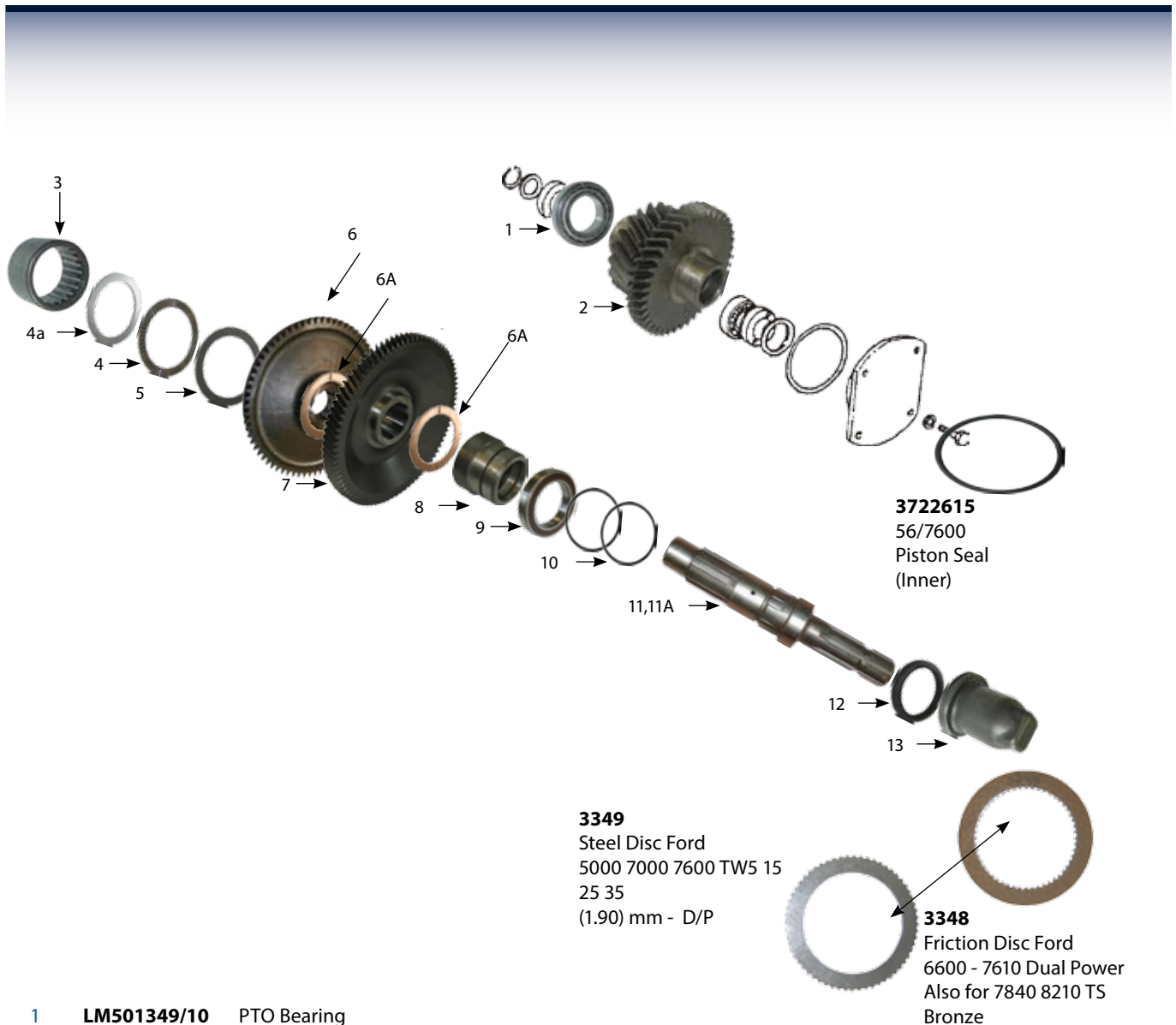

1	LM501349/10	PTO Bearing
2	2180	Gear PTO Ford 6610 7600 2 speed 20Th & 41Th
3	SCE2420	PTO Shaft Bearing Ford 10
4	2465	PTO Bearing Ford 7610
4a	2470	PTO Gear Thrust Washer Ford 7610 Thick
5	2464	PTO Washer Ford 7610
6	2249	PTO Gear Ford 7610 - 1000rpm 2 Spd 84 Teeth 230mm Diameter
6a	2463	PTO Brass Washer Ford 5610 7610
7	43235	PTO Gear Ford 7610 - 540 rpm 70 teeth 260mm Diameter
8	4634	PTO Shaft Carrier Sleeve Ford 7610
9	60152RS	Clutch Release Bearing Large
10	BS140	"O" Ring (Sleeve To Shaft)
11	3338	PTO Shaft Ford 7610 TW10 TW20 540rpm
11a	3548	PTO Shaft Ford 7610 40 TW's 1000rpm 21 Spline
12	3340G	Seal Ford 5000 7000 Two Speed Genuine - 3340R is replacement
13	42168	PTO Cover Ford 5000 - 7000 10s 40s TS

40 Series PTO 2 Speed Shiftable

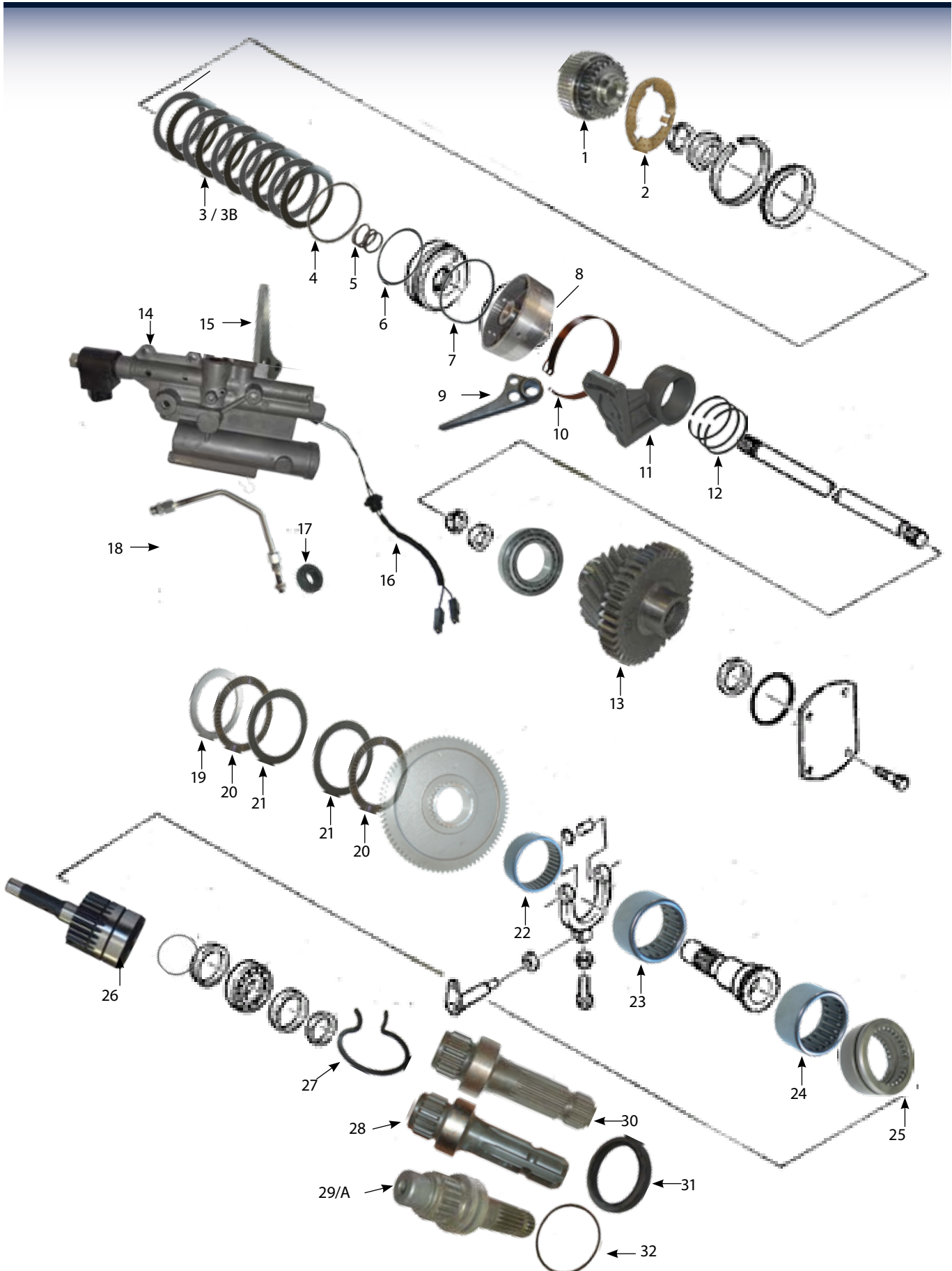

40 Series PTO 2 Speed Shiftable

- | | | |
|------|---------------|---|
| 1. | 409648 | PTO Hub Gear Ford 40 TS90-115 |
| 2. | 2362 | 7600/7840 2 Speed Pto Washer |
| 3. | 4751 | PTO Disc Ford TW 15 TW20 |
| 3B. | 3349 | Steel Disc Ford 5000 7000 7600 TW5 15 25 35 (1.90) mm - D/P |
| 4. | 3484 | Ford IPTO Spring |
| 5. | 41144 | Ford IPTO Pack Spring |
| 6. | BS227 | 40'S Inner Ipto O Ring |
| 7. | 3353 | 7840 Large Piston Ring |
| 8. | 409909 | PTO Pack Ford 40's |
| 9. | 43117 | Lever Pin IPTO Brake Band 40 TS TM |
| 10. | 3356G | 40'S IPTO Brake Band |
| 10A. | 3356R | IPTO Brake Band Ford |
| 11. | 409842 | PTO Support Ford 40 |
| 12. | 4754 | Ford Ipto Sealing Ring (Set Of 3) |
| 13. | 409851 | Gear PTO Ford 40 2 Speed Top 20Th & 39Th |
| 14. | 409708 | PTO Valve Assembly Ford 40 TS - SLE ONLY |
| 15. | 1434 | 40'S IPTO Brake Finger |
| 16. | 409724 | 40'S Pto Solenoid Wire Assy |
| 17. | 2000 | 40'S Hydraulic Pump Back End Olive |
| 18. | 2087 | 40'S IPTO Feed Pipe |
| 19. | 2470 | 40'S Thrust Washer |
| 20. | 2465 | 40'S PTO Bearing |
| 21. | 2464 | 7610 PTO Washer |
| 22. | 409847 | PTO Drive Bearing Ford 40 |
| 23. | 409846 | PTO Drive Bearing Ford 40 Inner |
| 24. | 409845 | PTO Drive Bearing Ford 40 Outer |
| 25. | 42047 | PTO Slide Selector Ford 40 Series |
| 26. | 409723 | PTO Output Housing Ford 40's 10 TS Shiftable |
| 27. | 4577 | PTO Shaft Circlip Ford 2 Spd. |
| 28. | 404603 | PTO Shaft Ford 40 540rpm 6 Spline |
| 29. | 42068 | PTO SHAFT T6 T7 TM TSA 1000RPM |
| 29A. | 42069 | PTO SHAFT T6 T7 TM TSA 540RPM |
| 30. | 404610 | PTO Shaft Ford 40 1000rpm |
| 31. | 3340G | 7840 Two Speed Pto Seal 3340R is replacement |
| 32. | 43108 | O Ring Power Take Off Ford T6030 T6050 TM150 TM130 TD90D |

TM190 TS115A TS130A TM140 TM155 TD70D TD80D TL100A
T6040 T6020 TM120 TS110A [OE Ref: 14459881](#)

42168
PTO Cover Ford
5000 - 7000 10s 40s TS
Two Speed



42265
Adaptor 6610 IPTO Feed
** Kit is 2087 **



409708
PTO Valve Assembly
Ford 40 TS - SLE ONLY

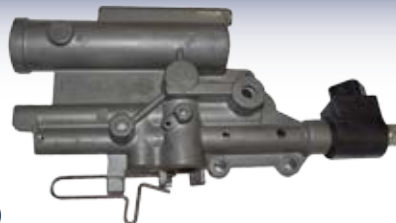

409844
PTO Drive Bearing
Ford 40

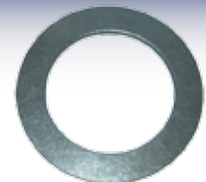

T Series PTO

42249
O Ring Plunger Ford TSA T6010
PTO Valve Assem - T6050 5600 -
8210 4000 - 7000



42173
PTO Selector Rod Ford TL
T5000 Series



43048
Seal PTO Clutch Ford
TM140 TL100 T5040
T5050T5060

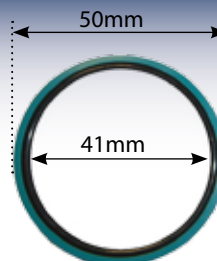

Clutches, Transmission & PTO

30's TW 5/10/15/35/35/PTO

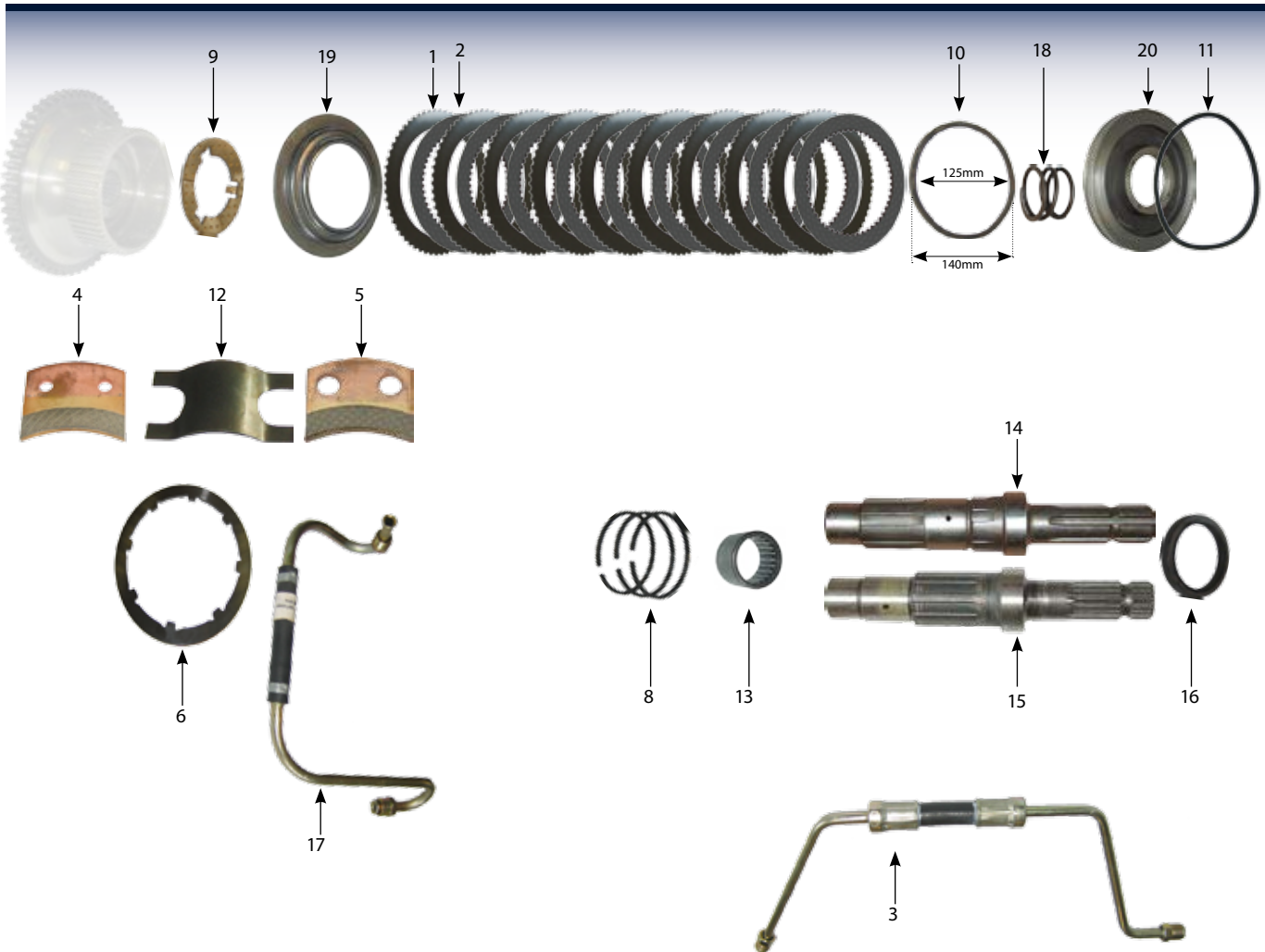

1	2082	D.Power Steel Disc(2.6Mm) 8530/8630/8730
2	4751	Tw Bronze Pto Disc (9 Per Set)
3	41012	IPTO Feed Pipe
4	1754	PTO Brake Pad Ford TW Small hole 9.8 mm Hole
5	1775	PTO Brake Pad Ford TW Large Hole 15.7mm Hole
6	1709	PTO Brake Disc Ford TW Steel
8	4754	Ipto Sealing Ring (3 Per Set)
9	2362	Ford Ipto Star Washer
10	3484	Pto Spring
11	3353	Large Piston Ring
12	2061	PTO Spring Ford TW
13	SCE2420	Pto Shaft Bearing Ford 10
14	3338	Tw10-20 540 Pto Shaft (6 Sp.)
15	3548	Tw10-20 1000 Pto Shaft (21 Sp.)
16	3340G	Tw Two Speed Pto Seal 3340R is replacement
17	41011	IPTO Return Pipe
18	41144	Ford Ipto Pack Spring
19	41158	Ford Pto Pack Spring Retainer
20	41145	Ford Ipto Pack Piston

PTO Parts



409677
PTO Switch TM115 TM120
TM125 TM130 TM135 TM140
TM150 TM155 TM16



409634
PTO Switch Ford 8160
8260 6360 8560 TS100
TS110 TS115 TS90

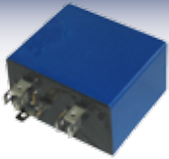

409651
PTO Control Module
Ford 40



409645
PTO Control Knob
Ford 40



409650
PTO Switch Ford 40



43604
PTO Solenoid T6000, T7000, T6, T7 Series
OE Ref: [87739558](#)



409636
Speed Sensor Ford TL TLA TM TN
TSA PTO Also fits a Fiat F Series



43684
PTO Speed Sensor New Holland T6 T5
Series OE Ref: [47767004](#)



409662
PTO 540 1000 Cable Ford 5640 7840
8340 TS90 1 Start Year 91



52448
PTO Cable TM115 TM120 TM125
TM130 TM135 TM140
OE Ref: [87331793](#)



41660
PTO Cable Bracket Ford
TM, 60's



41539
PTO Support Bolt
Ford 5000 6600
6610

PTO Covers



41320
PTO Cover Ford 3000 3600 3610



4852
PTO Cover Ford 6600 7600 4000

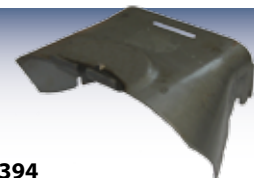

41394
PTO Guard Ford 2000 - 5000
New Type

42168
PTO Cover Ford 5000 - 7000
10s 40s TS



43568
PTO Guard Ford T5 T6 T7
TM TSA TL TLA
OE Ref: [47125899](#)



PTO Shafts

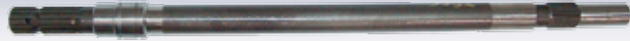

3332 4/4610 PTO Shaft



43465
PTO Shaft Ford 3900 4100 4600 2810 2910 3910 4110 4610 3230
3430 3930 4130 4630 5030 420 4550 [OE Ref: 83937193](#)



3333
PTO Shaft Ford 11" Single Speed



3334
PTO Shaft Ford 12" Single Speed 540rpm



3335
PTO Shaft Ford 5600 - 7600 540rpm 2 Speed



3336
PTO Shaft Ford 1000rpm 11.47" Long



3338
5610/7610 & Tw Series Shaft (540 RPM)



404603
40 Series / 7810/8210 2 Spd Shiftable PTO Shaft
(540 RPM)



3548
5610/7610 & TW Series Shaft (1000 RPM) 21 Spline

5710
PTO Shaft Fiat 2 Speed 540rpm 6 Spline Ford 4635, 4835, 5635,
7635, TL100, TL70, TL8 [OE Ref: 5185602](#)

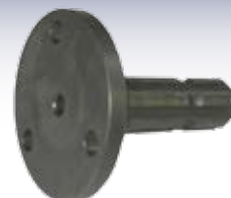

PTO Shafts



404610
40 Series PTO Shaft(1000 RPM)



3842
PTO Shaft Ford 10's 6 Spline 1000 RPM 5610 6410 6610 6710
6810 7010 7410 7610 7710 7810 7910 8010 8210 8530 8730
8830 5640 6640



42068
PTO Shaft T6 T7 TM TSA
1000RPM



42069
PTO Shaft T6 T7 TM TSA
540RPM



409723
PTO OUTPUT HOUSING
FORD 40'S SHIFTABLE PTO

43690
PTO Driving Gear New Holland TM165
Ford 8560 [OE Ref: 5162449](#)



42047
PTO Slide Selector Ford 40
Series **PTO Housing is
409723** [OE Ref: 83983829](#)



3340G
Genuine Modified 5/7000
2 Speed P.T.O. Seal
3340R is replacement

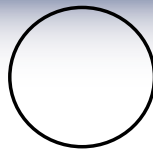

BS140
'O' Ring



3339
PTO Seal Ford 5000 - 7000 Single
Speed Fits 5110 - 7710



2794
Ford 4/4610
PTO Seal



42249
O Ring Plunger Ford TSA T6010
PTO Valve Assem



43466
PTO Oil Seal Ford T6s T7s TMs TSAs
[OE Ref: 5196487](#)

PTO Shafts & Related Parts

4293
PTO Hub Ford 15 Spline Old Type



409837 - Kit



15 Splined Ø

4217
PTO Shaft Ford 15 Splined Long

3342
PTO Shaft Hub Ford 20 Splined 2 - 7000
4600 - 7600 5610-8210 6640-8240 TS90-110



409838- Kit



20 Splined Ø

3656
PTO Shaft Ford 7610 Syncro Long 20 Spline 40"
5110 5610 6410 6610 6710 6810 7410 7610 7710
7810 7910 8210 - 1020mm

Position of Machine Spot

3342
PTO Shaft Hub Ford 20 Splined 2 - 7000
4600 - 7600 5610-8210 6640-8240 TS90-110



409839- Kit



20 Splined Ø

3337
PTO Shaft Ford Constant Mesh 5000 - 7000
5610 6610 7610 7710 Heavy Collar
20 Spline 40" 1020mm - 45° Pressure Angle

Position of Machine Spot

4442
PTO Shaft Hub Ford TW 10-20 22 Splined



2388
PTO Shaft Ford TW 22 Splined Long



404862
Hub Ford 7840 Dual Power 22 Splined



404861
Shaft Ford 7840 L/DP 22 Splined



4274
PTO Brake Finger Ford 4000



1434
IPTO Brake Finger Ford 5600 7600



Major Brake Parts



1005510
Spring Brake Actuator 165
Ford 7840 Square



1886562
Spring Brake Actuator
Round also fits Ford 40s
LTC TS



41384
Brake Shoe Spring
Major



41958
Brake Spring Kit, Major
Brake Spring Kit MajorOE
Ref: E27N2285B



16779X
Brake Actuator Ball 7/8"



41236
Brake Actuator Super
Major / Leyland



41444
Brake Disc Major 165mm 27
Splines - Dry



7604
Brake Linings Leyland/Fordson Ma-
jor + Rivets Side Of Tractor 48 Rivets
6 1/2" Wide 165mm



41592
Brake Shoe Major



41671
Brake Lining Major



41857
Brake Drum Cover
Major



41619
Seal Outer Major Drum
Type Brake 57.5 x 85 x
13.7mm - 3 3/8" x 2 1/4"



61826
Hand Brake Cable Major / Power Major LH 685mm
OE Ref: 81717355

61825
Hand Brake Cable Major / Power Major RH 685mm
OE Ref: 81802609

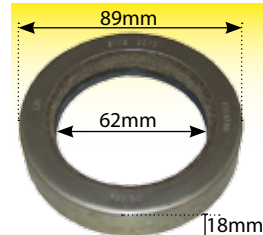

41451
Brake Axle Seal
Super Major



41452
Brake Boot Seal Major /
Leyland

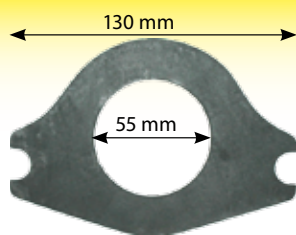

41455
Hand Brake Ware Plate Super
Major

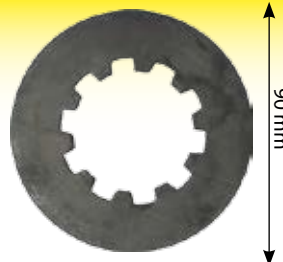

41454
Hand Brake Disc Super
Major



41470
Brake Pedal Bush Super
Major

Major Brake Parts



41907
Hand Brake Ratchet Fordson Major
Fits Standard Power & Super Major
Handbrake = 41939 / Pawl = 62598



41939
Hand Brake Major Ratchet =
41907 / Pawl 62598



42942
Hand Brake Major Straight Type
** 41939 is Bent Type **



62598
Hand Brake Pawl Ford Major
Handbrake = 41938 / Ratchet = 41907



41474
Hand Brake Spring Super Major



42021
Hand Brake Rubber Major / Super
Major



41235
PTO Oil Seal Major / Super Major



1851533
Bearing 135 188 Crown Wheel
Half Shaft Bearing Major &
Power Major



41456
Rear Axle Seal Super Major
Complete Half Shaft Seal Major
Power & Super Major



41447
Input Shaft Seal Super Major



41448
Input Shaft Seal Super Major Large
85 x 111 x 12.5mm



41485
Transmission Seal Super Major



41450
Steering Box Seal Super Major
35 x 47 x 7mm



41464
Auxiliary Drive
Seal Major

Dexta Brake Parts

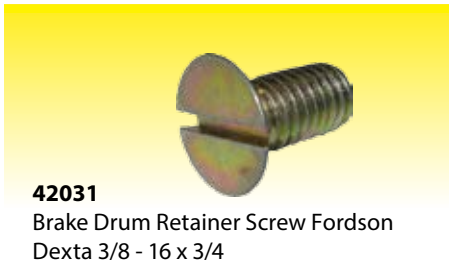

42031
Brake Drum Retainer Screw Fordson
Dexta 3/8 - 16 x 3/4



41497
Brake Drum Dexta



6928
Brake Back Plate 35 135 c/o
Shoes



1250
Brake Shoe 35 135 Rigid Lining - PAIR
** 1250R has Rubber Lining ** Lining is
1020, Rivets are J7/48



1020
Brake Lining 35 135 -
Set With Correct Rivets
Complete shoe is 1250,
Rivets are J7/48



1810029
Brake Shoe Spring Kit 35 135
(One Side) Pin Length 58mm



1885405
Brake Shoe Adjuster 135 35



825064
Brake Drum Spring 135



1850217
Brake Shoe Spring 135



41994
Hand Brake Assembly Ford
3000 3600 Dexta



41367
Hand Brake Ratchet Ford
Dexta 2000 2600 3000
Also fits 3600

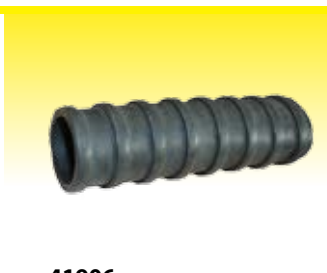

41906
Hand Brake Rubber
Fordson Dexta **And
Super Dexta**



41387
Bush Dexta Brake &
Clutch Shaft



41375
Gear Lever Boot Ford 1000
600



42020
Seal Brake Pedal Cross Shaft
Dexta



387/382
Wheel Bearings Dexta Outer
Half Shaft Bearing 2000 / 3000 /
Dexta **JCB KIT 3575**
OE Ref: 659459R1 659458R91

Brakes, Hydraulics & Linkage

Dexta Brake Parts

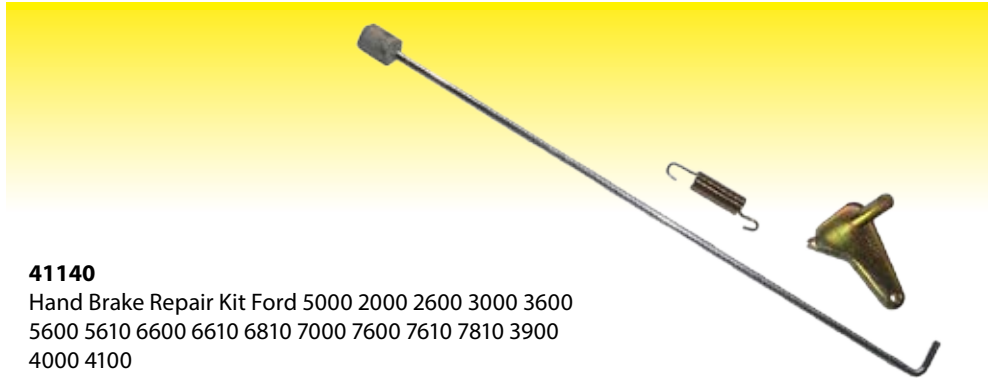

41140
Hand Brake Repair Kit Ford 5000 2000 2600 3000 3600
5600 5610 6600 6610 6810 7000 7600 7610 7810 3900
4000 4100

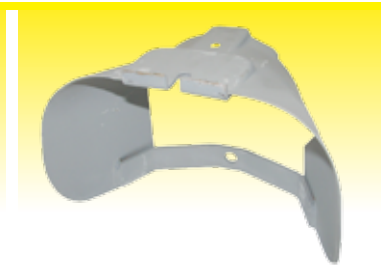

41610
PTO Guard Dexta



41786
Gear Box Cover Dexta
42046 Is Cover c/o Levers**



2826
PTO Seal Dexta &
Super Dexta
60.2 x 37.5 x 20.2mm



41519
PTO Shaft Seal
Housing Dexta



42040
Differential Lock Damper
Dexta 2000 3000

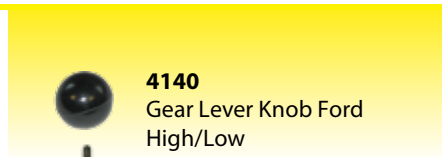

4140
Gear Lever Knob Ford
High/Low

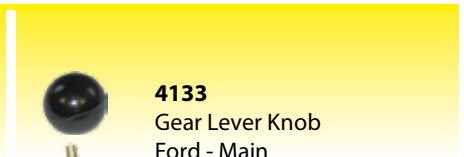

4133
Gear Lever Knob
Ford - Main



41397
Gear Lever Dexta



41525
Gear Lever
Retainer
Ford
3000 3600 3610

41755
Dexta Gear Lever - Hi/Low



42071
Gear Box
Cover
Major



4140
Gear Lever Knob
Ford High/Low

4133
Gear Lever
Knob
Ford - Main

42046
Gear Box Cover
Dexta c/o Levers
41786 Is The Cover
Knobs
4140 + 4133

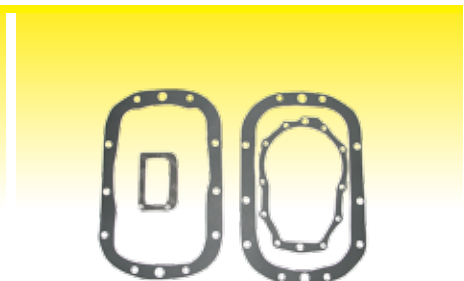







41932
Gasket Set Transmission
Fordson Dexta Fordson
Super Dexta

Brakes 2/3/4/4600/5/7600/7610

	BRONZE DISC	STEEL DISC	REAR 1/2 SHAFT SEALS	OTHER PARTS	OTHER PARTS	BRAKE ACTUATOR
2000 / 3000	 <p>2361 Brake Shoe Ford - Per Pair Square</p> <p>2562 2/3/36/3610 Brake Shoe Kit Round TYPE</p> <p>1810029 Brake Shoe Spring Kit 35 135</p>			 <p>4074 Half Shaft Seal Ford 2000 3000 Outer 98x80x13</p> <p>51991 Outer Half Shaft Seal Dexta Super Dexta 3.125 x 4.00 x 0.500</p>	 <p>4075 Half Shaft Seal Ford 2000 3000 Inner 70x50x12.5</p>	
4000 / 4600	 <p>4070 Brake Disc Ford 4000 4610 Bronze 6 Per Tractor</p>	 <p>4071 2 Per Tractor</p>	 <p>140mm 84mm 41mm</p> <p>4076</p>	 <p>884791 Bearing 165 188 Outer Half Shaft 67 X 110 X 24</p>	 <p>1881951 Epicyclic Bearing 178 188 Inner</p> <p>3845 Half Axle O Ring Ford 6600</p>	 <p>4653 Brake Actuator Assembly Ford 4000</p>
5000 / 7600	 <p>4072 (8 Per tractor)</p>	 <p>4073 (4 Per tractor)</p>	 <p>4077 Up to '86</p> <p>2763 '86 on</p>	 <p>1860503 Half Shaft Bearing 590 Outer / 7840</p>	 <p>3845 Half Axle O Ring Ford 6600</p>	 <p>1845 Brake Actuator Ford 6710 7710 Carlisle</p>
7610	 <p>404216 10'S Bronze Brake Disc (8 per tractor)</p>	 <p>2268 7610 Steel Disc To Suit 4216 (4 Per tractor)</p>	 <p>160mm 90mm 39mm</p> <p>4077 Up to '86</p> <p>2763 '86 on</p> <p>156mm 86mm 32mm</p>			 <p>1845 Brake Actuator Ford 6710 7710 Carlisle</p>

Brakes, Hydraulics & Linkage

Brakes 7840/TW/60/TM/M/

<p>7840</p>	<p>404216 Brake Disc 7840 TS Bronze - Meritor (8 per tractor)</p> 	 <p>402949 Brake Disc Intermediate Ford 7840 TS Steel</p>	 <p>3845 Half Axle O Ring Ford 6600</p> <p>2060 ID 101mm or</p>  <p>1860503 Half Shaft Bearing 590 Outer / 7840</p> <p>41005 ID 89mm OD 123MM</p>	<p>43448 Half Shaft Bearing Inner Ford 5640 6640 7740 7840 8240 8340 TS100 TS110 TS115 TS90 TU140 Rear Axle</p>  <p>43448 Bearing Rear Axle Inner</p>	<p>401101 Brake Actuator Assembly Ford 40 / TS 5640 6640 7740 7840 8240 8340 TS90 TS100 TS110 TS115</p> 
<p>TW G 30</p>	 <p>2776 Brake Disc Ford TW 2 per tractor</p>	 <p>2060 ID 101mm</p>	 <p>4082 TW Ware Plate For Brakes</p>	 <p>2777 TW Brake Piston Seal (Large)</p> <p>2778 Tw Brake Piston Seal (Small)</p>	
<p>60/TM/ M'S</p>	 <p>41896 Brake Disc Ford TM120 130 140 155 Heavy Duty</p> <p>41038 Brake Disc Ford 60 TM M Fiat F</p>	 <p>409672 Ford 60 TM110-165 Pressure Ring for brake in rear axle (Also fits F100-140)</p>		 <p>41040 Ford 60's/TM/M/Brake Disc O Ring</p>	 <p>41039 Ford 60's/TM/M/Fiat F's Brake Disc O Ring</p>
<p>T6000 TSA</p>	 <p>43010 Brake Disc Ford New Holland TS100A TS110A TS115A TS125A TS135A TS100A Delta TS110A</p>	 <p>42999 Piston Brake New Holland T6000 TSA</p>		 <p>41040 Ford 60's/TM/M/Brake Disc O Ring</p>	 <p>42998 Small Seal Brake New Holland T6000 TSA</p>

Brakes 7840/TW/60/TM/M/

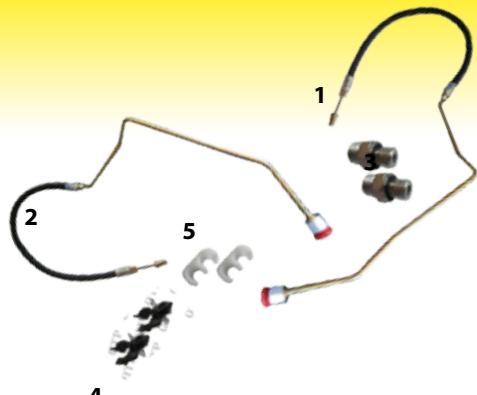

43232
Brake Line Pipe Kit Ford TM175 TM190 Case MXM175
MXM190 OE Ref: 87301553

1	43227	Brake Line Ford RIGHT HAND	87301553
2	43228	Brake Line Ford LEFT HAND	OE87301552
3	43229	Connector Hydraulic Ford	OE 82019693
4	43230	Hose Clip Ford	OE 82038909
5	43231	Hose Clip Ford TM175 TM190	OE 82035645



42121
Brake Master Cylinder Ford TM175
TM190 Also fits Case MXM175
MXM190 With PRV



43042
Hose Brake Line Ford TMs TSs
TLs TNs



43066
Rear Outer Wheel Bearing T6
T7 TM F M

4284
Repair Kit Ford
TW Brake Master
Cylinder



41791
Brake Kit Ford 40 -
With Slots



43010
Brake Disc Ford New Holland TS100A
TS110A TS115A TS125A TS135A TS100A
Delta TS110A
Delta TA115A Delta TS130 Delta



43120
Brake Disc Ford 3010S 4010S 5010S
3830 4030 4230 4430 3435 3935 4135
TD55D-TD90 TD90D TD95 TD95D Fiat
66 76 86 Series



T 6000 - T7

T 7510 - T 7550



43641
Brake Disc New Holland T6000 Series T7
Series OE Ref: 87397895



43467
Brake Disc T7510 T7520 T7530
T7540 T7550 OE Ref: 87723854



53786
Disc Hand Brake T7500s
OE Ref: 87723855

T7 Rear Axle Transmission Brakes

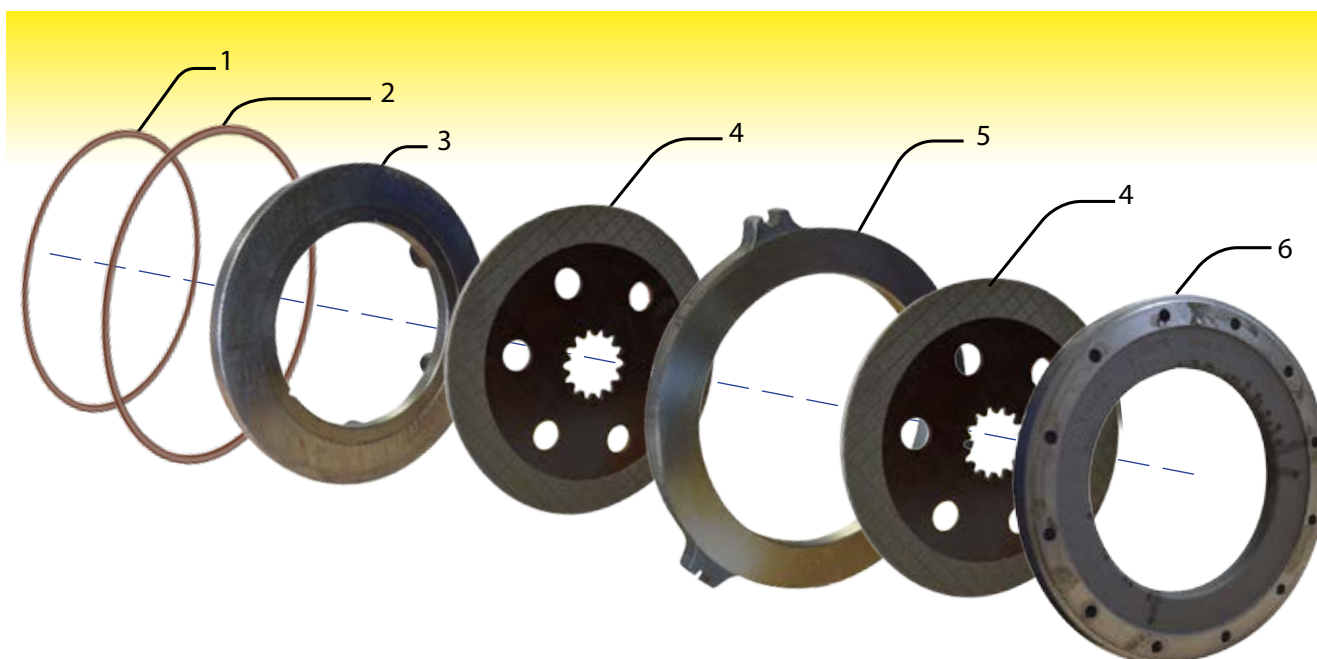

1	43566	Brake Seal T7 220 250 260 235 270 245 230 T7030 - T7070 TM175 TM190 Steyr 6205 6185 6170 6215 6230	OE REF: 5195253
2	41040	Brake Disc O Ring Ford 60 TM M Fiat F's Large	OE REF: 5165512
3	43562	Brake Piston New Holland T7 220 235 250 260 270 T7030 40 5 060 70 Steyr 6185 6205 6170 6215 6230	OE REF: 5195093
4	43565	Brake Disc New Holland TM175 TM190 T7030 T7040 T7050	OE REF: 47126358
5	43564	Brake Ware Plate New Holland T7 220 230 250 T3040 T7040 T7050 T7060 TM175 TM190	OE REF: 5185950
6	43563	Brake Piston New Holland T7 220 230 235 245 260 T7030 40 50 60 TM175 TM190	OE REF: 5185968

Front Axle Brake Disc



43571
Front Brake Discs New Holland
TM150 TM155 TM165 TM175
TM190 T7000 Series T7 Series
OE Ref: 5178903

Brake Housing

43516
Brake Housing T6000s T7s
RIGHT HAND
OE Ref: 87683203

43515
Brake Housing LEFT HAND
OE Ref: 87683204



4WD Steel Plate



43613
Steel Plate New Holland T6 T7 4WD
** 52317 is Clutch Disc ** 7 per Tractor
OE Ref: 84177629



52317
Clutch Plate Disc Case IH 4WD / PTO
OE Ref: 5163844



Brakes, Hydraulics & Linkage

Date:..... No. of Pages:.....

Name of the Rep..... A/C Number:.....

From:..... e-mail.....

Phone No.:..... Fax No.:.....

Please quote for the following parts - Quotation Number :

I wish to confirm the following order on Quotation Number:

Please supply the following parts:

Qty	Part No.	Description	Unit Price
1.			
2.			
3.			
4.			
5.			
6.			
7.			
8.			
9.			
10.			
11.			
12.			
13.			
14.			
15.			
16.			
17.			
18.			
19.			
20.			
21.			
22.			
23.			
24.			

Please photocopy this page

Please do not remove this page

Comments:

Customer Signature:

Rep's Signature:











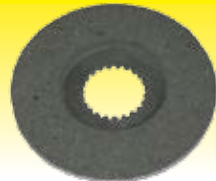

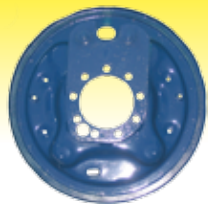
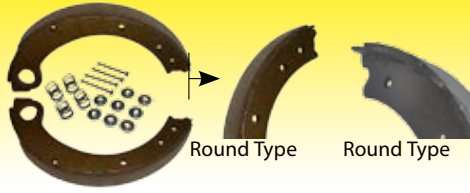

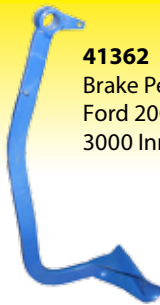
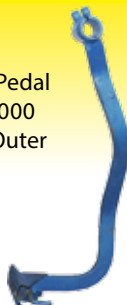
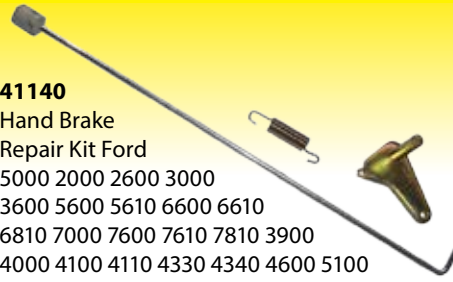

Tel No: + 353 44 934 1638

e-mail: info@qtponline.com, www.qtponline.com

Page of

Brakes, Hydraulics & Linkage

2/3000 Brakes

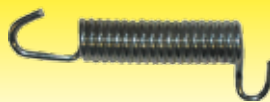
 <p>409874 Hand Brake Actuator (for Disc 4120) 2100, 2110, 2120, 2150, 2300, 231, 2310, 233, 333, 3330, 335, 340, 3500, 3550, 3600, 3900,</p>	 <p>4120 Hand Brake Disc Ford - All Models 5000 6600 2100, 2110, 2120, 2150, 2300, 231, 2310, 233 2600, 3000, 3055, 3100, 3120, 3150, 3300, 331</p>	 <p>4132 Brake Drum Ford 2000 3000 - Late Type</p>	 <p>41582 Grommet Ford 2000 3000 3600 Brake Adjuster</p>	 <p>4716 Brake Backing Plate Ford 2000 3000</p>
 <p>2361 Ford 2/3/36/3610 Brake Shoe Kit Square Type 2562 Ford 2/3/36/3610 Brake Shoe Kit Round Type 1810029 Brake Shoe Spring Kit 35 135</p>	 <p>42041 Hand Brake Rod 3000</p>	 <p>42042 Hand Brake Assembly Ford 5000 Early Majo</p>	 <p>41994 Hand Brake Assembly Ford 3000 3600 Dexta</p>	
 <p>41990 Clutch Pedal Ford 2000 3000</p>	 <p>41362 Brake Pedal Ford 2000 3000 Inner</p>	 <p>41363 Brake Pedal Ford 2000 3000 Outer</p>	 <p>41140 Hand Brake Repair Kit Ford 5000 2000 2600 3000 3600 5600 5610 6600 6610 6810 7000 7600 7610 7810 3900 4000 4100 4110 4330 4340 4600 5100 7100 7200</p>	
 <p>41935 Brake Pull Rod Ford 2000 3000</p>	 <p>41431 Hand Brake Ratchet Ford 2,3000 26,3600,3610</p>			
 <p>41897 Bushing Hand Brake and Brakeshaft 3000 7000 4600 7810</p>	 <p>4703 Brake Pedal Cross Shaft Seal All Ford Models 39.9x27x9.5</p>	 <p>4269 Brake Return Spring Ford 2610-4610</p>	 <p>4136 Brake Pedal Return Spring Ford 3-7000 & 36-78</p>	
 <p>41466 Brake Return Spring Ford 2000 3000 3600 3610 Lower</p>	 <p>D4NN2472A Brake Pedal Return Spring Ford</p>	 <p>4488 Clutch Pedal Spring Ford 2000 TW 40</p>	 <p>41467 Brake Return Spring Ford 2000 3000 3600 3610 Upper</p>	

4/5/6000 Brakes



4653
Brake Actuator Assembly Ford 4000



1860963
Brake Actuator 165 290 Wet 50B 50B



1845
Brake Actuator Ford 6710 7710 Carlisle

1005510
Spring Brake
Actuator 165
Ford 7840
Square



4792
Brake Boot Seal Ford Wet
Ford 1000 600 10 40 TS
Doesn't fit 2000 3000



41897
Bushing
Hand Brake
& Brakeshaft
3000 7000 4600 7810



1860960
Gasket Boot Sealing Housing



C5NN4N001A
Lock Nut Ford 26/3600
Bearing

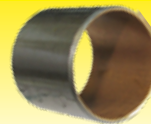

41992
Brake Pedal Bush Ford
5000 6600 6610 Inner
Diameter: 25.07mm Outer
Diameter: 27.02mm



41993
Bush Ford 5000 6600 6610
Brake & Clutch Shaft



43307
** USE 41446 ** Rod Brake Actuator Ford
5610 6610 7010 7610 7710 8010 5900
5640 6640 7740 7840 8240 8340
OE Ref: 83972123



41471
Brake Rod Ford 5000 6600 7600
1/2" UNF Thread



42279
Brake Pull Rod Assembly Ford 5000
- 6600

43309
Nut Brake Rod Ford
5610 6610 6810 7610 7710
7810 7910 8010 8210 5600 6600 7600
5000 TS100 TS110 TS120 TS90
OE Ref: 81836755



41446
Foot Brake Pull Rod Ford 4000 4600



41531
Brake Pedal Shaft Ford 5000 - 7000 5600
- 760 5610 - 7810

43312
Spring Brake Pedal Ford
5640 6640 7740 7840 8240 8340 TS100
TS110 TS80 TS90 OE Ref: 81870326



4136
3/4/5/66/76/7810 Brake Return
Spring-(155Mm)



41466
2/3/36/3610 Lower Brake Return
Spring



4269
2/3/4/5/76000 Brake Return
Spring



D4NN2472A
2/3/4/5/7600 Brake
Return Spring (80 Mm)



4488
2/3/4/5/66/7610/7840/8730/
TS/TW Clutch Pedal Spring

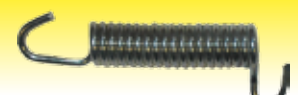

41467
2/3/36/3610 Upper
Brake Return Spring

Brakes, Hydraulics & Linkage

Brakes

Q Cab Single Cable Type

Super Q/AP Cab Dual Cable



4025 Hand Brake Cable Ford 2310 - 8210 Q Cab

1295 Hand Brake Cable Ford 6600 7610 Long 73" (186cm) Long
1289 Hand Brake Cable Ford 6000 7610 Short LH 37" (940mm) end to end

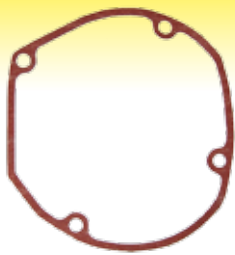

4797
 Hand Brake Housing Gasket Ford



51772
 Brake Light Switch Ford 3000 5000 Silver Contact (Super Q Cab)
 ** ON when pressed **



2831
 Hand Brake Button Assembly Ford AP Cab For Transmission



41409
 Hand Brake Light Switch Ford 40's



409717
 Switch Ford Hand Brake (Buzzer) 01-11-95 up M SERIES TL TM - 3 Wire T SERIES TLA TS TSA ** 5 Wire is 42899 **



41898
 Brake Pedal Shaft Bush Rear Axle Centre Housi 2600 3600 5600 5700 6600 6700 7600 7700 3930 4630 5030 2610 3610 4610 3000 5000

42899
 Switch Ford Hand Brake T6 T7 TM TS TSA 5 Wire
 ** 3 Wire is 409717 **

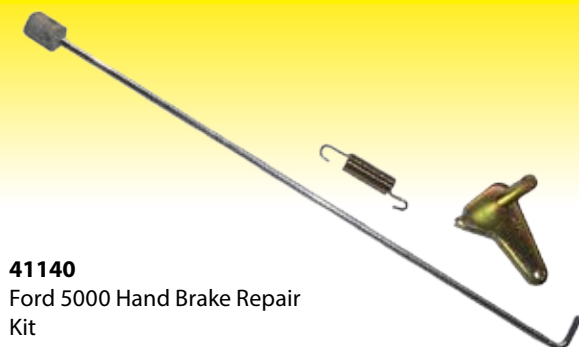

41140
 Ford 5000 Hand Brake Repair Kit



41321
 Hand Brake Assembly Ford 5000 6600

Brake Components



41551
Hand Brake Cable Ford 60 M
TM length 36"

404802
Hand Brake Cable Ford 40 TS
LH 37" Long TS90 - TS115 (RH
cable 404199) length 37"



43282
Hand Brake Cable Ford New
Holland TL100 TL60 TL70
TL80 TL85 TL90
OE Ref: 5183158

404199
Hand Brake Cable
Ford 40 TS RH 72"
Long TS90 - TS115
(LH cable 404802)
Length 72"



43195
Hand Brake Cable Ford
T6010 T6020 T6030 T6040
T6050 T6060 T6070 TS100A
TS100A TS115A TS125A
TS130A TS135A



42223
Brake Slave Cylinder Ford 40 TS
5640 6640 7740 7840 8240 8340
TS100 TS110 TS115 TS120 TS90



409869
Repair Kit Ford 40 TS Brake
Master Cylinder 5640 6640
7740 7840 8240 8340 TS100
TS110 TS115 TS90
To fit Master Cylinder 409826



409826
Brake Master Cylinder Ford 40
TS 5640 6640 7740 7840 8240
8340 TS100 TS110 TS115 TS90
Repair Kit
409869



42126
Brake Master Cylinder Ford
TM TL L M



43617
Brake Master Cylinder New
Holland T6 Series T6000 Series
TSA Series OE Ref: 47132767



43343
Brake Master Cylinder Ford T5s TD5s TLAs Case JX JXU
OE Ref: 87354681



43291
Brake Master Cylinder Ford TC52 TC54 TF76 TX62 TX64 TX65
TX66 TX67 TX68 Valmet 505 605 705 805 905 655 755 855
C100 C110 C130 C150 OE Ref: 89509901



42917
Brake Valve Booster New
Holland T7030 T7040



43273
Accumulator New Holland Brake Valve &
Transmi T7030 T6030 T6050 TM190 TS115A
TS130A TL100AT6040 T6020 TS100A TL80A
T6010 T7050 T6070 OE Ref: 5195043



42121
Brake Master Cylinder Ford TM175 TM190
Also fits Case MXM175 MXM190 With
PRV** Accumulator is 43273 **
OE Ref: 82037485

Brakes, Hydraulics & Linkage

Brake Components



42901
Brake Fluid Reservoir Ford
TM M 40 60 Series



409659
Brake Switch Ford Hi/Low
Forward / Reverse Clutch SW - Depends
on Model 30 40 60's Ford M TL TM TS



42222
Brake Light Switch Ford Super
Q Also Fits 10 30 35 TN Series

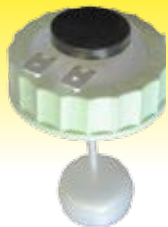

409748
Brake Reservoir Cap
Ford 40/M/TS With
Switch



43003
Brake Pipe Flexy Ford
40 Series TS



43009
Brake Pedal Spring Ford 40
Series TS No Cab



2060
Seal Half Shaft Rear Axle TW Ford 40s
ID 101 OD 134



41005
Outer Shaft Seal Ford 7840 TS



1860503
Half Shaft Bearing 590 Outer / 7840



401101
Brake Actuator Assembly Ford 40 / TS
5640 6640 7740 7840 8240 8340
TS90 TS100 TS110 TS115
Spring =1886562

1860959
Boot Seal Wet
Brakes



4792
Brake Boot Seal Ford
Wet Ford 1000 600
10 40 TS 40
Doesn't fit 2000 3000



409750
Wheel Nut Ford 40 M TS
Rear 3/4" UNC (8 per Hub)



409749
Washer Ford 40 M TS Wheel Rear
*** 8 Per Hub ***



1886562
Spring Brake Actuator Round also
fits Ford 40s L TC TS OE Ref: 1886562



409784
Brake Pedal Spring Ford 35
40 TS TL 60



409782
Seal Ford 40 TS Brake Slave
Cylinder

Dexta/Major Lift Cover Parts

41479
Hydraulic Middle Arm Super Major



41478
Hydraulic Lift Shaft Super Major



41441
Bushing Hydraulic Lift Shaft Major-Steel



41449
Seal Brake Cross Shaft Super Major
28x45x10



41440
Bushing Hydraulic Lift Shaft Major - Brass
** 41441 is Steel **



41436
Hydraulic Top Cover Arm Major



41430
Hydraulic Pump Shaft Ford 4 Cylinder



41481
Lift Cylinder c/o Control Valve Major



41482
Hydraulic Piston Major 85mm



41445
Hydraulic Control Valve Major Super Major



41453
Hydraulic Piston Seal Super Major



41457
Hydraulic Piston Seal Dexta

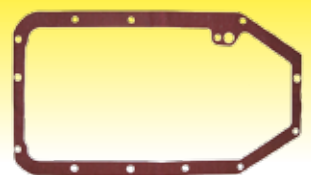

41465
Lift Cover Gasket Major

Hydraulic Pumps

 DYNAMATIC
LIMITED UK



4065
Hydraulic Pump Ford 4000
Gasket=2384



4065R
Hydraulic Pump Ford 4000
** Gasket is 2384 **OE Ref:
81824183



43138
Drive Gear Hydraulic Pump
Ford 3000 4000 5000 7000



43139
Drive Gear Hydraulic Pump
Ford 3000 4000 5000 7000

 DYNAMATIC
LIMITED UK



4066
Hydraulic Pump Ford 5000
Gasket=3388



4066R
Hydraulic Pump Ford 5000
OE Ref: 8182398381823983



4068R
Hydraulic Pump Ford
4600 5030 OE Ref:
8393658583936585

Hydraulic Pumps

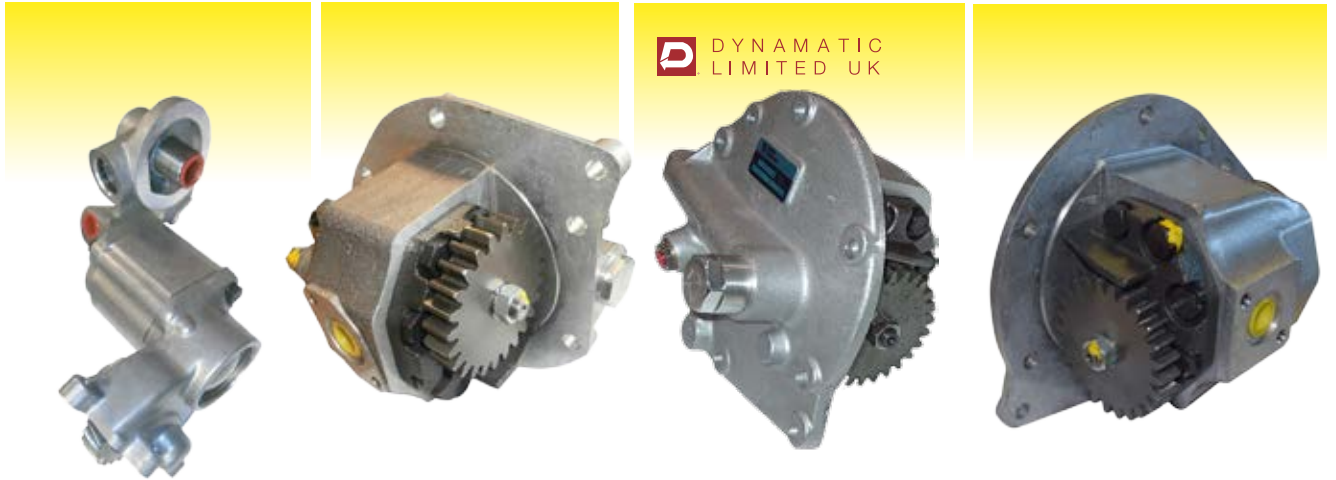

D DYNAMATIC LIMITED UK

2138R
Hydraulic Pump Ford 6610
7610 Eng Mounted 2000
3000s Gasket 3240 OE Ref:
83996272 E1NN600AB

4067R
Hydraulic Pump Ford
5000 7000 Dual Power

Seal Kit 53440

4069
Hydraulic Pump Ford 6600
7600
Dual Power & Non Dual
Power
Gasket=3861

4069R
Hydraulic Pump Ford 6600 7600
OE Ref: 8390244
839082448390244

43005
Seal New Holland
2000 - 8210
Hydraulic Pump
To Backend
(Square O Ring)



D DYNAMATIC LIMITED UK



3761R
Hydraulic Pump Ford 6610 7610
8210
** Internal Seal Kit 53437**



1529
Hydraulic Pump Ford 8600 9600 9700



42076R
Hydraulic Pump Ford **TL** 70 80 90 100

Hydraulic Pumps



1340
Hydraulic Pump Ford TW5 10 15
25 35 30s (8630)



1340R
Hydraulic Pump
Ford TW Series, 30 Series
OE Ref: E2NN600BA



42269R
Hydraulic Pump TLA
OE Ref: 47129338



43633
Hydraulic Pump Ford 35 Series TL TLA
OE Ref: 5167394



43336
Hydraulic Pump Ford T4000S
T4000 Deluxe T4000F T4000N
T4000V TD5000 TD7 OE Ref:
87472286



404770R
Hydraulic Pump Ford 7840 SL Dual
Power 5640 6640 7740 8240 8340
TS100 TS110
OE Ref: 81871528



42011
Hydraulic Pump Ford TM115 TM125

O Ring=43103



42975
Compensator Valve Hydraulic
Pump Ford TM115 TM125
TM115 TM120 TM125 TM130
TM135 TM140

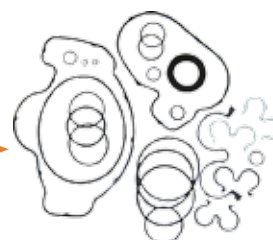

42881
Seal Kit for 42011 + 42056

Hydraulic Pumps



43632
Hydraulic Pump New Holland T6000,
TSA, T6 Series
Case Maxxum MXU 80L/MIN
OE Ref: 0517625308



43634
Hydraulic Pump New Holland T6070
T6050 T6080 Case Puma Series
OE Ref: 47135548

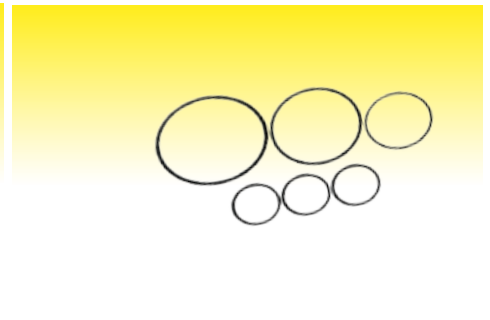

43603
Hydraulic Pump Seal
Kit T6/T7/T6000/T7000
Series
OE Ref: 87705156



43290
Hydraulic Pump New Holland T6050 T6020 T6030 T6040
T6010 T6060 T6070 T7030 T7040 T7050 T7060 TM175
TM190 TS135A TS100A TS115A TS125A
OE Ref: 5198694

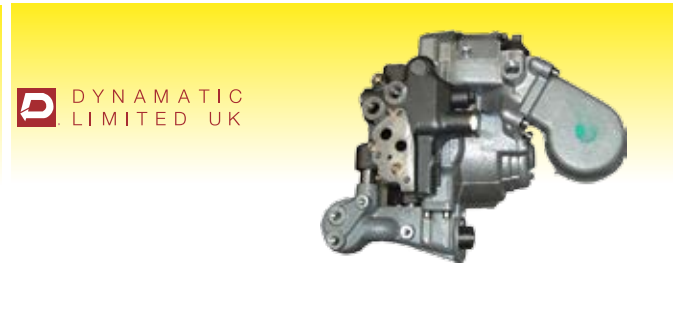

4783
Hydraulic Pump New Holland 40 TS SLE
Gasket=3862
Pump Shaft=409780
Seal Kits=404605 & 409779
O Ring=409810
Power Steering Section=403961

Power Steering Pumps



42056
Power Steering Pump
TM115 TM125



404897
Auxiliary Pump Ford 40
Non SLE

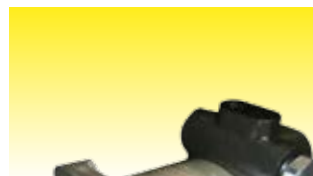

43283
Power Steering Pump Ford
4635 4835 5635 6635 TL100
TL65 TL70 TL80 TL90 Fiat L60
L65 L75 L85 L95
OE Ref: 82991210

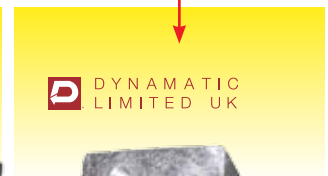

403961
Power Steering Pump
Ford 40 TS SLE

42881
Seal Kit for 42011 + 42056

Hydraulic Parts



3029G
Quick Release Coupling Spool Valve Ford



41919
Spool Valve Cover Ford
10's 40's 60's TS TW

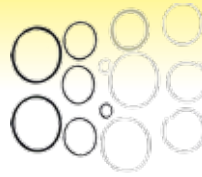

51355
Seal Kit to Suit 3029G
Ford Coupling



42094
O Ring Outer Small Ford for
3029G & 6116 10s 30s 40s
60s 70s TM TS TW 7630



42276
Valve Hydraulic Changeover Ford 6610

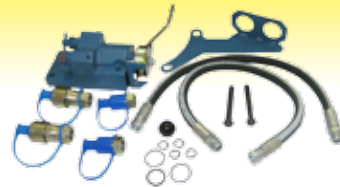

42275
Valve Hydraulic Changeover Double
Ford 5000

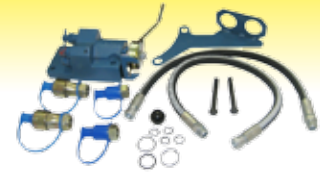

42274
Valve Hydraulic Changeover Single
Ford 3000



3045G
Pipe Ford 6610 7610 Oil
Supply to Solenoid Va



3553
Olive for 3045G



43196
Valve External Service Ford 3000 4000 [OE Ref: 81815906](#)



41926
Centre Housing Dipstick Ford 10's



4166
Transmission Oil Filler Cap Dipstick Ford



1273
Sleeve Ford 7610 Hydraulic Filter Bypass

Hydraulic Parts

4313
Priority Valve Spool Ford 10
Genuine



1281
Priority Valve Ford 6610 7610 40
TS ***Does Not Include 4313 Valve
Spool *** OE Ref: 83949225



42268
O Ring
Hydraulic Ford
1.125" x 1.03"

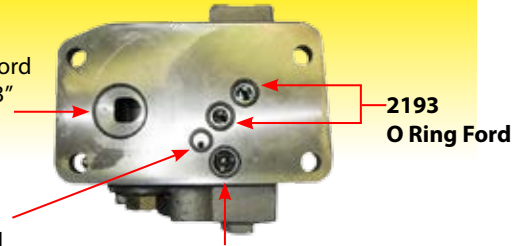

409894
O Ring Ford
40 TS

42267
O Ring Hydraulic Ford 0.614"
x 0.070"

41633
Quick Release Coupling Ford TS TM
60 M22



6116
Quick Release Coupling 300 3000 M22
Also for John Deere Ford TS TM 60



53488
Quick Release Coupling Hydraulic 1/2
Female M22 x 1.5 Thread 75mm Long



41778
Hydraulic Arm Ford 4000 LH - 48
Splines



41777
Hydraulic Arm Ford 4000 RH - 48
Splines

43337
Lift Arm Ford LH 4630 3930 4130 4830
5030 391 2810 4110 4610 4600 3600
OE Ref: D3NNB921A



43338 Lift Arm Right Hand
OE Ref: D3NNB920A

41434
Hydraulic Top Cover Arm Ford 2000
3000 3600 3610 RH - 45 Spline RH



41435
Hydraulic Top Cover Arm Ford 2000
3000 3600 3610 LH



41757
Filler Cap Ford - Transmission



409754
Coupling Hydraulic Lift Shaft Ford TS
TW



2198
Linkage End Ford Hydraulic Spool
Valve

41368
Lift Cylinder Relief Valve
Ford 4000 5000 660 Also
Fits 6600 7000



53188
Relief Valve Hydraulic Fordson
8N

4965
Top Link Rocker Ford
2000 3000 Also fits Dexta
Super Dexta



43294
Plunger Draft Control Ford 2610
2810 2910 3610 3910 4610 2600
3600 4600 2310 3230 3430 3930
4130 4630 4830 5030 231 233 234
333 334
OE Ref: 81801588



43295
Yoke Draft Control Ford 2610
2810 2910 3610 3910 4610 2600
3600 4600 2310 3230 3430 3930
4130 4630 4830 5030 231 233
234 333 334
OE Ref: 81815672



Brakes, Hydraulics & Linkage

Hydraulic Parts Spool Valves

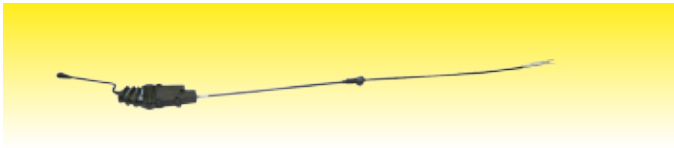

42037
Spool Valve Cable Ford 60 Series TM Cranked Lever

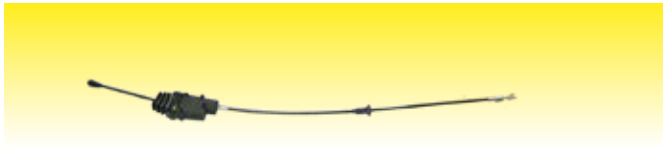

42036
Spool Valve Cable Ford 60 Series TM Straight Lever

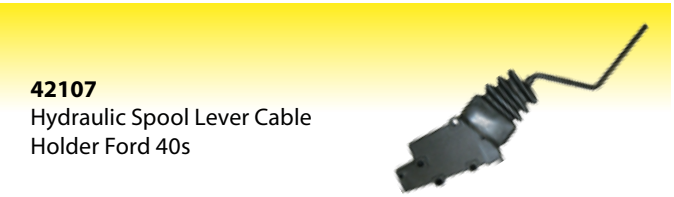

42107
Hydraulic Spool Lever Cable
Holder Ford 40s

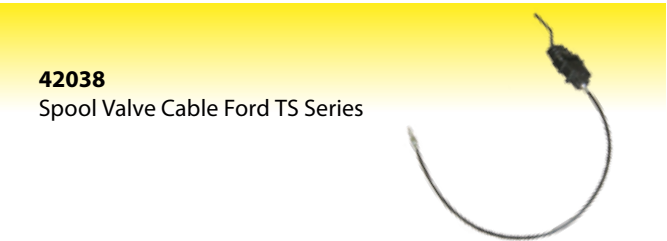

42038
Spool Valve Cable Ford TS Series

Compensator Valves



42975
Compensator Valve Hydraulic Pump
Ford TM115 TM125 TM115 TM120
TM125 TM130 TM135 TM140



43627
Compensator Valve New Holland
T6 T7 Hydraulic Pump [OE Ref: 84209779](#)



43664
Compensator Valve New Holland
T6000 Series T7050 T7040 T7030
[OE Ref: 47127261](#)

Hydraulic Valve Sections

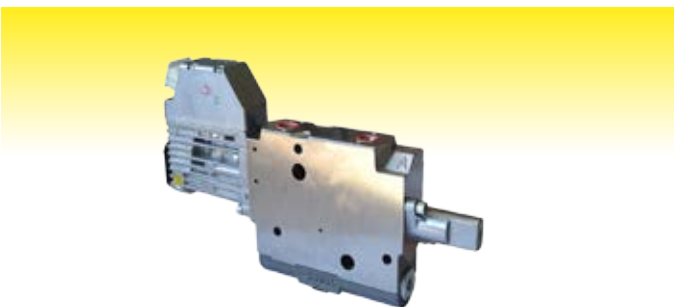

43601
Hydraulic Valve Section New Holland T6s TSAs
[OE Ref: 84125295](#)



43631
Hydraulic Valve Section New Holland TM T7 Case MXM Puma
[OE Ref: 5195165](#)

Hydraulic Parts

4146
Hydraulic Pump
Suction Filter
Ford 3000



2789
Hydraulic Pump
Suction Pipe Ford
5000



41585
Hydraulic Lever
Grommet Ford 3000-
5000



41584
Hydraulic Valve O
Ring Kit Major Ford
2-6600



41586
O Ring Seal Kit for
Blanking Plate Major
2/26/3/36/4/46/5/56
/66/7/7600



41960
Knob 3 Way
Valve Dexta



41583
Damper Valve Knob Major
Ford 2600 - 6600



42905
Shaft Hydraulic
Pump Ford
10 Series



409781
Control Valve Oil Seal
Ford 40's/TS



409780
Shaft Hydraulic Pump
Ford 40's/TS ** 4783
is Hydraulic Pump **



43177
Hydraulic Lift Shaft Ford 5110 5610 6410
6610 6710 6810 7410 7610 7710 7810 7910
8210 5600 5700 5900 6600 6700 7600 7700
5000 5100 5200
[OE Ref: C5NN544B](#)



41330
Hydraulic Lift Shaft Ford 2000 2600 2610
3600 Also fits 3610 Dia. 50.70 46 Teeth



42937
Hydraulic Arm Centre
2000 3000



Hydraulic Parts

O Rings



409810
Hydraulic Pump O-Ring
Ford 40's/TS (Large) **
Kit 404605 **



409619
O Ring for Ford
hydraulics 15.85 Inner
Diamet

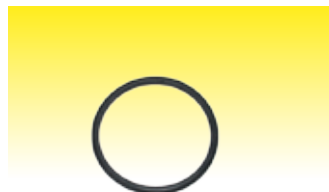

409811
Hydraulic Pump Inlet
Tube O Ring Ford 40 TS



409743
Lift Cover O Ring Ford 40's

409738
Ford 40's O Ring



409759
Hydraulic Lift Cover Shaft
Seal Ford 40/TS



42267
O Ring Hydraulic Ford
0.614" x 0.070"



42268
O Ring Hydraulic Ford
1.125" x 1.03"



BS334
50B Spool Valve 'O' Ring

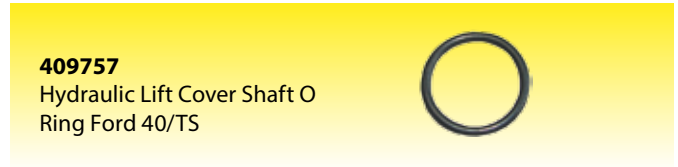

409757
Hydraulic Lift Cover Shaft O
Ring Ford 40/TS

Hydraulic Pump Seal Kits



41829
Hydraulic Pump Seal Kit
Dexta & Major



41165
Hydraulic Pump Seal Kit
Ford 6610-8210



409779
Hydraulic Pump Seal Kit
Steering Section
Ford 40 & TS



404771
Hydraulic Pump Seal Kit
Ford 40 SL
Pump - 404770

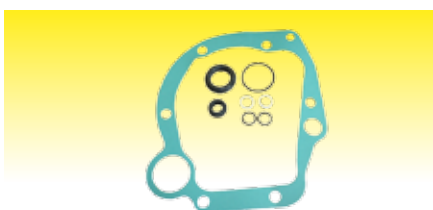

404605
Hydraulic Pump Seal Kit
New Holland SLE



42881
Seal Kit
TM Series
Pumps - 42011 42056



42061
Hydraulic Pump Seal Kit **8430 8630**
TM115 TM120 TM125 TM130 TM140
390 4255 4260 4265 4270

Hydraulic Parts

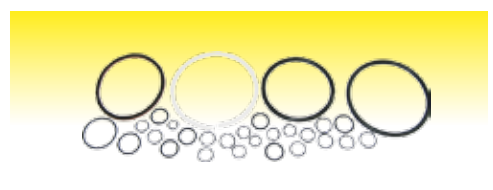
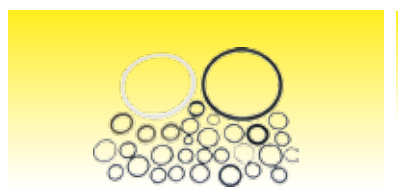
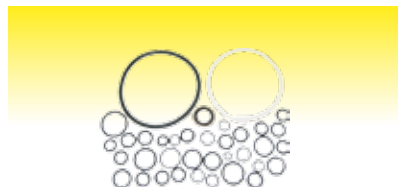
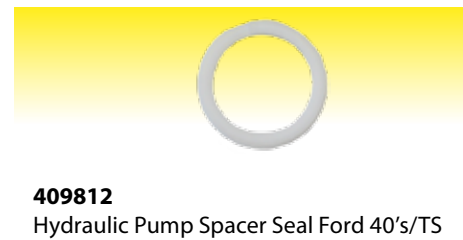
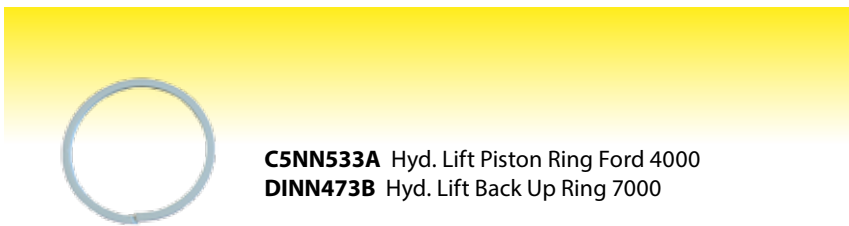
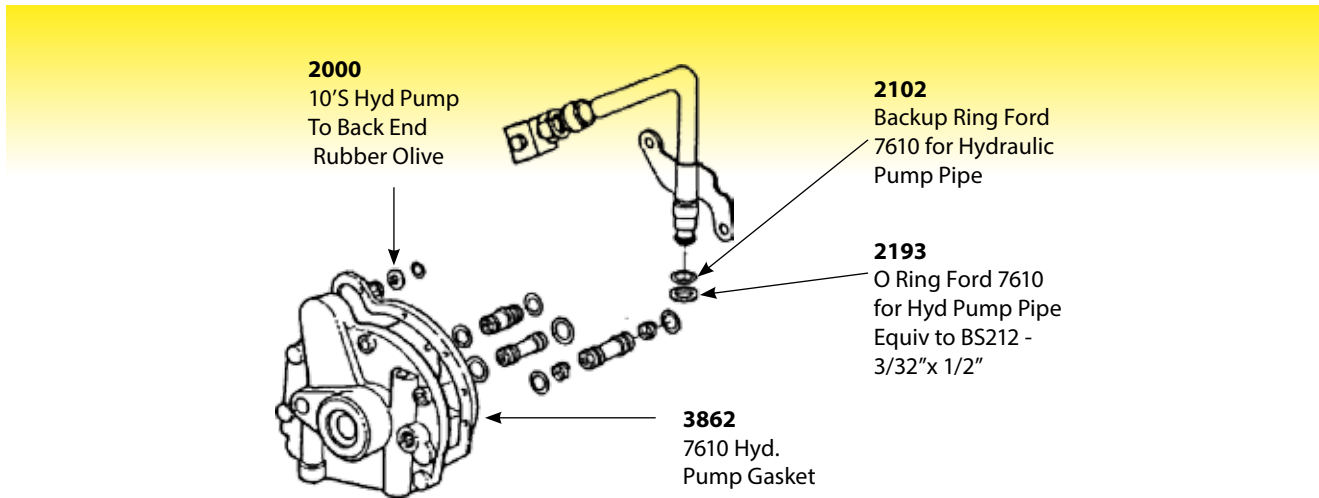

Hydraulic Parts



43306
Cross Shaft Hydraulic
Ford 5610 6410 6610
6810 7010 7610 7710 8010 TS100
TS110 TS115 TS80 TS90 7630
OE Ref: 83952650



43321
Lift Pin Hydraulic Lift Cylinder
Ford 5110 5610 6410 - 6810 7010
7410 - 7710 - 7910 8010 5600 5700
5900 6600 6700 7600
OE Ref: C7NN526D



43326
Lift Arm Hydraulic Ford 5110 5610 6410 6
610 R6710 6810 7410 7610 7710 7810 79
10 8210 5600 5700 5900 6600 6700 7600
7700 5000 5100 5200 7000 - 7200 5340
OE Ref: 81802019

43327 Lift Arm Hydraulic Ford
5110 5610 6410 6610 L
OE Ref: 83952857



63.6 x 73 x
64.5mm

43317
Bush Hydraulic Lift Shaft
Ford 5110 5610 6410 -
6610 6710 6810 7410 7610 7710 5600
5700 5900 6600 6700 7600 7700 5000
5100 5200 7000 7100 OE Ref: 83933328



73 x 64 x
68mm

43316
Piston Hydraulic Cylinder Ford 4.125"
5110 56 6610 6710 6810 7010 7410 7610 7
710 7810 7910 8010 8210 5600 5700 5900
6600 6700 7600 7700
OE Ref: D5NN530A



43303
Washer Hydraulic Piston
Ford 5110 5610 6410
OE Ref: 81838586



43320
Lift Arm Hydraulic Ford
5610 6410 6610 6810
7010 7610 7710 8010 5640 6640 7740
7840 8240 TS100 TS110 TS115 TS80
TS90 7630 OE Ref: 81865123

Left Hand Side or Right Hand Side

43315
Piston Hydraulic Cylinder Ford
5600 5700 6600 6700 7600 7700 5000
5100 5200 7000 7100 7200 5340 3.75"
(95.25mm)
OE Ref: 81846066



43319
Seal Ford Top Arm 7810 7910 8210 5600 5700 6600 6700
7600 7700 5000 5100 5200 7000 7100 8030
OD : 82 - 3,228" OE Ref: C5NNC944A



Hydraulic Parts

HYDRAULIC POWER LIFT COMPONENTS

T7040 T7030 T7050
T7060 T7070 TM175
TM190

STEYR 6205CVT 6185CVT 6170CVT
6215CVT 6230CVT

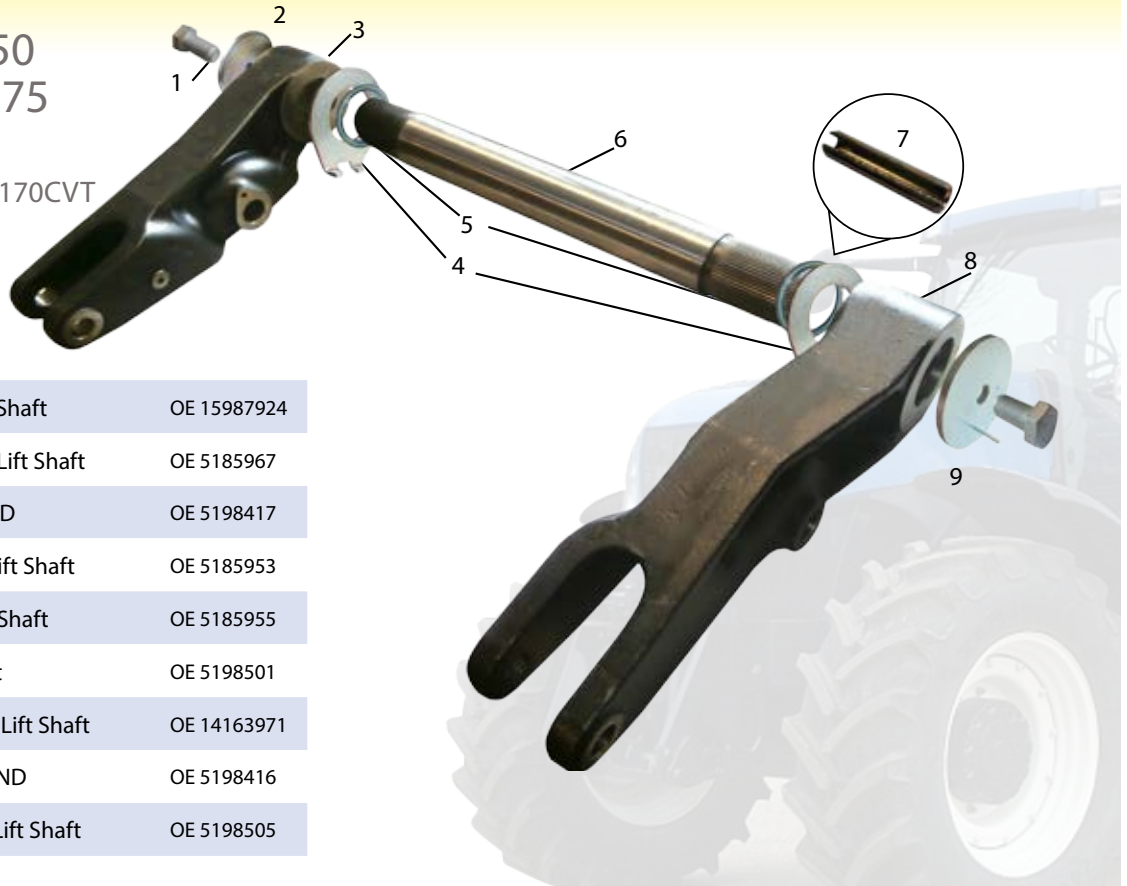

1	43454	Bolt Hydraulic Lift Shaft	OE 15987924
2	43455	Washer Hydraulic Lift Shaft	OE 5185967
3	43451	Lift Arm LEFT HAND	OE 5198417
4	43456	Spacer Hydraulic Lift Shaft	OE 5185953
5	43457	Seal Hydraulic Lift Shaft	OE 5185955
6	43450	Hydraulic Lift Shaft	OE 5198501
7	43458	Lock Pin Hydraulic Lift Shaft	OE 14163971
8	43452	Lift Arm RIGHT HAND	OE 5198416
9	43453	Washer Hydraulic Lift Shaft	OE 5198505

7603

Bush Lower Link Sensing Shaft Fiat
115-90 11590DT 130-90 140-90 160-90
180-90 1880 M100 M115 M135 F100DAL
F100FINO F110 F115 OE Ref: 5131745

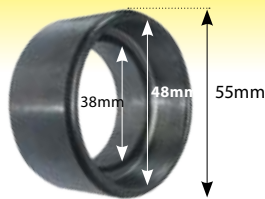

43052

Seal Hydraulic Cross Shaft Ford TM140 Fiat
115/90 OE Ref: 5131746

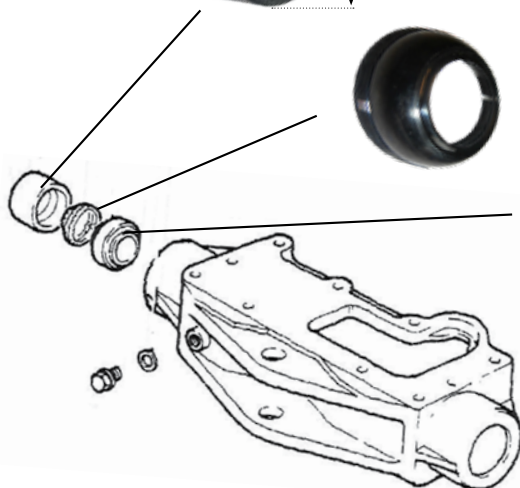

7619

Bearing Fiat M100 M115 M135 F100DAL
F100FINO F110 F115 F120 F130 F140 Ford
TM110 TM115 TM120 TM125 TM130 TM135
TM140 TM150
OE Ref: 5150443

Brakes, Hydraulics & Linkage

40's Hydraulic Components

409716
Lift Switch
Ford 40 2
Position Fast
Raise



409657
Hydraulic Oil Filter
Restriction Indicator
Ford 40 Series Switch -
Also Fits 8160 - 8560



409653
Oil Temperature
Warning Switch
Hydraulic Red Body
- High Temp (Ford
5640-8340)



409654
Hydraulic Oil Temperature
Warning Switch (Black Body-
Low Temp) Ford 40/60's
TS100A-135 TM110-140 Fiat
M100 - 160



409652
Hydraulic Connector Ford 40
TM (Hi Cap Pump)

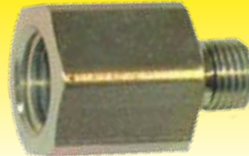

43100
Bushing Hydraulic Lift Shaft Ford T6030
T6050
TM150 TM130 8360 TM140 TM155 T6040
T6020
TM120 T6010 T6070 TS135A TS100A
TM115 TS125A



Levelling Box Parts

41670
Levelling Box
Major Solid LH



41669
Levelling Box
Major Adjustable
RH



41706
Levelling Box Y
Fork Major



42014
Levelling Box
Fork Major 1952 -
1960 Models



41709
Levelling Box Gear
For Adjustable Levelling Box

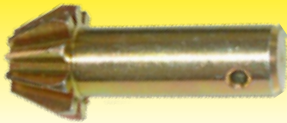

41716
Levelling Box Centre Tube
Major For Adjustable Levelling
Box



41708
Levelling Box Pin Major RH
5/8 x 117mm



41732
Levelling Box Fork
Ford 2/3000



180860
Levelling Box Pin 5/8" - Also
Ford Major 5/8 x 3.3/16 -
5/8" x 2 29/32"



41708
Levelling Box Pin Major RH
5/8 x 117mm

41711
Levelling Box Handle Clip
Major For Adjustable Levelling
Box



41712
Levelling Box Bearing
Major For Adjustable
Levelling Box



41713
Levelling Box Shaft Major
For Adjustable Levelling
Box



Levelling Box Parts



	Super Major	2/3/3600	4000	4600 / 4610	6610	7610
	1695	3360	1051R	404987	3893	2177
	184354 12"	184354 12"	184354 12"	1540		
		195457	195457	195457		
		887659	1890	1536	3446	3446
		3643	897683	4696	3424	
		1950	1950		2264	2264

Brakes, Hydraulics & Linkage

Levelling Box Parts

 <p>41550 Levelling Box Dexta LH</p> <p>43186 Levelling Box Lower Fork Dexta OE Ref: 890674M1</p>	 <p>41549 Levelling Box Dexta</p>	 <p>4107 Levelling Box Assembly Ford 3000 LH L.H Yoke Rod c/o Fork & Knuckle</p>	 <p>3894 Levelling Box Assembly Ford 4000 LH Replacement</p>	 <p>3923 Levelling Box Assembly Ford 6610 LH c/o & Fork & Knuckle</p>
 <p>43055 Levelling Box Ford TM115 TM120 TM125 TM135 TM140 TM155 TM165</p>		 <p>43056 Levelling Box Ford T7030 T7040 T7050 T7060 TM175 TM190 Case CVX180 CVX195 CVX210 CVX225 MXM175 MXM190 PUMA165 180 195 210</p>		
 <p>42053 Handle Levelling Box Fordson Dexta ** Levelling Box is 41549 **</p>	 <p>1916 Levelling Box Pin Ford 5600 7600 Upper 142mm Long 21.5 (13/16")</p>	 <p>1918 Pin Levelling Box for Assistor Ram Ford ** 1916 is Short Pin **</p>	 <p>41492 Levelling Box Handle Ford 5000 6600 6610</p>	
 <p>42118 Levelling Box Adjuster Shaft Ford 5000</p>	 <p>42119 Levelling Box Knuckle Assembly Ford 5000</p>		 <p>3898 Levelling Box Fork Ford 6610</p>	
 <p>41172 Levelling Box Knuckle Ford 4600 4610 3/4"</p>		 <p>2021 Levelling Box Knuckle Ford 5/8"</p>		 <p>4678 Levelling Box Seal</p>
 <p>41486 Pin Lower Link Ford 2000 3000</p>	 <p>41673 Pin Major Levelling Box - Short</p>	 <p>41674 Pin Major Levelling Box - Long</p>	 <p>41681 Plate to suit Major Hitch - 5 Holes</p>	

Levelling Parts 40s TS

T6000 T7



41684
Levelling Box
Ford 40 LH
Complete

41093
Levelling Box Top
Fork Ford 40's

41090
Levelling Box Top
Housing Ford 40 TS

41128
Adjuster Levelling
Box Ford 7840

41091
Levelling Box Shaft
Ford 40/TS's

41092
Levelling Box Lower Fork Ford
40 TS

41685
Levelling Box Ford
40 RH Complete
Adjustable 5640-8340
TS80 TS90 TS100 TS110
TS115

43547
Levelling Box Assembly
T6030 T6050 T6070 T6080
T6090 T7 170 175 185 190
200 210 225
OE Ref: 84293444

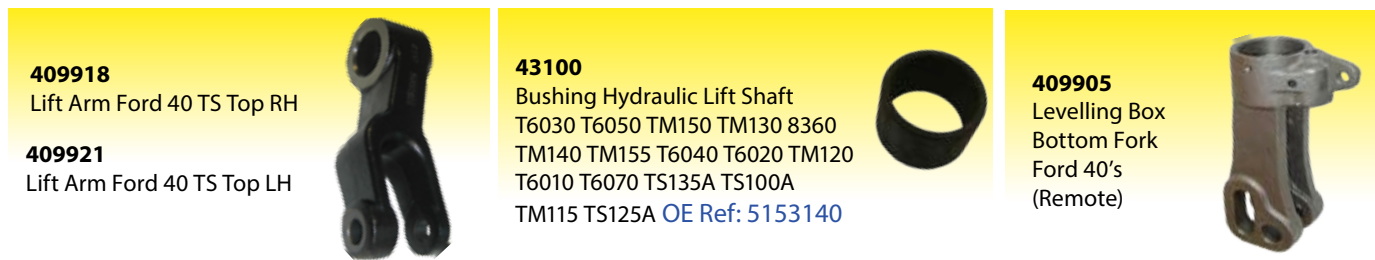

409918
Lift Arm Ford 40 TS Top RH

409921
Lift Arm Ford 40 TS Top LH

43100
Bushing Hydraulic Lift Shaft
T6030 T6050 TM150 TM130 8360
TM140 TM155 T6040 T6020 TM120
T6010 T6070 TS135A TS100A
TM115 TS125A OE Ref: 5153140

409905
Levelling Box
Bottom Fork
Ford 40's
(Remote)

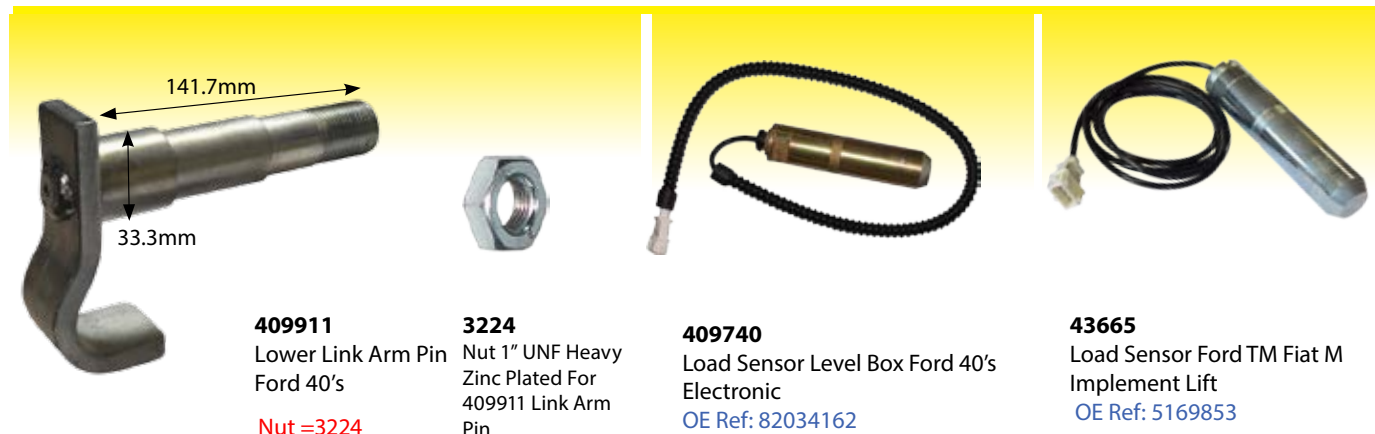

409911
Lower Link Arm Pin
Ford 40's
Nut = 3224

3224
Nut 1" UNF Heavy
Zinc Plated For
409911 Link Arm
Pin

409740
Load Sensor Level Box Ford 40's
Electronic
OE Ref: 82034162

43665
Load Sensor Ford TM Fiat M
Implement Lift
OE Ref: 5169853

Brakes, Hydraulics & Linkage

STABILISERS	Part No	Description	Cat	Min	Max	Float	Eye Bolt
 <p>380mm</p> <p> CBM SpA COSTRUZIONI MECCANICHE</p>	42258	Stabiliser T6030 T6050 TS115A TS130A T6040 TS110A T6010 T6070 TS100A T6060 OE Ref: 5197574	1	380	560		20
 <p>430mm</p>	41763	TM & 60s Heavy Duty OE Ref: 5170360	1	430	630		25
 <p>430mm</p>	41763R	Stabiliser Ford TM & 60s Normal Duty 430mm Long ** End is 51978 ** OE Ref: 5170360		430	630		25
 <p>430mm</p> <p> CBM SpA COSTRUZIONI MECCANICHE</p>	43037	Stabiliser TM115 TM125 TM135 TM150 TM165 Automatic	1	430	490		26
 <p>461mm</p> <p> CBM SpA COSTRUZIONI MECCANICHE</p>	59090	Stabiliser Automatic TM175 TM190T7030 T7040 T7050 T7060	2	461	482		36
 <p>460mm</p>	4964	Ford 4000	1	460	650	40	18

STABILISERS	Part No	Description	Cat	Min	Max	Float	Eye Bolt
	12000	Ford 40 TS 8210 Replacement (A 7/8' B 3/4') (Normal Duty)	1	470	620		20
	42257	Ford TS100 TS110 TS115 TS80 TS90 Also fits TV140 OE Ref: 82018406	1	500	740		20
	41802	Ford 5000 - 8210 Heavy Duty End is 51973	1	500	720		18
	409710	Ford 40 Series Heavy Duty End is 51973 OE Ref: 82016570	1	520	730		20
	4963	Assembly 5000 Heavy Duty Version 41802	1	540	770	40	18
	43244	Stabiliser Ford 2000 3000 3600 minimum length 430mm. maximum length 600mm	1	430	600		
	43537	Stabiliser T4000s TNs	1				

Brakes, Hydraulics & Linkage

Chain Stabilisers & Components

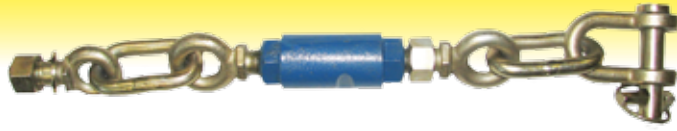

1951
Stabiliser Power Major ** D Shackle is 53202 **



53202
D Shackle for 1951



3026R Stabiliser Ford 4000 4600 4610



53203
U Bolt Suits 3026R 3025R 1635



3025R
Stabiliser Ford 5000 5600 6600 7000 7600

1168
Chain Stabiliser Tube Ford +
Weight



41821
Chain Stabiliser Ford 4000 4600 4610
4630 And 5000 5030 5600 6600 7000
7600



43345
Anchor Bracket Check Chain Ford 2000 4000 600
800 900 601 701 801 901 Dexta Super Dexta 2N
8N 9N Jubilee NAA LH [OE Ref: 957E596](#)



43344
Anchor Bracket Check Chain Ford 2000 4000
6008N 9N Jubilee NAA RH [OE Ref: 957E597](#)

Stabilisers Hangers

41359
Stabiliser Hanger
Ford 2910/3910 LH



41360
Stabiliser Hanger Ford
2910/3910 RH

41364
Stabiliser Hanger Ford
6610 7610 LH

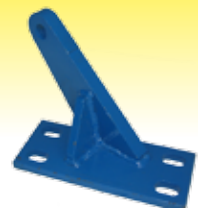

41361
Stabiliser Hanger Ford
6610 7610 RH

Stabiliser Components

52193

Clevis for 41802 Ford 5000 - 8210 Stabiliser Heavy Duty



41802

Stabiliser Ford 5000 - 8210 Heavy Duty

51973

Stabiliser End Threaded Ford 40 Series H Duty



409710

Stabiliser Ford 40 Series Heavy Duty

52194

Pin for 41763 TM & 60s Stabiliser



41763

Stabiliser TM & 60s Heavy Duty

42259

Pin Stabiliser Ford T6030 T6050 TS115A T5130A T6040 TS110A T6010 T6070 TS100A T6060



42258

Stabiliser Ford T6030 T6050 TS115A T5130A T6040 TS110A T6010 T6070 TS100A T6060

51978

Stabiliser End TM & 60 Series H Duty Length: 106mm, Dia: 25mm



43505

Stabiliser Bracket Ford T60s TSAs



7387

Stabiliser Pin Fiat 100-90 Ford 40 16mm Thick

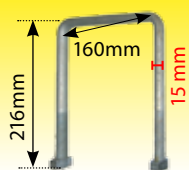

41366

6610/7610 Stabiliser Bracket U Bolt

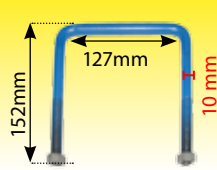

41581

U Type Bolt Ford 3000 Mudguard

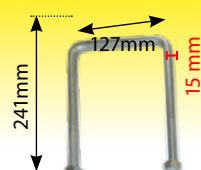

41512

U Bolt For Stabiliser Fixing Bar Ford 2910/3910/4110/4620

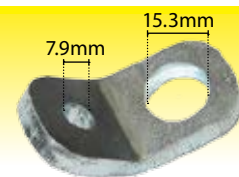

41503

Bracket Lower Link Eyebolt Ford 2000 3000 Also fits Dexta - For 41502

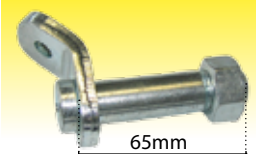

41502

Lower Link Eyebolt Dexta Ford 2000 3000

Brakes, Hydraulics & Linkage

Lift Arms



41764
Lift Arm Fordson Major



886432
Lift Arm 35 135 Dexta - Cat 1 Interchangeable



41170
Lift Arm Ford 2000 3000 2600 3600 LH

41171
Lift Arm Ford 2000 3000 2600 3600 RH



4742
Lift Arm Ford 4000 4600 4610 - 35"
34 x 3" 1/2 x 11/16" - Cat 2



4743
Lift Arm Ford 5 / 5600 35"



4920
Lift Arm Ford 6600 36" Cat 2



41443
Lift Arm Pin Dexta Lower - Short



41442
Lift Arm Pin Dexta Lower - Long



4035
Lift Arm Spring Ford 5000 7200 Lower Adjustable
Spring Spacer (500 - 720mm Adj)



7819
Spring Lower Link Restrainer Ford F140 7030 7070 TM115
TM190 Fiat 55-46 65-66 60-90 80-90 90-90 100-90 110-90
180-90



2690
Grip Pin 3mm



4219
Grip Pin 5mm

42143
Lower Link Ball Retaining Clip Ford 10 Series
100 Series 1000 Series 30 Series 40 Series
Dexta Major Super Major Super Dexta



9 Hole Bars & Drawbars

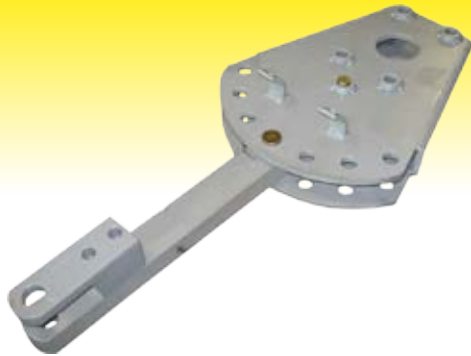

62543
Swinging Drawbar TEF 20 Dexta



41432
Swinging Drawbar Assembly
Ford 2000 3000 2600 3600



4171
Swinging Drawbar Ford 2000 3000 3600 3610
30mm x 60mm - & Clevis Pin



4206
Drawbar Assembly Ford 5000
6600 6610 Swinging

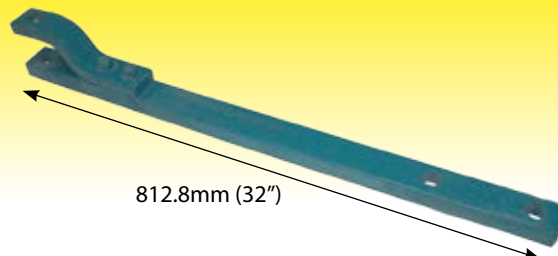









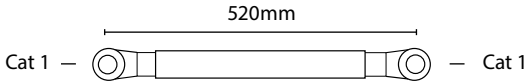

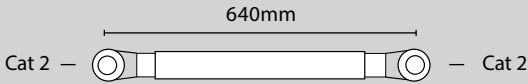

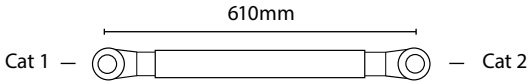

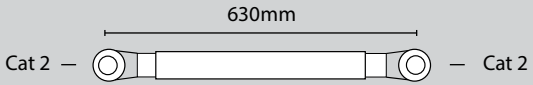
4172
Swinging Drawbar Ford 5000 6600 6610 & Clevis
& Clevis Pin

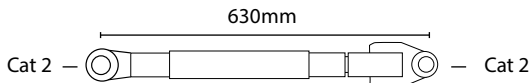

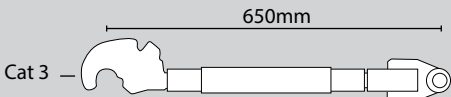
180485
Drawbar 35 135 Cat 1 9 Hole 765mm Centres **
3145 is CAT2 ** 800mm Centre to Centre
3145
Drawbar 9 Hole Cat 2 Centres 775mm

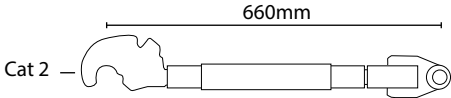
Top Links

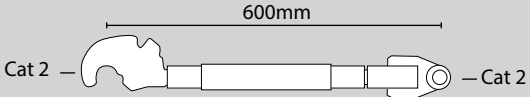
	<p>1690 Top Link 16" Cat 1 Tube 16" (Adj. Min 20³/₄" Max 28 7/16")</p>  <p>Cat 1 — — Cat 1</p>
	<p>1689 Top Link 20" Cat 2 Tube 20" (Adj. Min 25 3/32" Max 36 7/32")</p>  <p>Cat 2 — — Cat 2</p>
	<p>3028 Top Link Ford 4000 4600 16.75" Cat 1 + 2 Adj Min 24 1/2" Max 31 1/4"</p>  <p>Cat 1 — — Cat 2</p>
	<p>3027 Top Link Ford 5600 7600 17" Cat 2 Adj Min 24 1/2" Max 31 1/4" - 622 - 794mm</p>  <p>Cat 2 — — Cat 2</p>
	<p>41309 Top Link Ford 40 - CAT 2 Ball 28mm Eye Fiat M100 to M160 - Knuckle 53469</p>  <p>Cat 2 — — Cat 2</p>
 <p style="text-align: right;"> CBM S.p.A. CORTESEGGIO MECCANICHE</p>	<p>42066 Top Link Assembly TM TS Cat 3 Hook</p>  <p>Cat 3 — —</p>
	<p>21007 Quick Hitch Hook CAT 2 & Knuckle End Top Link Tube 15" (Adj. Min 20 11/16" Max 32 1/16")</p>  <p>Cat 2 — —</p>
 <p style="text-align: right;"> CBM S.p.A. CORTESEGGIO MECCANICHE</p>	<p>52461 Top Link T6010 T6020 T6030 T6040 T6050</p>  <p>Cat 2 — — Cat 2</p>

Linkage Parts

43153

Top Link Pin Ford 8530 8630 8730 8830
TW15 TW25 TW35 TW5 Cat 3
OE Ref: 83947067

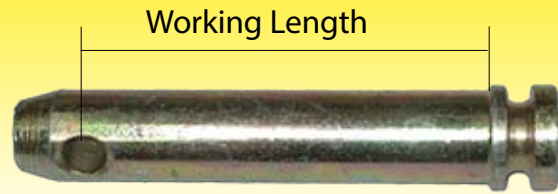

195589

Top Link Pin Cat 1 Working Length: 102mm

195590

Top Link Pin Cat 1 Working Length: 110mm

1461

Top Link Pin Cat 1 4.75" Working Length: 127m

2363

Top Link Pin 188 CAT 2 4 5/16' Working 110mm

195591

Top Link Pin Cat 1 Working Length: 76mm

43294

Plunger Draft Control Ford 2610 2810 2910 3610 3910 4610 2600 3600 4600
2310 3230 3430 3930 4130 4630 4830 5030 231 233 234 333 334
OE Ref: 81801588



4965

2/3000 Dexta Super Dexta Top Link
Rocker



43295

Yoke Draft Control Ford 2610 - 2910
3610 3910 4610 2600
OE Ref: 81815672



43206

Pin Top Link Ford 40 Series TS Series
28mm Length 129mm Diameter 28mm
OE Ref: 82007676



53475

Bush Top Link Conversion Cat 2 Cat 3



Brakes, Hydraulics & Linkage

Linkage Parts



3811
12' Cranked Towing Ring 30mm Thick



6842
Trailer Hitch 12" Straight Shank H/D
40mm Th



3788
Trailer Hitch Straight Shank 12"
30mm Thick



62228
Ball Cat 2/2 For
Lower Quick
Release End



1723
Bush For Drawbar
Pin & Hitch

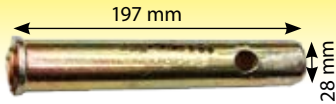

4725
Link Pin 7" Cat 2 Lower



180901
Hinged Articulated Pin 10 5/16'
Collar type for 20D - USE 62011



42141 Top Link Pin Cat 2 25 x 142mm
42139 Top Link Pin Cat 2 25 x 102mm
42140 Top Link Pin Cat 2 25 x 83mm



52881
Lower Link Pin Cat 2

Linkage Parts

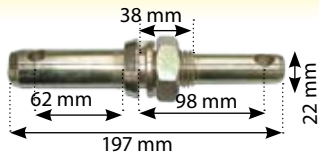

1967
Implement Pin 1 1/8" BSW

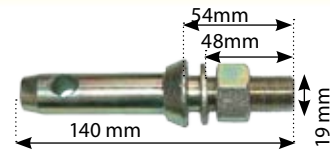

1245
Implement Pin Cat 1 - 3/4" UNF

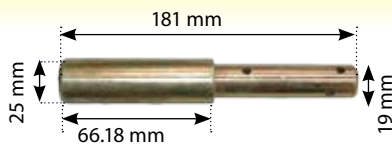

1997
Top Link Pin Cat 1 & 2 166mm Long

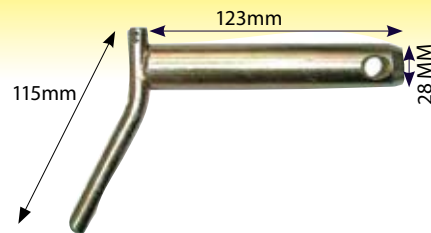

4045 Top Link Pin CAT 1 c/o Handle
4078 Top Link Pin CAT 2 c/o Handle
4724 Link Pin Cat 1 Lower

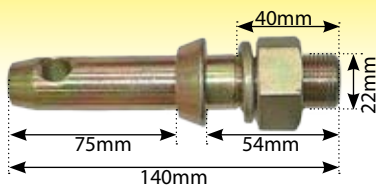

1387A
Implement Pin Cat 1 - 7/8 UNF

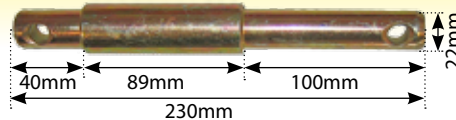

51115
Link Pin 230mm Lower CAT 1/2

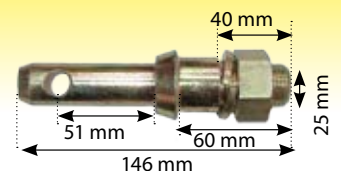

1246
Implement Pin Cat 1 - 7/8" UNF
7/8 Shoulder

1103
Implement Pin Cat 2 - 7/8" UNF
7/16 Shoulder

Brakes, Hydraulics & Linkage

Lift Arm Ends

Quick Release Ends



61226
Quick Attach Hook Kit 6200 8200 Cat 3
Also fits John Deere



59039
Repair Kit Lower Link John Deere Ford Fiat Case Cat 3



41936
Lift Arm Latch Cat 3 M/60 40/TM 30 Series

63236
Lever Quick Attach CAT3 With Pin



63237
Lever Spring Cat 2 Cat 3 Quick Attach



61227
Quick Attach Hook Kit 390 4200 6200 Cat 2
Also fits John Deere



59035
Repair Kit Lower Link John Deere Fiat Cat 2



41937
Lift Arm Latch Cat 2 7610 40 Series John Deere ** Kit 59035 **

59058
Lever Quick Attach CAT2



63237
Lever Spring Cat 2 Cat 3 Quick Attach



Weld On Ends



2407
Weld on End Cat 1 Lift Arm



2408
Weld on End Cat 2 Lift Arm

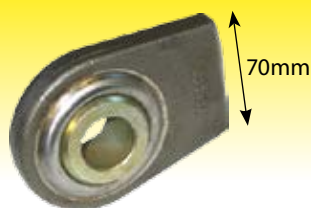

4088
Weld on End Cat 2 Heavy Duty Lift Arm

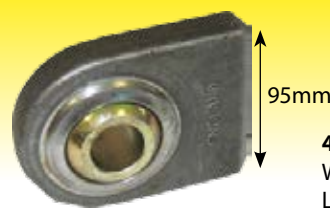

4086
Weld on End Cat 2 Heavy Duty Lift Arm



51095
Weld on End Cat 1 Top Link



51094
Weld on End Cat 2 Top Link

Linkage Parts

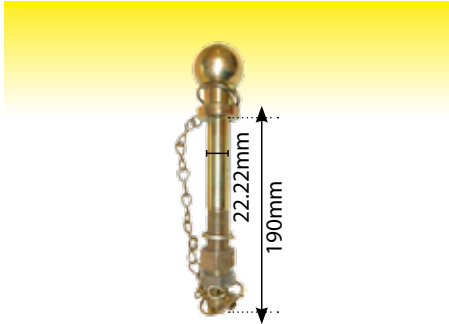

3642
Ball Hitch Pin & Chain 7 1/2" x 7/8"

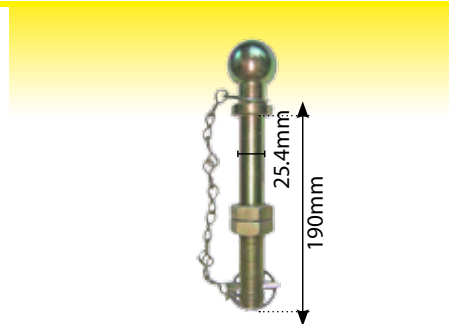

4672
Hitch Ball 7 1/2" x 1" Pin & Chain

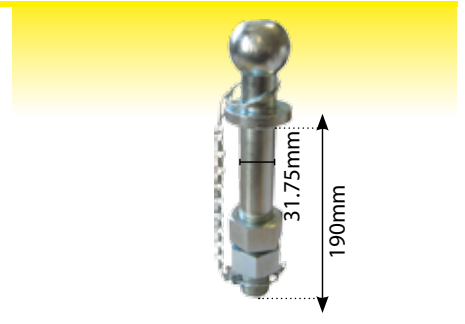

1403
Hitch Pin and Ball 1 1/4"



1386
Hitch Pin 7/8" Short Ball

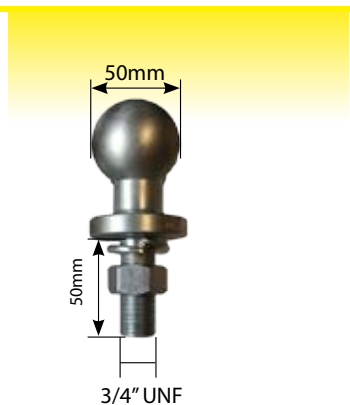

53484
Ball Hitch Pin Short 50mm 19 x 50mm 500kg

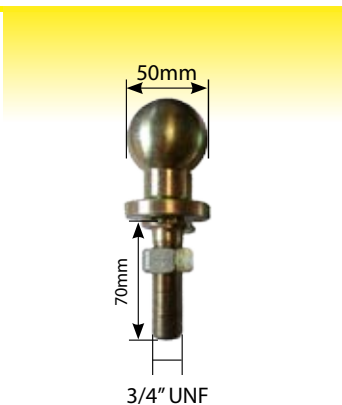

53479
Ball Hitch Pin Short 50mm 19 x 70mm 500kg

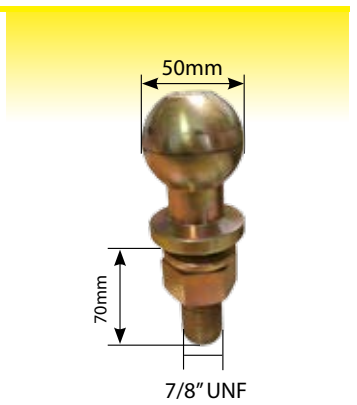

53480
Ball Hitch Pin Short 50mm 25 x 70mm MAX:500k



2705
Lower Link Pin Ford 5000 7600

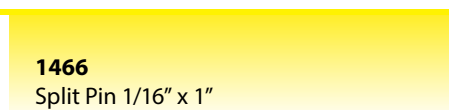

1466
Split Pin 1/16" x 1"



1187
Cotter Pin Ford 10s



52882
Hitch Pin 1 3/8" x 7 3/16" Zinc Gold Passivat

Linkage Parts



1236
Linch Pin 1/4" - 6mm



42101
Linch Pin Assembly



42102
Linch Pin Assembly c/w Chain TSA
TL TLA T6000

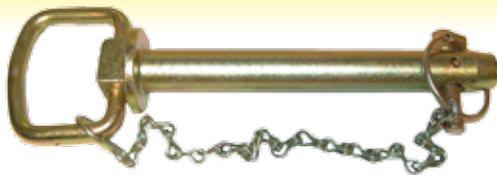

1006 Tow Pin Cat 1 7/8" Chain
1755 1" Tow Pin 6" Chain
1779 Tow Pin 6" 1 1/8" Thick
4163 1 1/4" Tow Pin Chain

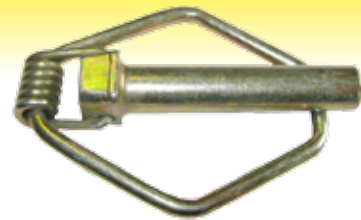

53027
Linch Pin Safety 10mm

R Clips

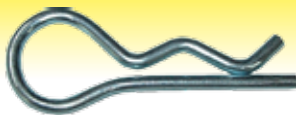

3122 2.00 mm R Clip
1668 3.00 mm R Clip
1666 4.00 mm R Clip
3607 5.00 mm R Clip
3608 6.00 mm R Clip
3363 7.00 mm R Clip



2480 3.00 mm Double R Clip Double R Clip
2481 3.50 mm Double R Clip Double R Clip
2482 4.00 mm Double R Clip Double R Clip
2483 4.50 mm Double R Clip Double R Clip
2484 4.50 mm Double R Clip Double R Clip
2485 6.00 mm Double R Clip Double R Clip
2479 6.00 mm Double R Clip Double R Clip
2486 7.00 mm Double R Clip Double R Clip

53057

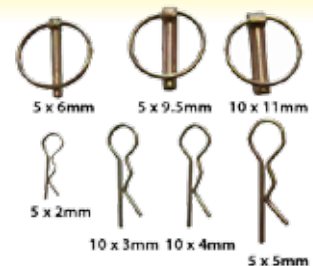

5 x 6mm 5 x 9.5mm 10 x 11mm
5 x 2mm 10 x 3mm 10 x 4mm 5 x 5mm

Linch Pin & Grip Clip Assortment Pack Qty 50

Quick Release Ends

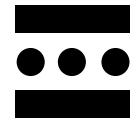

CBM S.p.A
COSTRUZIONI MECCANICHE

CAT 2

41734

Quick Release End CBM type
Weld On Cat 2

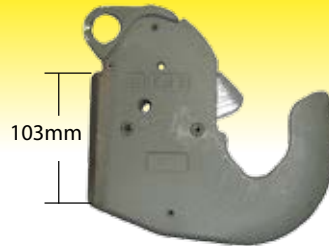

41735

Quick Attach Hook
Kit CBM Cat 2



CAT 2S

41773

Quick Release End CBM CAT 2S
Weld On LH+RH

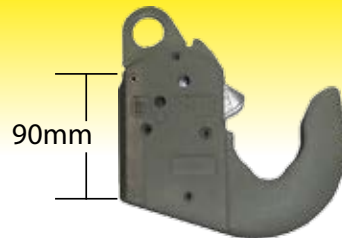

53839

Quick Attach Hook Kit Cat 2S
Cat 2s



CAT 3

53381

Quick Release End CBM Weld
On Cat 3

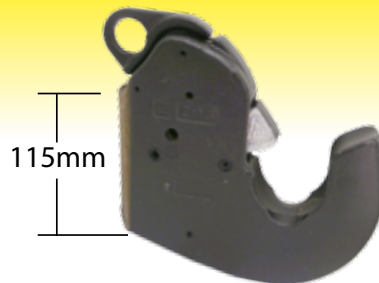

41736

Quick Attach Hook Kit CBM
Cat 3

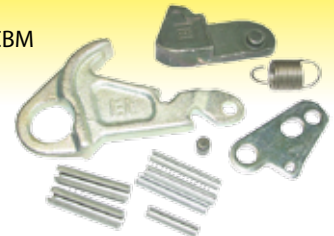

CAT 4

64444

Weld On Quick Attach Hook
OE Ref: 3905500M91



53836

Cat 4 Quick Attach
Hook Kit CBM



41739

Eye bolt Ring Quick Re-
lease Chain 3000 5400



41746

Chain For Quick
Release CBM Type



Brakes, Hydraulics & Linkage

Hitch Parts

Kit = 41792

1. **3008**
2. **409752**

Bolt M8 x 25 Coarse Zinc & Yellow
Hitch Pin End Cap Ford 40 M TD TL TM TS

Kit = 41792
Latching Hook Kit Ford 40 60 M TM TS ** Includes End Caps and Screws **

43052
Seal Hydraulic Cross Shaft
Ford TM140 Fiat
115/90

43053
Seal Lift Arm Ford TM140 Fiat F110
120 130
140

404879
Pick Up Hitch Cable Ford 40
TL TS

42070
Pick Up Hitch Cable TSA T6

409637
Lift Cable Ford 81-8360
Mech. Controlled
Also fits TM115-140

42990
Pick Up Hitch Cable TM115 - TM165 11/99 - 06/02
Length 1420mm Sleeve 1240mm

42991
Pick Up Hitch Cable 8160 - 8560 TM115 - TM165
09/95 - 01/00 Length 1310mm Sleeve 1140mm

409688
Spring Ford 40 60 TM TS TSA for PUH Latch

409769
Ford 40's Pick Up Pull Bar Locating Pin

409834
Latching Hook Key Ford 40 60
M TM TS 32.5 mm

409835
Latching Hook Key Ford 40
60 M TM TS - 36mm

409830
Latching Hook Shaft Ford 40 60 M TM TS (36.5mm Key)

409765
Hinge Pin Ford 40 M TM TS Pick Up Hitch

Hitch Parts

Pick UP Hitch Latch Kit - 3 Hook

43638

NEW HOLLAND T7 TM T6000 T7000 SERIES

STEYR CVT 6130-6230, PROFI 4000 SERIES

Description	Qty
1 Latch Right Hand	1
2 Latch Left Hand	1
3 Latch Centre	1
4 Spring Left Hand	1
5 Spring Right Hand	1
6 Key Way Left Hand/Right Hand	2
7 Keyway Centre	1
8 Shaft	1
9 Spacer	2
10 Bolt/Wash/Nut	4

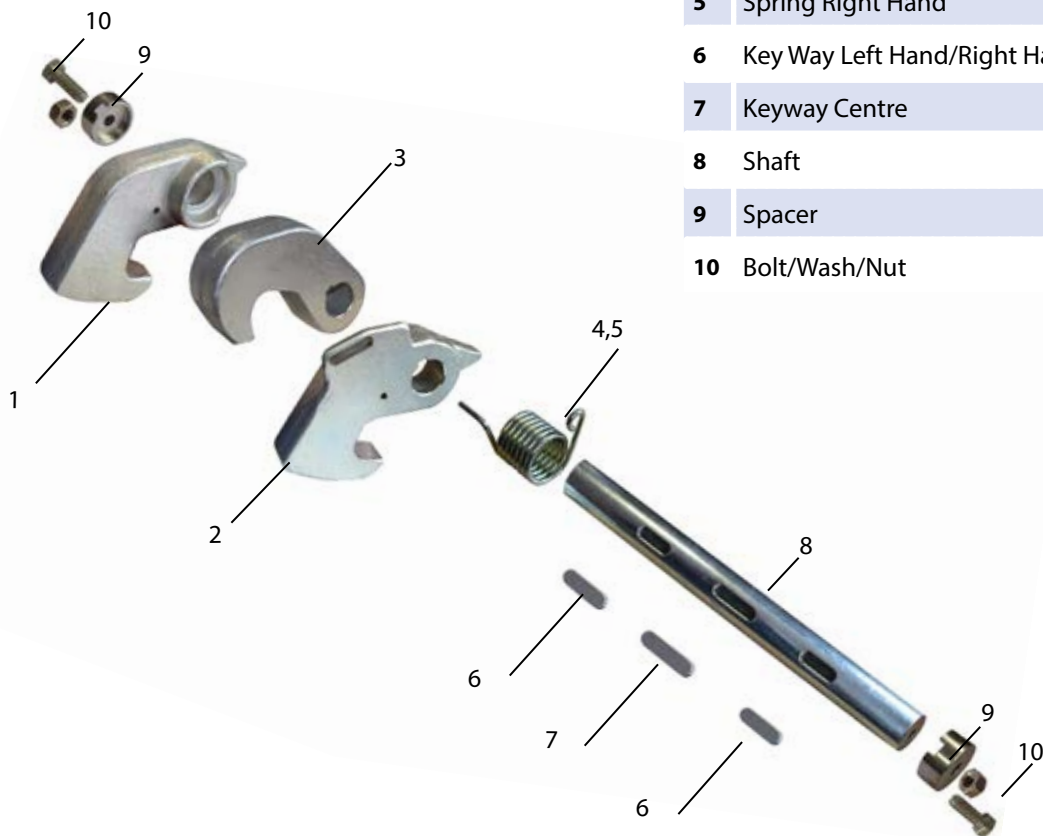

Hitch Parts



41892
Pin Lift Rod Ford
5640-8340 TS TM
M TL T7000
**Suits our Lift
Rod**

409908
Lift Rod Assembly
Ford 40's - PAIR
Heavy Duty
Slide Pipe is 50.5 cm
long*



41892
Pin Lift Rod Ford
5640-8340 TS
TM M TL T7000



41166
Lift Rod Assembly Ford
60's TM (Pairs Only)
Heavy Duty Slide
Pipe is 56cm long **



41893
Pin Lift Rod Ford 5640-
8340 TS
**Suits Slotted Lift
Rod**



409770
Pick Up Hitch Nut
Ford 40's



409795
Pick Up Hitch Pin Ford
5640-8340/TS 65mm From
4/94



409797
Pick Up Hitch Pin Ford
5640-8340 73mm
(To 3/94)



42451
Pivot Pin Pick Up
Hitch TS110



409751
Hitch Stud Ford 40's/M/TM/
TS SL Hitch Only 100.6 mm
long



409771
Pick Up Hitch Bolt Ford 40's
87.4mm long



42453
Grommet Automatic Hitch TM115

Ford Pick Up Hitch Components



4062
Drawbar Pin Clip Ford



3296
Hitch Pin Ford 5000 - 7600 28.5 x 109 mm



2190
Pick Up Hitch Lev Clip 7810 8210 (Pk 5)



4523 Auto Hitch Lift Rod Adjuster
4524 Auto Hitch Lift Rod Lock Nut

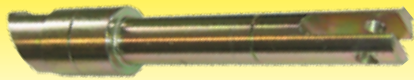

2297
Pick Up Hitch Tongue Ford



3931
Pick Up Hitch Cable Ford 6610 - 8210



4364
Pick Up Hitch Lift Rod End Ford

42062
Lift Rod Guide Ford
5610 - 8210
** 42065 is Lift Rod **



42065
Lift Rod Ford 5610 - 8210
Suits 42062 Lift Rod Guide

Short



3756
Hitch Lift Rod
Ford 4000 4600
Adj Min 460mm
Max 830mm **
Long Tube Version
is 1702 ** 1875 is
Rod *

Long



1702
Pick Up Hitch Lift Rod
Ford 4000 5000 4600
6600 7600 ** FOR 11
X 32 WHEELS ONLY **
** Short tube version
is 3756 ** 500mm
Long



1875
Pick Up Hitch Lift Rod Ford
4000 5000 (442mm)
Suits 3756 & 1702



4326
Pick Up Hitch Latching Hook Ford 5110
5610 6410 6610 6810 7610 - 8210 **
4013 is Hook **



4013
Pick Up Hitch Lock Hook Ford
5610 8210 ** 4326 is Hook with
Bar **



scharmüller
ANHÄNGERKUPPLUNGEN



K80 RANGE

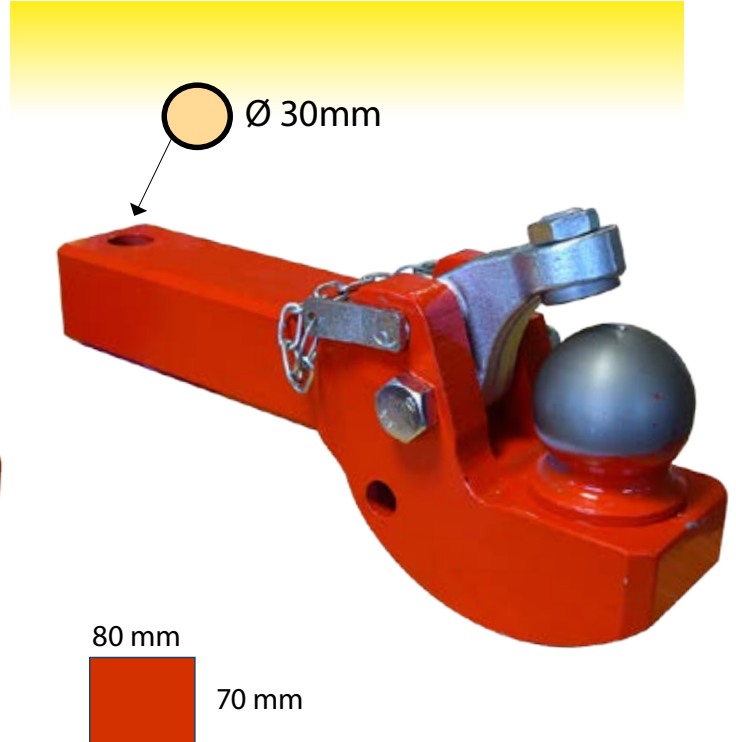
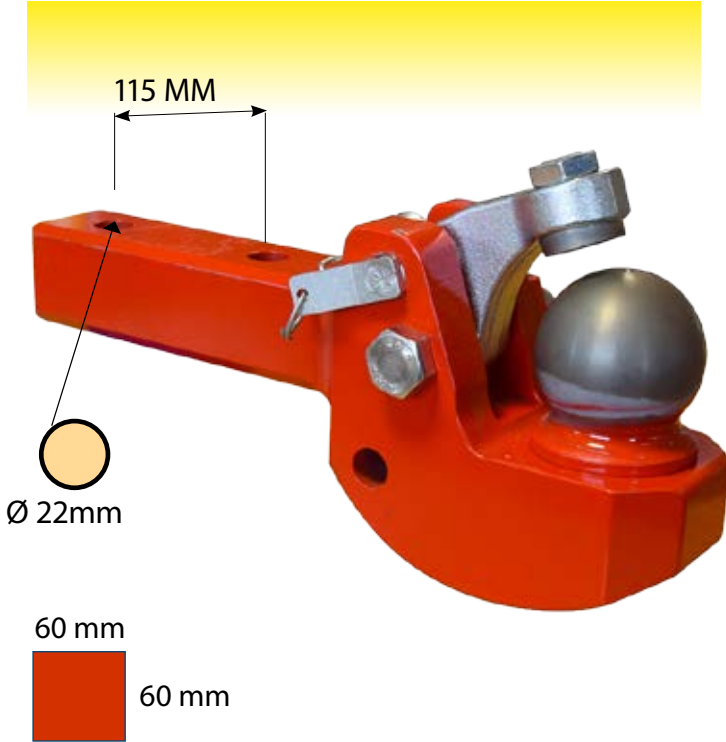

58883 OE Ref: 00.421.10.2-A20

Claas: Ares 500/600 Arion 500/600
Fendt: Vario 200/300
John Deere: 7010, 8000
Massey Ferguson: 5600 6445-6480 7600

58884 OE Ref: 00.429.00.2-A20

Claas: Axion 800/900
Fendt: Vario 700/800/900
John Deere: 8030/8R
Massey Ferguson: 6485-6499, 6485-6499, 7624, 7626, 8200: 8210, 8280; 8400
McCormick: MTX: 165, 175, 185;
Valtra: S-Series

INTERCHANGEABLE WITH

INTERCHANGEABLE WITH

DRSP30033
oe ref: L156433



DRP47902
oe ref: L156433



58837 Oe Ref: 00.651.90.0-A01

K80 Weld On Spoon Universal

ALWAYS TRANSMISSION OF HIGHER VERTICAL LOADS
PLAY - FREE CONNECTION, ELIMINATES RATTLE
GREATER ANGULAR MANEUVERABILITY
QUIETER TOWING
NO UPWARD MOVEMENT FOR TIPPING TRAILERS - RESULTS IN LESS WEAR



58886 Oe Ref: 00.428.00.5-A20
John Deere: 6010, 6020, 6130, 6R, 7020, 7030, 8010, 8020, 8030

INTERCHANGEABLE WITH

DRP00515
 oe ref: L156433, AL159328

DRP82406
 oe ref: AL159328, L156433



53829 Oe Ref: 00.652.90.0-A02



K80 Towing Spoon 110 x 100mm

53828
 K80 Weld On Plate
 110 x 100mm



53853
 Bolt Kit M16 x 60mm
 10.9 Strength



53827 Ref: 00.650.90.1-A02



K80 Towing Spoon 145 x 145mm

53830
 K80 Weld On Plate
 145 x 145mm
 OE REF: 00.645.00.0



53854
 Bolt Kit M20 x 80mm
 10.9 Strength



Brakes, Hydraulics & Linkage

Lower Links

4418 Cat 2



Link Ball Lower c/o Guide Cone Cat 2 ***Pin To Suit 4419***

4419



Linch Pin for 4418
12mm Diameter Pin

4727

Cat 3/3



Link Ball Cat 3/3 & Guide Cone
Pin To Suit 4419

4729

Cat 2/3



Link Ball Cat 2/3 & Guide Cone
Pin To Suit 4419

Lower Link Balls

53041 Cat 1/2



Lower Link Ball Dual
Cat 1/2

2539 Cat 3/2



Lower Link Ball
Cat 3/2 ID 29 OD 63.5

2540 Cat 3/3



Lower Link Ball Cat 3/3
ID 37.5mm OD 63.5mm

62228 Cat 2/2



Ball Cat 2/2 For Lower
Quick Release End

886428 Cat 1



Lower Link Ball Cat 1
Interchangeable
Fits 100 200 300 4200 4300
600 Series

886429 Cat 2



Lower Link Ball Cat 2
Interchangeable
Fits 100 200 300 4200 4300
500 600 Series

1252 Cat 2



Linkage Ball Ford Fiat Cat 2
ID 28mm OD 57mm Width
45mm
[OE REF: C5NN557A 81801634](#)

1869219



Lift Arm Ball Clip

Lower Link Conversion Bushes

43155 Cat 2 to Cat 3



Bush Lower Link Conversion
Cat 2 to Cat 3

53496 Cat 2 to Cat 3



Bush Lower Link Conversion Cat 2 to Cat 3
ID 1 1/8" OD 1 7/16" Length 2 1/2" 63.5mm

2424 Cat 1 to Cat 2



Lower Link Conversion Bush 1 1/8' to 7/8'

Top Links

21018

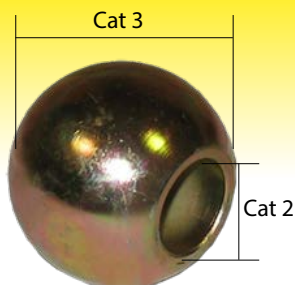

Cat 2/3

- Top Link Ball Cat 2/3
- I/D Ø: 1".
 - O/D Ø: 2 23/64".
 - WIDTH: 2".

21019



Cat 3/3

- Top Link Ball Cat 3/3
- I/D Ø: 1 9/32".
 - O/D Ø: 2 23/64".
 - WIDTH: 2".

4044

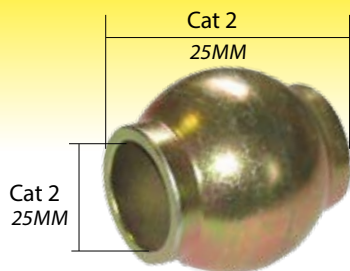

Cat 2/2

Top Link Ball CAT 2

21001



Cat 3

Ball Cat 3 Toplink

Top Link Conversion Bushes

53475



Bush Top Link Conversion Cat 2 Cat 3

42144



Top Link Conversion Bush Ford 10 100 Cat 1/2
1000 30 40 Industrial TW Series

Linkage CBM Type

59289



Pin Plate Square John
Deere 6000
20mm Hole

59288

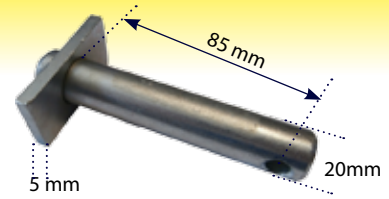

Lower Levelling Box
Pin John Deere 6000

41747

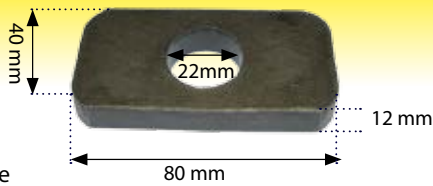

Bottom Fork Plate
CBM Type 22mm



41748

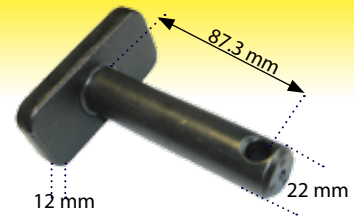

Bottom Fork Lift Link Pin
CBM Type 22mm



59822

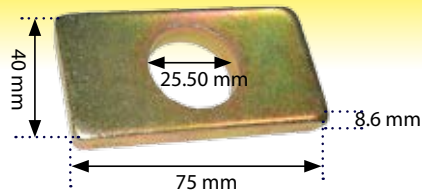

Fork Plate John
Deere 76 77 7810
Bottom

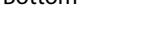

41743

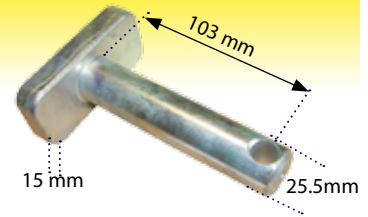

Bottom Fork Lift Link Pin
CBM Type 25.50mm



41740

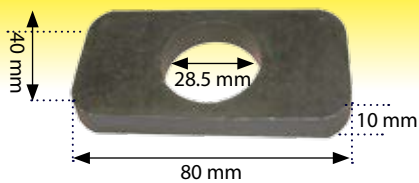

Bottom Fork Plate CBM
Type 28.5mm hole



41741

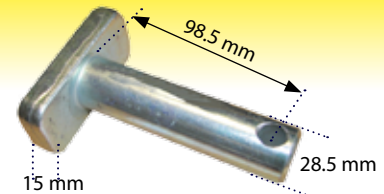

Bottom Fork Lift Link Pin
CBM Type 28.5mm



41744

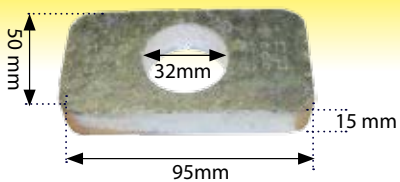

Bottom Fork
Plate CBM Type
32mm hole



41745

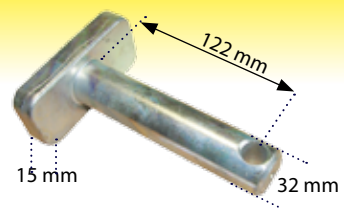

Bottom Fork Lift Link
Pin CBM Type 32mm



Dromone Hitch Components

DRSP80155
Hitch Bag Ford 10's



DRP48860
Drop in Pin to suits Tow Hook -
80mm Length



DRSP30033
Pick Up Hitch Hook ISO
60mm 115mm btw Holes

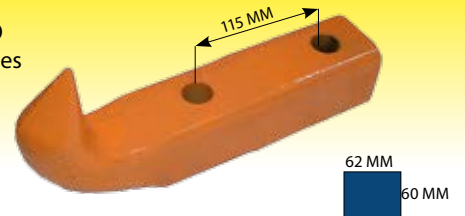

DRSP30293
Drawbar Assembly ISO
** 55mm Centres **

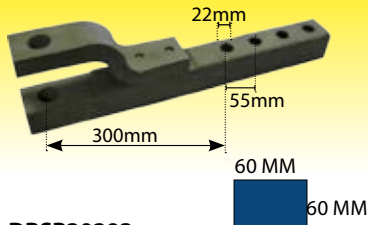

DRSP30293G
Drawbar Assembly ISO 57.5mm
centre to centre

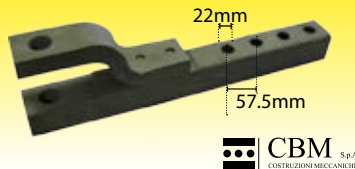

DRSP30291
Drawbar Reversible ISO

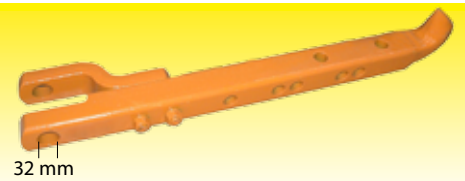

61215
Pick Up Hitch Hook Heavy Duty

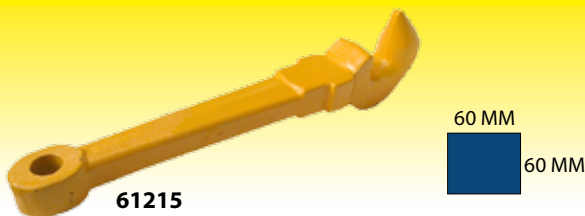

DRP47901
Pick Up Hitch Hook Dromone Head -
60mm



DRP49224
Top Arm Pin

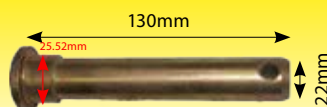

DRSP6042
Top Arm Pin Ford TM/60 's



DRP79028
Lift Rod Ford 5000-8210/40's



Brakes, Hydraulics & Linkage

Dromone Hitch Components



DRP57050
Rubber Buffer

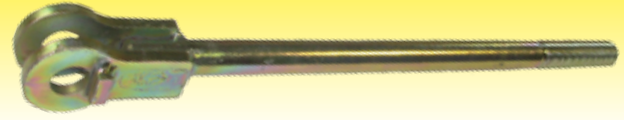

DRSP6055
Lift Rod Ford TM 60



DRSP30312
Ram Hydraulic Release Dromone Hitch (Overall length 9 1/4" 23.5cm)



DRP59000
Pick Up Hitch Cable - 1820mm Pull Cable Standard Pull Sleeve 1500mm Overall 1900mm



DRP44340
Nut Lift Rod 20 mm

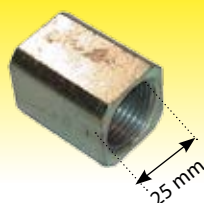

DRP44341
Nut Lift Rod 25mm

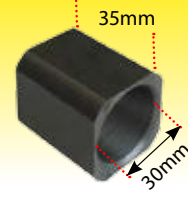

DRP43206
Nut spacer Lift Rod 30mm (No Thread)

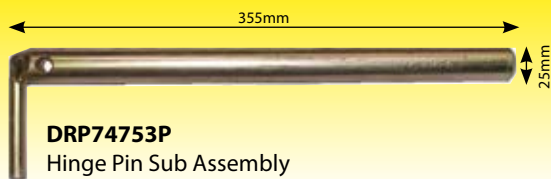

DRP74753P
Hinge Pin Sub Assembly

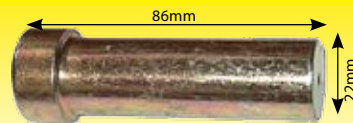

DRP48818
Drop In Pin - 2 Pin Type Push Back

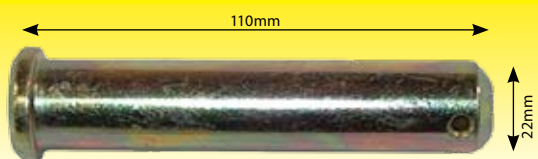

DRP48832
Drop In Pin

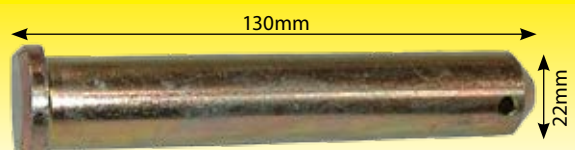

DRP48810
Drop In Pin