

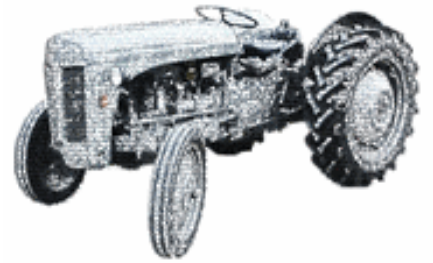

# L.O.G Heigl









Replacement Parts Suitable for **CASE TRACTORS**



## Parts Catalogue

## Case IHC

Engine	3	
Gaskets	3	
Engine Components	4	
Exhausts	10	
Fuel Parts	16	
Cooling	18	
Radiators	24	
<b>Filters</b>	<b>28</b>	
<b>Axle Parts</b>	<b>40</b>	
Wheel Hubs	40	
High Spindles	41	
Track Rod Ends	46	
Front Axle Parts	47	
<b>Cab, Sheet Metal &amp; Electrical</b>	<b>50</b>	
Cab & Sheet Metal	51	
Side Panels	53	
Seats	55	
Glass	62	
Wiper Motors	66	
Starters	70	
Lamps	78	
<b>Clutch, Transmission &amp; PTO</b>	<b>84</b>	
<b>Brakes, Hydraulics &amp; Linkage</b>	<b>96</b>	
Brake Parts	96	
Hydraulic Pumps	100	
Linkage Parts	102	
Stabilisers	104	
Dromone	110	

## Gaskets

**3090**

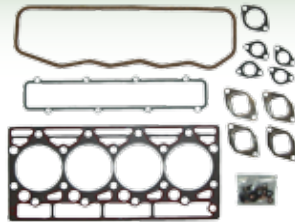

Head Gasket Set IHC 684 784

**3091**



Sump Gasket Set  
IHC 684 784

**3092**



Head Gasket IHC 624 - 844

**2338**



Rocker Cover Gasket IHC 745 844

**52140**

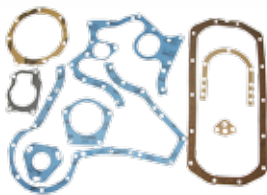

Sump Gasket Set IHC 414 444  
Also Fits 434 374 384 & Case

**52139**

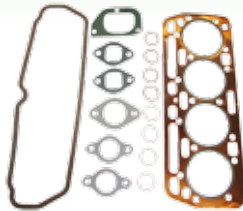

Head Gasket Set IHC 414 444  
Also Fits 434 374 384 & Case

**53432**

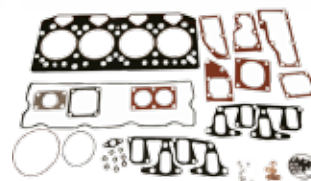

Head Gasket Set Case CX100  
CX70 CX80 CX90MX100C  
MX80 MX90X Ghibli 90 100  
Mythos 90 100



**3681E037**  
Head Gasket Phaser 4  
Cylinder Turbo/Non CX Series  
CX100, CX70, CX80, CX90  
MX Series MX100 C, MX80  
C, MX90 C Turbo [OE Ref: 291958A1 311766A1](#)

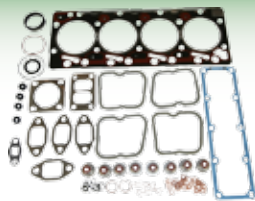

**Q3804896**  
Head Gasket Set Cummins 4B Engine  
Case IH 5120 5220



**Q3802375**  
Sump Gasket Set Cummins 4B Engine  
Case IH 5120 5220



**Q3938162**  
Sump Gasket Cummins 4B Engine  
Case IH 5120 5220



**Q3804897**  
Head Gasket Set Cummins 6B Engine  
Case IH 5130 5140 5150 5230 5240 5250  
MX100 MX110 MX120 MX135 MX150  
MX170







**Q3802376**  
Sump Gasket Set Cummins 6B Engine  
Case IH 5130 5140 5150 5230 5240 5250



**Q3959052**  
Sump Gasket Cummins 6B Engine Case  
IH 5130 5140 5150 5230 5240 5250





## Engine Components

<p><b>1436</b></p>  <p>Engine Kit IHC 884 885 D268 - 100mm Piston &amp; Ring &amp; Liner</p>	<p><b>1430</b></p>  <p>Piston &amp; Liner IHC 784 785 844 D246 - 100mm</p>	<p><b>2108</b></p>  <p>Ring Gear IHC 484 584 674 784 - 126 Teeth 3210 3220 3230 4210 4220 385 485 585 685 785 885 278 454 474 574</p>	<p><b>51001</b></p>  <p>Ring Gear IHC 885 956 42'S 128 Teeth 288 4230 4240 884 885 885XL 895 895XL</p>	<p><b>52311</b></p>  <p>Ring Gear Case 844 845 856 955 956 1055 1056 1255 OE Ref: 3144607R1</p>
---	---	--	--	--

Model	Piston	Ring	Liner	Seal
275/276/354 B250	 <b>52136</b>	 <b>52137</b>		
414 444 434 384 374	C/O Rings <b>52739</b>		<b>52166</b>	<b>52179</b>



**52440**  
Engine Kit Case MX100 MX110 MX120 MX135 MX150 MX170  
OE Ref: J802747

<p><b>4771</b></p>  <p>Crankshaft Oil Seal IHC 684 Zetor 9540 Rear 110 x 130 x 12.7mm</p>	<p><b>3967</b></p>  <p>O Ring IHC For Liner</p>	<p><b>52141</b></p>  <p>Crankshaft Seal IHC 414 444 Front Also Fits 434 374 384 &amp; Case - 73 X 48 X 12</p>	<p><b>52142</b></p>  <p>Crankshaft Seal IHC 414 444 Rear Also Fits 434 374 384 &amp; Case - 3.63"x4.38"x0.7</p>
--	--	---	---

<p><b>1253</b></p>  <p>Timing Cover Seal Kit IHC</p>	<p><b>1253S</b></p>  <p>Timing Cover Seal IHC (Only) Front 77mm x 100mm</p>	<p><b>4772</b></p>  <p>Gasket Rear Crankshaft 684</p>
---	--	--

## Engine Components

**52609**

Cylinder Head IHC 414



**52608**

Combustion Cap  
IH 414



**52284**

Crankshaft Case IH 74 Series  
84 Series 3484 276 354 434  
444 B250 B275 B414  
OE Ref:3110995R91



**52180**

Crankshaft IHC 554 584  
624 654 595XL 733 740 c/o  
Balancer Gear Ring



**Q3901306**

Cam Bush Cummins 4B 6B  
Engine \*\* 1 Per EngineCase  
IH 5130 5140 5150 5230 5240  
5250MX100 MX110 MX120  
MX135 MX150 MX1705120  
5220



**Q4891178**

Gudgeon Pin Bush Cummins  
4B 6B Series EngineGudgeon  
Pin Bush Cummins 4B 6B Series  
Engine Case IH 5130 5140 5150  
5230 5240 5250 MX100 MX110  
MX120 MX135 MX150 MX170  
5120 5220



**Q3900709**

Crank Seal Front Cummins 4B  
6B EngineCase IH 5130 5140  
5150 5230 5240 5250MX100  
MX110 MX120 MX135 MX150  
MX1705120 5220



**Q3933262**

Rear Seal Cummins 4B 6B  
EngineCase IH 5130 5140 5150  
5230 5240 5250MX100 MX110  
MX120 MX135 MX150 MX170  
5120 5220

### Cummins B Rod Bearings

<b>Q3939859</b>	Standard
<b>Q4932375</b>	.25 mm
<b>Q4932376</b>	.50 mm



### Cummins 4B Main Bearing Set

<b>Q3802010</b>	Standard
<b>Q3802011</b>	.25 mm
<b>Q3802012</b>	.50 mm



### Cummins 6B Main Bearing Set

<b>Q3802070</b>	Standard
<b>Q3802071</b>	.25 mm
<b>Q3802072</b>	.50 mm



### Main Bearings

Model	Standard	10 Thou	20Thou	30Thou
554	<b>52187</b>	<b>52188</b>	<b>52189</b>	<b>52190</b>

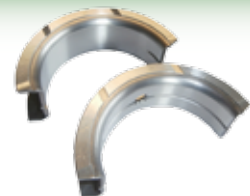

**52450**

Main End Bearing Set  
Case 276 354 374 384  
434 444 B250 B275 B414  
OE Ref: 708912R91



**52410**

Big End Bearings IHC 574 585 595 PAIR  
684 685 744 785 844 845 885 895  
OE Ref: 3055351R91



**52313**

Main Bearing Case IH 955  
1056 745 595  
\*\*Will Not Fit 51's\*\*  
OE Ref: 3055130R21



## Engine Components

### 52417

Oil Pump Case 743XL  
844XL 745XL 845XL 1056  
1056XL 856XL 956 956XL  
Transmission  
OE Ref: 89334C3



### Q3937404

Oil Pump Cummins B Series  
Case IH 5130 5140 5150  
5230 5240 5250 MX100  
MX110 MX120 MX135 MX150  
MX170  
OE Ref: 3937404



### 2135

Engine Oil Pump IHC 4  
Cylinder 4120 4230 4240 574  
584 585 595 674 684 685 695  
784 884 885 895  
OE Ref: 3136430R95



### 41314078

Oil Pump Case CX50, CX60  
OE Ref: 736513M91



### 4132F041

Oil Pump New Mid Mounted Balancer Case  
CX100, CX70, CX80, CX90, MX100 C, MX80 C,  
MX90 C  
OE Ref: 3637489M91



### Q3957543

Oil Cooler Cummins B Series 4B  
Only  
OE Ref: 3957543



### 42883

Oil Pump JX 55, JX60, JX65, jX75, JX80,  
JX85 OE Ref: 4705827



### 42941

Oil Pump Case MXM120, MXM130,  
MXM135, MXM140, MXM150  
OE Ref: 81868538



### Q4897480

Oil Pump Case NEF, Maxxum 100,110,  
4 Cylinder Only OE Ref: 4897480



### Q4897481

Oil Pump Case NEF, Maxxum 115,125,  
140,6 Cylinder Only OE Ref: 4897481



## Engine Components



**Q3802060**  
Piston Standard Non Turbo  
Cummins B Series Case IH  
5130 5230 Engine 6-590

**Q3802062**  
Piston 0.50mm Non  
Turbo Cummins B  
Series Case IH 5130  
5230 Engine 6-590

**Q3802100**  
Piston Standard Turbo  
Cummins B Series  
Case IH 5140 5150 5120  
6590

**Q3802102**  
Piston 0.50mm Turbo Cummins  
B Series Case IH 5140 5150 5120  
6590

Oil Holes

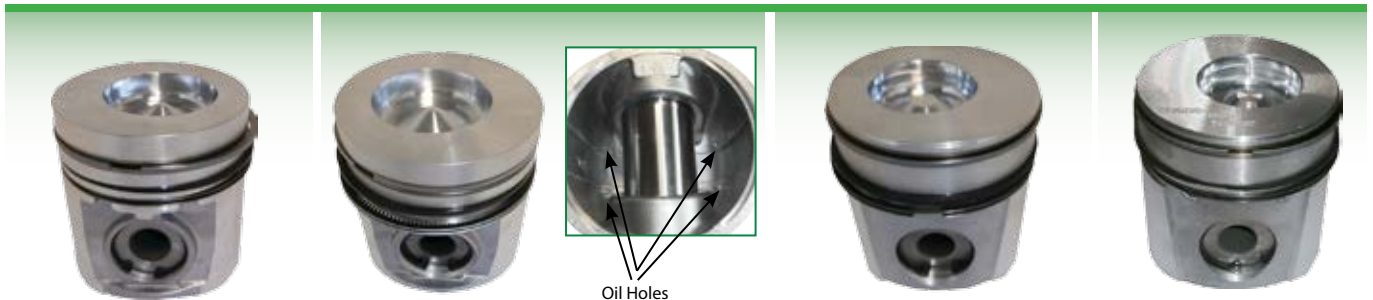

**Q3802160**  
Piston Standard Turbo  
Cummins B Series  
Case IH 5120 5140 5150  
5220 5240 5250

**Q3802132**  
Piston 0.50mm Turbo  
Cummins B Series  
Case IH 5120 5140 5150  
5220 5240 5250

Oil Holes

**Q3802747**  
Piston Standard Turbo  
Cummins B Series Case  
IH MX100 MX110 MX120  
MX135 MX150MX170

**Q3802764**  
Piston 0.50mm Turbo  
Cummins B Series Case  
IH MX100 MX110 MX120  
MX135 MX150MX170

## Engine Components



**Q3802040**

Ring Set Standard Non Turbo Cummins B Series Case IH 5130 5230 Engine 6-590



**Q3802042**

Ring Set 0.50mm Non Turbo Cummins B Series Case IH 5130 5230 Engine 6-590



**Q3802421**

Ring Set Standard Turbo Cummins B Series Case IH 5120 5140 5150 5220 5240 5250 MX100 MX110 MX120 MX135 MX150 MX170



**Q3802422**

Ring Set 0.50mm Turbo Cummins B Series Case IH 5120 5140 5150 5220 5240 5250 MX100 MX110 MX120 MX135 MX150 MX170



**Q3904166** Block Cylinder

Repair Sleeve Cummins B Series Case IH 5120 5130 5140 5150 5220 5230 5240 5250 MX100 MX110 MX120 MX135 MX150 MX170



**Q3802356**

Valve Exhaust Cummins B Engine Case IH 5120 5130 5140 5150 5220 5230 5240 5250 MX100 MX110 MX120 MX135 MX150 MX170



**Q3802355** Valve Intake

Cummins B Engine Case IH 5120 5130 5140 5150 5220 5230 5240 5250 MX100 MX110 MX120 MX135 MX150 MX170



**Q3900276**

Valve Spring Exhaust & Intake Cummins B Engine Case IH 5120 5130 5140 5150 5220 5230 5240 5250 MX100 MX110 MX120 MX135 MX150 MX170



**Date:**..... **No. of Pages:**.....

**Name of the Rep:**..... **A/C Number:**.....

**From:**..... **e-mail:**.....

**Phone No.:**..... **Fax No.:**.....

Please quote for the following parts - Quotation Number :

I wish to confirm the following order on Quotation Number:

Please supply the following parts:

Qty	Part No.	Description	Unit Price
1.			
2.			
3.			
4.			
5.			
6.			
7.			
8.			
9.			
10.			
11.			
12.			
13.			
14.			
15.			
16.			
17.			
18.			
19.			
20.			
21.			
22.			
23.			
24.			

Please photocopy this page

Please do not remove this page

**Comments:**  
 \_\_\_\_\_  
 \_\_\_\_\_

**Customer Signature:** \_\_\_\_\_ **Rep's Signature:** \_\_\_\_\_

## Exhausts

### 51011

Exhaust IHC  
414 444 48mm  
Inlet B275 276  
354 374 384  
2276 3434



### 3108

Exhaust IHC  
574 Black 454  
474 475 574  
674



### 52769

Exhaust Case  
CX90 c/o Stack  
Pipe Corner  
Post System

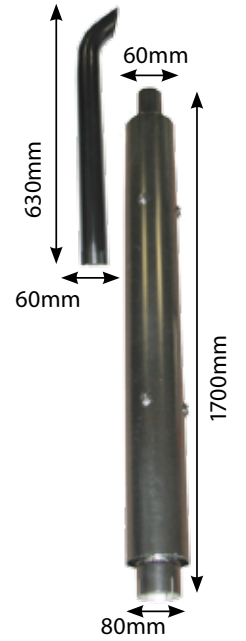

### 3110

Exhaust IHC 584  
- 784 Enamel 395  
484 485 495 584  
585 595 684 685  
695 784 785 795  
884 885 895



### 52055

Exhaust IHC 644 744  
844 845 440 540 640  
644 740 743XL 744  
840 844 844S 844XL  
845XL 940 4210 4220  
4230



### 52206

Exhaust IHC 46  
946 1046 55 955  
56 856 956 1056  
6 Cylinder



## Exhausts

**52655**

Exhaust Case MXM 120  
- 155 Corner Post

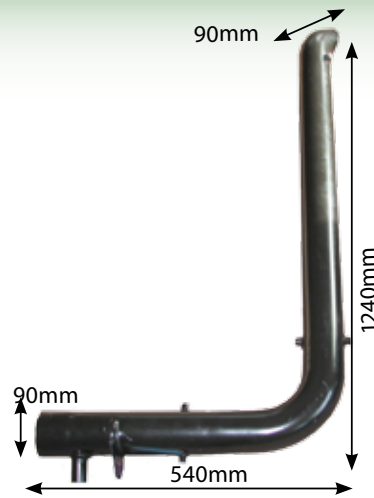

**53345**

Exhaust Case IH  
5120 5130 5140 5220  
5230 5240 5250



**42083**

Exhaust Box Ford TSA MXU Clip Type T6030 T6050 T6070  
TS115A TS125A TS130A TS135A



**42086**

Exhaust Case Maxxum 100,110, 120, 125,130  
Flat Flange [OE Ref: 87305649](#)



**52099**



Exhaust Case Maxxum 5140 5150 5130 5230 5240 5250

**53344**



Exhaust Box Case IH 5120 5220

**43639**

Exhaust Silencer Case JX60 - 80  
[OE Ref: 5093950](#)



**43640**

Exhaust Silencer Case JX70 JX90  
[OE Ref: 5094825](#)



## Exhaust Manifolds

### 52718

Exhaust Manifold IHC 885  
Elbow to suit is 52723  
Gasket=1129



### 52723

Exhaust Elbow IHC  
885 Suits 52718 \*\*  
Extensions Pipes  
52478 52321



### 1129

Exhaust Manifold Gasket IHC  
OE Ref: 3132434R1



### 52214

Exhaust Elbow  
Gasket IH Case  
885



### 52478

Silencer Pipe Screw On Case 238 268 288  
475 585 585XL 595 595XL 674 684 685  
685XL 695 695XL 784 785 785XL 795 884  
885 885XL 895 OE Ref: 80547C1



### 52321

Exhaust Elbow Extension Case  
585XL 595XL 685XL 695XL  
785XL 885XL 895XL \*\* 180 x  
60 mm \*\* Suits 52723 \*\*  
OE Ref: 80548C1



### 52241

Exhaust Manifold Case  
IH 544 553 654 664  
724 744 824 844



### 52711

Exhaust Manifold IHC 784



### 52242

Exhaust Manifold Gasket Case IH  
544 553 654 664 724 744 824 844



### 43620

Exhaust Manifold Case MXMs OE Ref: 87802374

Stud - 41868

### 409734

Exhaust Manifold Gasket New Type 3 & 6 Cylinder  
\*\*Steel Gasket\*\*  
OE Ref: 87801658



### 409734R

Gasket Exhaust Manifold \*\*Made of Thick Gasket  
paper\*\* OE Ref: 87801658



## Exhaust Elbows

**52233**

Exhaust Elbow Case IH  
553 654 724 824



**52234**

Exhaust Elbow Case  
IH 644 744 844



**52235**

Exhaust Elbow Case  
IH 743 745 844 845



**53451**

Gasket For 52235



**52236**

Exhaust Elbow Case IH  
955 1055 956 1056



**52238**

Exhaust Elbow Case IH 433 533 633 733  
833 933 440 540 640 780 840 940



**52237**

Exhaust Elbow Gasket Case IH  
955 1055 956 1056



**Date:**..... **No. of Pages:**.....  
**Name of the Rep:**..... **A/C Number:**.....  
**From:**..... **e-mail:**.....  
**Phone No.:**..... **Fax No.:**.....

Please quote for the following parts - Quotation Number :   
 I wish to confirm the following order on Quotation Number:   
 Please supply the following parts:

	Qty	Part No.	Description	Unit Price
1.				
2.				
3.				
4.				
5.				
6.				
7.				
8.				
9.				
10.				
11.				
12.				
13.				
14.				
15.				
16.				
17.				
18.				
19.				
20.				
21.				
22.				
23.				
24.				

Please photocopy this page

Please do not remove this page

**Comments:**  
 \_\_\_\_\_  
**Customer Signature:** \_\_\_\_\_ **Rep's Signature:** \_\_\_\_\_

### Fuel Tank Caps

**59840**



Fuel Tank Cap  
00/10/20's Lockable

**59436**



Fuel Tank Cap 00/10/20's  
No Lock

**2663**



Fuel Tank Cap IHC

**52697**

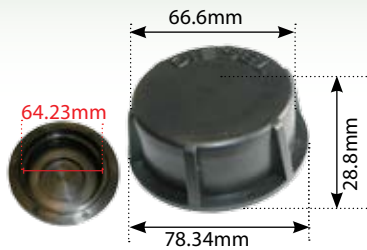

Fuel Tank Cap IH 42's  
Seal=52698

**52224**



Fuel Tank Cap Ford 35s T4000s TLs TNs Case JXs MXMs  
MXUs 84mm ID 89mm OD 22mm High

**52225**



Fuel Cap Case JX1060C JX1070C JX1070U  
JX1075C JX1080U JX1085C JX1095C JX55  
JX60 JX65 JX70 \*\* 100mm Diameter \*\*

**52227**



Fuel Cap Ford TL100 TL65 TL70  
TL80 TL90 TM135 TM150 TM165  
TM180 FITS BRAZILIAN MODELS  
ONLY

## Fuel Parts

**52019**



Fuel Sender Unit IHC 32s  
42s 3210 3220 3230 4210  
4220 4230 4240

**52015**



Fuel Sender IHC 784

**52182**



Fuel Sender Case IH 743XL  
745XL 744XL 856XL

**52181**



Fuel Sender Case IH  
485XL 495XL 585  
585XL 595

**42898**



Fuel Sender Unit JX55,  
JX60, JX65, JX70, JX75,  
JX80, JX85, JX90, JX95

**52474**



Fuel Sender Case 353 383  
420 435 423 533 553 554  
624 633 644 654 724 733  
743 744 844 844S 844XL  
OE Ref: 3057574R93

**52473**



Fuel Sender Case 1490  
1494 1594 1690 1694  
OE Ref: K309298

**52475**



Fuel Sender Case 553  
654 724 824 7455 745XL  
845 845XL 644 744 844  
844S 844XL 743 743XL  
OE Ref: 3058285R91

**52303**

Hose Fuel Tank Case 1055XL  
955XL 1056XL 956XL  
OE Ref:3399191R1



**1049**



Glass Bowl 9mm  
Bosch System  
(Small)  
Washer=922165

**922165**



Washer - Under  
Glass Bowl

**2722**

Throttle Cable IHC 885 XL 42  
Series 1450mm Hand Throttle



**3922**

Fuel Tank Tap IHC Brass



**59808**

Hand Primer Pump Case  
4240/John Deere 14.5 mm  
hole



**52325**

Sleeve Injector Case 1046 1055  
1056 3210 3220 3230 353 383  
385 395 4210 4220 423 4230  
433 440 454 474 484 485 495  
533 540 574 584 585  
OE Ref: 3055344R1



**Q3802338**

Injector Cummins B Series



**Q3280048**

Injector Cummins B Series



**Q3802677**

Injector Cummins 6B Series- Case  
MX100,110,12





### Fuel Lift Pumps

**52857**

Fuel Lift Pump IH 275 414 434 454



**53197**

Fuel Lift Pump IHC 743 844 745 845  
1055 1255 1455 955 1056 856 956



**1143**

Fuel Lift Pump 1294, 1394, 1494,  
1594, 1694 [OE Ref: K311939](#)



**53131**

Fuel Pump Case CS100, CS110, CS120,  
CS130, CS150, CS68, CS75, CS78, CS86,  
CS94 CVX120, CVX130, CVX150, CVX170



**7571**

Fuel Lift Pump JX60, JX65, JX70,  
JX75, JX80, JX85, JX90, JX95  
[OE Ref: 4757883](#)



**52791**

Fuel Pump Case MX / MTX  
MX100 MX110 MX120 MX135 MX150  
MX170 MTX110 MTX120 MTX135



**42067**

Fuel Lift Pump Case JXU  
[OE Ref: 2830266](#)



**51477**

Fuel Lift Pump Cummins B's -  
Diaphragm Pump Case Maxxum 5120  
5130 5140



**2641712**

Fuel Lift Pump CS48, CS52, CS58, CS63  
CX50, CX60 [OE Ref: 2641712 2641808](#)



**2641A067**

Fuel Lift Pump Phaser 4 Cylinder  
CX100, CX70, CX80, CX90 [OE Ref: 2641A067](#)



**409790**

Fuel Lift Pump Case MXM  
[OE Ref: 87802238](#)



**409790R**

Fuel Lift Pump Electric  
Case MXM LB90 LB110 LB115 555E  
655E 675E  
[OE Ref: 87802238](#)



## Water Pumps

### 2700

Water Pump IHC 1055XL 1056 1255 1455 743 744  
745S 745XL 833 840 940 946 955



### 41313201

Water Pump Case International 475



### 4345

Water Pump IHC 884 - 885 112mm Impeller 454 474 484  
685 XL 784 785 395 395XL 495 495XL 595 595XL 695 695XL  
795



### 52498

Water Pump IHC 1055XL 1056XL 1255 1455 826 886  
946 955 955XL 956 956XL 995XL c/o Air Conditioning \*\*  
112mm Impeller \*\*OE Ref: [3132676R93](#)



### 52037

Water Pump IHC 414



### 41313201P

Water Pump Case International 475



### 3853

Water Pump Case 94 Series 1290  
1390 1490



## Water Pumps

### 52477

Water Pump IHC 7100s 7200s  
8900s 9100s 9200s 9300s MX180  
MX200 MX220  
OE Ref: A77579



### 41029

Water Pump Case Maxxum  
MX Cummins Engine New  
Holland TSA / T Series  
148mm Centre Hole 78mm  
Impeller



### 52725

Water Pump IHC T6 I6  
W6 O6 400 Gas/Diesel M  
W6 Super M Super MTA  
400 W400 450 W450



### 780049

Water Pump CS Series CS78,  
CS86, CS94  
OE Ref: 354273A1



### Q2852114

Water Pump NEF Case JX1085,1095C,  
JX90-JX95, Maxxum 100-140,  
MXU100-135, MXU100-135, JXU75-  
105 OE Ref: 2852114 71104017



### 42911

Water Pump JX100 U, JX1060 C,  
JX1070 C, JX1075 C, JX55, JX60,  
JX65, JX70, JX75, JX80, JX85, JX90,  
JX95  
OE Ref: 504065104



### Q2852047

Water Pump Gasket Case Farmall  
120A,125A, 140A, JX60-95,  
JX108,JX1095C, JXU85-95-115,  
Maxxum100-140, Puma125,215,  
Puma CVT 130-215 OE Ref:  
2852047



### 41697

Water Pump Case MXM120 MXM125,  
MXM130, MXM135, MXM140, MXM150,  
MXM155, MXM165, MXM175, MXM180,  
MXM190  
OE Ref: 87384588



### 52083

Water Pump Case CX70 CX80 CX90  
CX100 Serial No JJE1008569 Up -  
97mm Impeller  
Water Pump Gasket=52084



### 43597

Water Pump Case Maxxum  
110 115 125 120 130 Puma  
CVT Series CVX Series Steyr  
Profi 6140 OE Ref: 2854835



## Cooling System

**52665**



Hose Top IH  
275

**52681**



Hose Water Pump IHC  
323 - 1046

**52666**



Hose Top IH 354 374 - 384 - 444 238

**52670**



Hose Top IH  
385 454 484

**52669**



Hose Bottom IH 385  
395 454 - 495 238  
248

**2145**



Hose Bypass IHC 414 -  
444 - 1813

**52668**



Hose Bottom IHC  
250 - 354 414 - 444  
374 384 3

**52675**



Hose Bypass IHC 250 -  
354 414 - 384 3434 238

**52680**



Hose Top IH 276  
414-434 3434

**52682**



Hose Top IH 433-633  
440-640

**52683**



Hose Bottom IHC  
433 - 833 440 -  
940 1046

**52673**

Hose IHC 454 574  
674 Water Pump



**4668**



Hose Kit IHC 474-885

**2144**



Hose IHC 474 - 895 Bottom  
1811 258-288

**2143**



Hose Radiator IHC  
474 - 885 Top 1810

## Cooling System

**52671**



Hose Top IH  
5120 - 5150

**52672**



Hose Bottom IH  
5120 - 5150

**52677**



Hose Top IH 523,  
624-645, 724-745S,  
844-845,

**52678**



Hose Bottom IH 523  
624 -645 724 -745S  
844-845

**52676**



Hose Top IH 955  
1055-1056 1246  
1255 1455

**52688**



Hose Top IH 956 1056

**52674**



Hose Water Pump IHC  
385 - 995 395 - 885  
IHC 3210 - 4230

**52667**



Hose Top IH 995  
3210 3220 4240

**52684**

Hose Top IH 1690 1594  
1694



**52679**



Hose Bottom IH  
3210 3220 3230  
4210 4220 4230

**52685**



Radiator Hose IHC  
3210 3220 4240 Top

**52686**



Radiator Hose IHC 3230 -  
4230 Top

**52687**



Hose Manifold IH CX 70-  
100 MX 80C-100C

## Air Conditioning

### 43502

Compressor Air Conditioning  
Case Maxxum Series  
OE Ref: 87709773



### 42187

Compressor Ford TM Air  
Conditioning 8160 8260 8560  
M100 M115 M135 M160 TM115  
TM120 TM125 TM130 TM135  
TM140 TM150 TM1 **MXM 140**



### 52270

Compressor Air Conditioning  
Case IH 1000s 4200 Utility  
85s 85 Utility 95 Utility CS CX  
Maxxum Series MX Series  
Combine 2344 2388



### 52232

Compressor Case IH 140  
Maxxum 100 MXU100  
MXU110 MXU115 MXU125  
MXU130 MXU135 Maxxum140  
Ford TS100A TS110A TS115A  
TS125A TS130A



### 52274

Viscous Fan Case MX100 MX110  
MX120 MX135 MTX110 MTX140



### 52266

Viscous Fan Case Maxxum Series  
5120, 5130, 5140, 5150 McCormick  
OE Ref: 5104763



### 42167

Viscous Fan MXM120, MXM130,  
MXM140, MXM155, MXM175, MXM190  
OE Ref: 82025803



### 52800

Bearing Viscous Fan  
Case MX100 MX110  
MX135 Also MX150  
MX170 MX210 MX230  
Suits Cummins Engine  
580K SK580 SK590



### 43245

Thermostat Air  
Conditioning Switch  
Case Maxxum 100  
- 140  
OE Ref: 84240633



### 42147

Fanblade MXM120,  
MXM130, MXM140,  
MXM155, MXM175,  
MXM190  
OE Ref: 82025804



### 43512

Condenser Case 1255XL 1455XL  
1056XL 956XL Air Conditioning  
OE Ref: 3402590R91



### 43514

Condenser Case JXU100U,  
JX70U, JX80U, JX 90Uir  
Conditioning OE Ref: 5166770



### 43511

Condenser Case CX MXC McCormick  
CX MC Air Conditioning OE Ref:  
222893A5



## Hoses Clips

### Original Type



Part No	Diameter (""")	Diameter (mm)
50999	5/16" - 15/32"	8-12
50998	3/8" - 5/8"	10-16
50997	15/32" - 3/4"	12-20
50996	5/8" - 1"	16-25
50995	23/32" - 1"	18-26mm
50992	7/8" - 1 3/16"	23-36
50991	1 27/64" - 1 39/64"	36-41mm
50990	1 21/32" - 1 27/32"	42-47mm
50989	1 49/64" - 1 31/32"	45-50mm
50988	1 5/16" - 2 3/8"	40-60mm
50986	2 3/8" - 3 3/16"	60-80
50985	2 3/4" - 3 1/2"	70-90

### Standard Type



Part No	Diameter (mm)	TYPE
2340SS	9.5-12	Stainless Steel
2345SS	11-15	Stainless Steel
2346SS	12-20	Stainless Steel
2357	16-25	
2357SS	16-22	Stainless Steel
2364SS	18 - 25	Stainless Steel
2394	23-35	
2394SS	25- 35	Stainless Steel
2396	28-48	
2397SS	30 40	Stainless Steel
2413SS	35-50	Stainless Steel
2426SS	45-60	Stainless Steel
2440	50-70	
2440SS	55-70	Stainless Steel
2441SS	60-80	Stainless Steel
2443	70-90	
2443SS	70-90	Stainless Steel

### Small Hose Clips

Part No	Diameter (mm)
59659	11
59660	13
59658	14
59661	17



### Heavy Duty Clamp

Part No	Diameter (mm)
51934	122 - 130
51933	113 - 121



## Radiators



**52249**  
Radiator IH B275 B414  
434  
OE Ref: 3107749R91



**52291**  
Radiator IHC B275 B414  
International 434 444  
OE Ref: 1082414R91



**52484**  
Radiator IH 323 353  
383 423 453  
OE Ref: 3131579R91



**52375** Radiator IH Early 248-  
484,845-885 & XL 595-995 &  
XL - Late Type 52126 52165 is Up  
to 1987



**52165** Radiator IH Early 248-  
484,485-885 & XL 595-995 &  
XL - (Late Type 52126) \*\* Up  
to 1987 \*\*



**52126** Radiator IHC Late  
268,88,485-885 & XL 595-  
995 Early Type is 52165  
Cap = 52020



**52770**  
Radiator IH 956 1056 XL



**52248**  
Radiator IH 1255 - 1455  
OE Ref: 3226796R92



**52771**  
Radiator IH 5120 5150



**52772**  
Radiator IHC MX100 MX110  
MX120 MX135 MX150 MX170  
4 Row IH rad





**41886**  
Radiator Case MXM175,  
MXM190  
OE Ref:87352193



**43487**  
Radiator MXM120,  
MXM130 OE Ref:  
87352188



**43001**  
Radiator JX100 , JX80 U,  
JX90 U OE Ref: 5169275



**52246**  
Radiator Case CX50 60  
70 80 90  
OE Ref: 222890A5

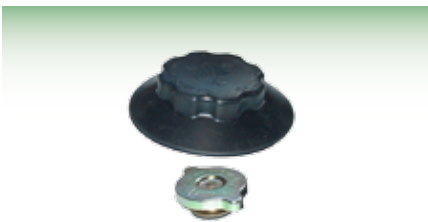

**52020** Radiator Cap IHC c/o  
Cover



**52133** Radiator  
Cap IHC Round



**42029**  
Radiator Case  
MXM175, MXM190  
OE Ref: 87306788



**4398** Thermostat c/o Pin  
Case CX100, CX70, CX80,  
CX90 MX100, MX100 C,  
MX80, MX80 C, MX90,  
MX90 C



**59551**  
Thermostat Switch Case  
1594, 2294, CX100, CX80,  
5150, 1896, 2096



**43598**  
Thermostat Case Puma CVX Puma CVT  
Maxxum Series Steyr 4120 Profi 4130  
4135 4145 4125 4110 OE Ref: 84322388

Date:.....

No. of Pages:.....

Name of the Rep.....

A/C Number:.....

From:.....

e-mail.....

Phone No.:.....

Fax No.:.....

Please quote for the following parts - Quotation Number :

I wish to confirm the following order on Quotation Number:

Please supply the following parts:

Qty	Part No.	Description	Unit Price
1.			
2.			
3.			
4.			
5.			
6.			
7.			
8.			
9.			
10.			
11.			
12.			
13.			
14.			
15.			
16.			
17.			
18.			
19.			
20.			
21.			
22.			
23.			
24.			

Please photocopy this page

Please do not remove this page

Comments:

Customer Signature:

Rep's Signature:

Tel No: + 353 44 934 1638

e-mail: [info@qtponline.com](mailto:info@qtponline.com), [www.qtponline.com](http://www.qtponline.com)

Page  of

# Fan Belts



Part No	Models	OE Ref	Size
<b>1509</b>	Fan Belt IHC 474 784	3616512M91	3X1550
<b>6766</b>	Fan Belt Pair Case 654,724,824,946,1046,1246,956,1056,553,523	3381364M91 3581611M1	
<b>52002</b>	Fan Belt Case 956/1056 w/o Air Conditioning	3218952R1	13 x 1420
<b>6898</b>	Fan Belt Pair 4240	3582953M91	
<b>52006</b>	Fan Belt Case 4240	1537104C1	13 x 1595
<b>62963</b>	Fan Belt Case 7455,383,423,440,453,540,640,740,743,743XL,323,745 XL,840,844 S, 844XL,845,856XL,940	3144678R1	
<b>52000</b>	Fan Belt Case Maxxum 5120 5130 MX 100 135 (1498mm) MX 100 - 135	J911558	
<b>52000G</b>	Fan Belt Case Maxxum 5120 5130 MX 100 - 135 8PK1495	J911558	
<b>52085</b>	Air Con Belt Case CX70 CX80 CX90	228332A2	
<b>59368</b>	Fan Belt Case IH 323 383 423 453 484 540 640 740 743	3144678R1	
<b>52776</b>	Fan Belt Case C90 CX90 C100 CX100	241895A2	10 X 1415
<b>52775</b>	Fan Belt Case Magnum 7120 7150 7210 7250 8PK1700	J911567	
<b>52774</b>	Fan Belt Case MX150 MX170 - 5130 5140 5150 8PK1460	J911558	
<b>43207</b>	Fan Belt Ford TM120 130 140 155 175 190, also	87802822	
<b>41635G</b>	Fan Belt Case Magnum Series, Maxxum Series, MXU Series	4899178	
<b>43128</b>	Fan Belt New Holland TLA T4 T5 Case JX JXU JX	47131754	
<b>7312</b>	Fan Belt Case JX55, JX60, JX65, JX70, JX75, JX80, JX85, JX90, JX95		

## Fan Belt Tensioner

### 52221

Fan Belt Tensioner Case IH 5120 5130 5140 5150  
5220 5230 5240 5250 7110 7120 7130 7140 7150  
7210 7220 7230 7240 7250 8910 8920 8930



## Air Filters

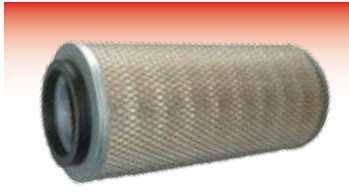

**2478**  
Air Filter IHC 1056XL Outer

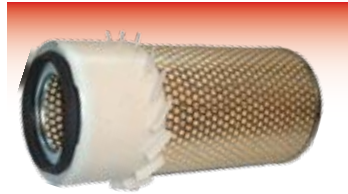

**1659**  
540/84/85/585 XL, 585/95  
Utility Series/B Series  
Outer Air Filter



**3280**  
Air Filter IHC Outer 2140 2150  
OE Ref: 3031563R1 3124338R1

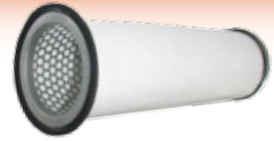

**3275**  
Air Filter IHC Inner

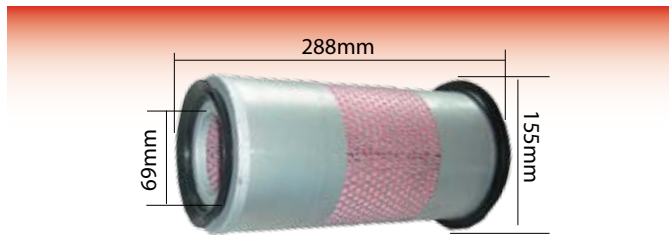

**1681**  
Air Filter IHC 885XL Without Hole Also Hymac 370, 370C



**4827**  
Air Filter Case IHC  
4200 (Inner 1101)



**1101**  
Case IHC 4200'S  
Inner Air Filter

### JX

#### Filter Kit

**7330**  
Air Filter Kit JX Series  
JX95

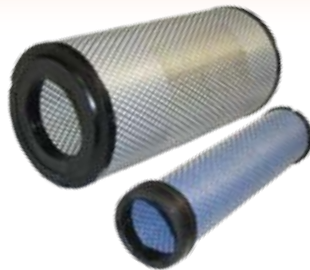

### CS



**52332**  
Air Filter Outer Case CS80 94  
78 100 90 86 Inner Filter is  
52328 OE Ref: 354308A1



**52328**  
Air Filter Inner Case CS78 CS80  
CS86 CS90 CS94 CS100 Outer  
Filter 52328 OE Ref: 354309A1



**7123**  
Air Filter Outer Case JX55-  
JX1060, AVJ55,60,70,  
VJ60,70,80  
Inner is 7125 OE Ref: 1930587



**7125**  
Air Filter Inner Outer Case  
JX55-JX1060, AVJ55,60,70,  
VJ60,70,80 Outer is 7123  
OE Ref: 1930588

### CX

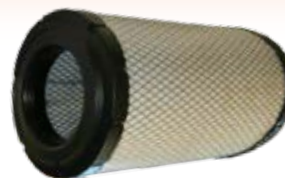

**53380**  
Air Filter Outer CX Series  
CX110



**53379**  
Air Filter Inner CX Series  
CX110

**7033**  
Case Cx70  
/80/90/100/Jx95  
Mx100c/Mx115c  
Outer Air Filter



## Air Filters

### Maxxum



**61203**  
Air Filter Case Maxxum 5150



**52229**  
Air Filter Inner Case Maxxum 150 2094 5150 5250  
OE Ref: A47033



**4896**  
Air Filter Case Maxxum Outer 5130 5140

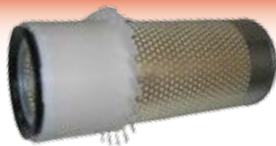

**26510229**  
Air Filter Outer Case Maxxum 5120, 5130, 5140, 5220, 5230, 5240 MX Series MX100, MX100 C, MX110, MX80, MX80 C, MX90, MX90 C OE Ref: 3621282



**41256**  
Air Filter Case Mx100-MX170  
OE Ref: 87682992

### MXV Filter Kit



**41518**  
Air Filter Kit Case MXV100, MXV110  
OE Ref: 82034604 & 87682992

### MXM 41099 - Filter Kit

**402818**  
Case Mxm130/140/155  
Outer Air Filter

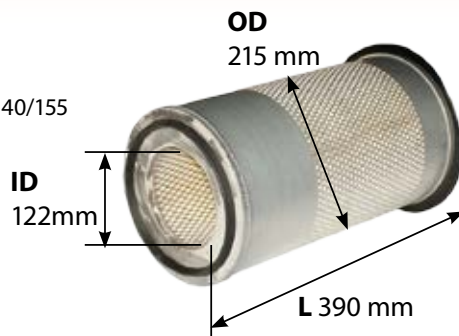

**402819**  
Case Mxm130/140/155  
Inner Air Filter

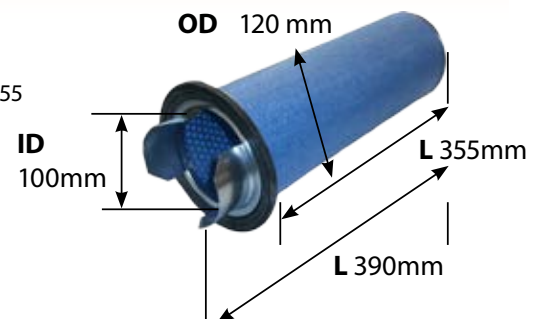

### CVX/CVT



**52341**  
Air Filter Outer Case CVX  
\*\* Inner is 52329 \*\*OE  
Ref: 162000190700

**52329**  
Air Filter Inner Case CVT 150 170 130 120 6130 6160 6155 6150 6145 6135 6140 6165 61956175 CVX1155 1145 1135 1170 1190 1195 120 130  
OE Ref: 162000190710

### Magnum / Steiger



**52356**  
Air Filter Outer  
Case Magnum 215 245 275 305 330 335 Steiger 280 330 335 Patriot 4420 STX275 STX325 STX275 STX325 Ford T8000 Series T9000 Series OE Ref: 367349A1

**52357**  
Air Filter Inner  
Case Magnum 215 245 275 305 330 335 Steiger 280 330 335 Patriot 4420 STX275 STX325  
OE Ref: 367350A1

## Cab Air Filters

### 52384

Cab Air Filter Case CS110 CS150 CS78  
CS94 CVX1135 1145 1155 1170 1190  
1195 120 130 150 170

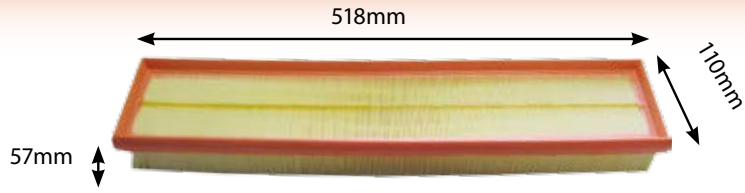

### 42177

Cab Air Filter JX

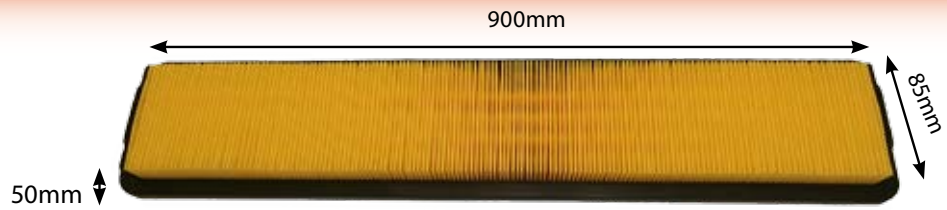

### 43339

Air Filter Cab Case JX1060C JX1070C  
JX1075C JX1085C JX1095C  
OE Ref: 47129134



### 52260

Cab Air Filter Case CX50 - 100 MX100  
- 170 McCormick CX50 - 100 MC100 -  
135 MTX110 - 200

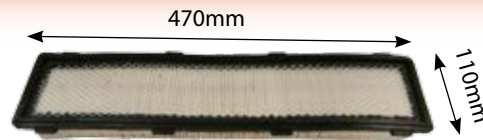

### 52261

Cab Air Filter Case CVX MXU Puma

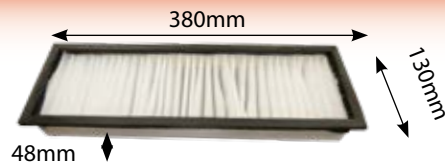

### 42178

Cab Air Filter Case Puma, Steyr, CVT ,CS,  
CVX, Maxxum  
OE Ref: 82034664

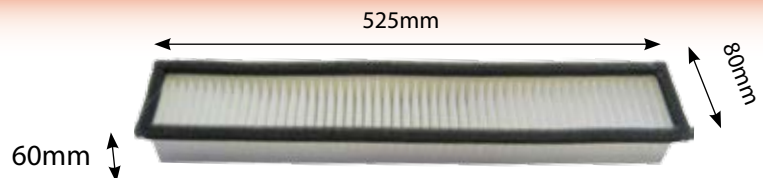

### 43506

Pre Filter Cab Air Filter Case  
JXU MXM OE Ref: 83994694



### 43680

Cab Air Filter Case Maxxum  
MXU Steyr Profi OE Ref:  
87726696



## Cab Air Filters

### 52462

Cab Air Filter Case MXM120 MXM130  
MXM140 MXM155 MXM175 MXM190  
TS110 TS115 TS90 [OE Ref: 82034661](#)



### 52469

Cab Air Filter Carbon Pesticide  
Case CX100 CX50 CX60 CX70 CX80  
CX90 MX100 MX110 MX120 MX135  
MX150 MX170 [OE Ref: 713409A1](#)

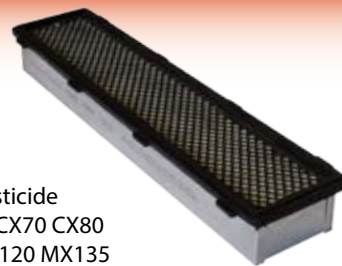

### 52468

Cab Air Filter Carbon Pesticide Case JX100  
JX1080U JX1090U JX1100 JX55 JX65 JX70U  
JX75 JX80U JX85 JX90U JX95 Fiat G190  
L60L65 L75  
[OE Ref: 5097838](#)

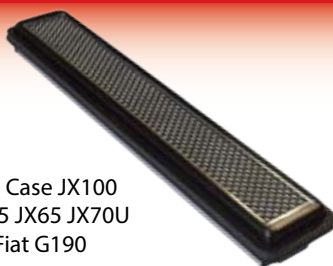

### 52464

Cab Air Filter Carbon Pesticide Case  
CS100 CS110 CS120 CS130 CS150  
CVX1135 CVX1145 CVX1155 CVX1170  
CVX1190 CVX1195 CVX120 CVX130  
[OE Ref: 134684036](#)

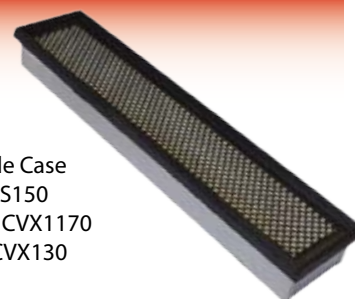

### 52467

Cab Air Filter Case JX1060C JX1070N  
JX1075N JX1075V Ford TN55V TN60VA  
TN65V TN70VA TN75V TN95VA  
[OE Ref: 44910397](#)



### 43682

Cab Air Filter Case JX [OE Ref: 44911740](#)



CHARCOAL FILTER - CHEMICAL APPLICATION

### 52465

Cab Air Filter Case JX 1060C JX1070C  
JX1075C JX1085C JX1095C  
[OE Ref: 47131906](#)



### 43669

Cab Air Filter New Holland T4 T5 Series  
Case Farmall Series Steyr Kompakt Series  
[OE Ref: 84577445](#)



### 52466

Cab Air Filter Dust McCormick CX65L  
CX75L CX85L C105 Max C60 Max C75  
Max C85 Max C95 Max  
[OE Ref: 3677515M91](#)



### CARBON

### 52463

Cab Air Filter Carbon Pesticide  
McCormick CX65L CX75L CX85L C105  
Max C60 Max C75 Max C85 Max C95  
Max

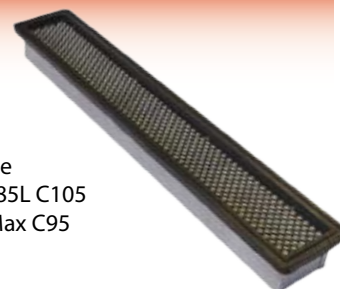

## Oil Filters

### 1685

Engine Oil Filter  
Case IH  
474, 585, 585XL,  
685, 685XL



### 1678

IHC 884  
Spin On Oil Filter



### 1678G

Engine Oil  
Filter IH 884  
946 1046 955  
& XL



### 52211

Oil Filter IHC 340 422 1455 1256 1456  
656 756 856 460 660 340 560 660  
706 756 806 826 1206 21026 21256  
2500 2504 2606 2656 2706 2756



### 52334

Oil Filter Case 1194, 1294, 1394,  
1494, 1594, 1694  
[OE Ref: K200037](#)



### 52287

Oil Filter Case 3088 3288 3230 3210 3220  
4210 4220 656 756 856 666 766 574 584 684  
784 884 385 485 685 785 885 585 686 786  
886 395 495 [Oe Ref: 3136046R91](#)

### 3600



Engine Oil Filter IHC 1056 4200

### 52222



Oil Filter Case JX90 Ford TD90



### 52286

Oil Filter Case 523 554 624 724 824 633  
733933 740 840 743 644 744 844 745 845  
826 533553 743 744 745 826 846 Fendt  
Farmer 102 103  
[OE Ref: 3059134R91](#)



### 52033

Oil Filter Case CS's



### 52746

Engine Oil Filter Case CS68, CS75  
[OE Ref: V836462576](#)



### 1460

Engine Oil Filter CS68, CS75  
[OE Ref: 836436246 Valmet](#)



## Oil Filters



**6978**  
Case Cvx130/150  
Oil Filter



**2654403**  
Case Cx50/60/70/  
Oil Filter



**2654403S**  
Engine Oil Filter 212 248  
4000 5000 PerkinsCX50,  
CX60, CX70  
OE Ref: 3118119R1



**52076**  
Oil Filter Case  
CX70



**27235**  
Engine Oil Filter Case  
CX50,CX60,CX70  
OE Ref: 83963906  
83947506



**3670S**  
Engine Oil Filter Case JX  
Series JX55, JX65, JX75,  
JX85, JX95  
OE Ref: 1909102 1931165



**3670G**  
Engine Oil Filter Case JX  
Series JX55, JX65, JX75,  
JX85, JX95



**41257**  
Engine Oil Filter MXU Series  
MXU100, MXU110, MXU115,  
MXU125, MXU135



**52007**  
Engine Oil Filter Case  
Maxxum 5100 MX110-175



**4906G**  
\*\* USE 52007 \*\*ne



**404130**  
Case Mxm130/140/155/175/190  
Engine Oil Filter



**2654407**  
Case Cx80/90/100  
Mx100c/Mx115c  
Oil Filter



**4898**  
Engine Oil Filter Case 580K/  
Maxxum



**1248**  
Oil Filter Magnum Series  
7110, 7120, 7130, 7140  
OE Ref: 4206089

**52358**  
Oil Filter Spin On Case  
Magnum 215 225 245  
250 275 280 305 335  
7110 7210 7220 7230  
7240 7250 8910 8920  
8930 8940 8950 MX180  
MX200  
OE Ref: 87349575



**52364**  
Oil Filter Spin On  
Case Steiger 380  
385 430 435 485  
AFX8010 STX380  
STX485 STX530  
Ford FX30 FX40  
T9030 T9040 T9050  
OE Ref: 84818743



**52363**  
Oil Filter Spin On Case  
Steiger 480 530 535  
STX375 STX380 STX425  
STX440 STX450 STX485  
STX485 STX500 STX530  
Ford T9050 T9060 John  
OE Ref: 324617A1



## Fuel Filters

**3082B**



**3082G**



**3082**



Fuel Filter 32/33/4200 Utility/43/44/46/540/55/56/74/84/85/85 Utility/95 Utility/995 XL/CX Series/MX Series

**1782**



**1782B**



OE Ref: 3405418

**41751**

Fuel Filter In Line Short Gauze Type



**41750**

Fuel Filter Large In Line Gauze Type



Fuel Filter

Case IH 654, 724, 824 433, 633, 733, 833 743 XL, 743 644, 744, 844 XL, 844 946, 1046, 1246 946, 1046, 1246 385, 485 XL, 485, 685 XL, 685, 785 XL, 785, 885 XL 585 XL, 585 B275, B276, B414, B434 CX50, CX60 354, 444, 454, 474, 475, 484, 533, 553 323, 423 383

**26566602G**

Fuel Filter Case

CS100,110,120,130,150,78,86,94

OE Ref: 1896287M91



**49185**

Fuel Filter

CS100, CS120, CS130, CS150, CS80, CS90,

CVX120, CVX130, CVX150, CVX170



**52079**

Fuel Filter Case CX70 CX80 CX90 In Line

Fits All CX and MX and 51 Series



**4230G**

Engine Oil Filter CX Series

CX50, CX60, CX70

OE Ref: 84284907

86546614 83



**2723G**

Engine Oil Filter Engine Oil Filter CX50, CX60, CX70, C50- C90

OE Ref: 83963906 83947506



**26561117G**

Fuel Filter Agco Genuine Case CX50/60



**51891**

Fuel Filter Water Separator

Case CS Series & CVX120,130,150,170

OE Ref: 836859302



## Fuel Filters



**52701**  
Fuel Filter Case IH JX1090U -  
Water Separator



**409666**  
Fuel Filter 5 Micron  
JX1090U from 2008



**26566602**  
Fuel Filter Case CVX  
120/130/150/170



**51893**  
Fuel Filter Water Separator  
Case CVT6135, CVT6145,  
CVT6155, CVT6170, CVT6190  
OE Ref: 20366575



**7588**  
Fuel Filter Case JX100 U, JX55, JX60,  
JX65, JX70, JX70 U, JX75, JX80, JX80 U,  
JX85, JX90, JX90 U, JX95  
Thread M14 X 1.5 - Height 115mm  
OE Ref: 1930581



**41611**  
Fuel Filter Case MXV110, 115,120,  
125,130,135  
OE Ref: 87803180



**41862**  
Fuel Filter Case MXV110,115,120,  
125,130,135  
OE Ref: 87803192

**409665**

**SHORT**



Water Separator (30 Mic) Fuel  
Filter Secondary MXM120,  
MXM130, MXM140, MXM155,  
MXM175, MXM190

**409665L**

**LONG**



Water Separator (30 Mic)  
Fuel Filter Secondary  
MXM120, MXM130, MXM140,  
MXM155, MXM175, MXM190



**401112**  
Fuel Filter MXM155, 140,175,190  
Suitable for Electric Fuel Lift Pump  
OE Ref: 87801341 87802332

**409709**

Fuel Lift Pump Electric  
MXM series



**53685**

Fuel Filter Change  
Indicator Mounted Prior  
To Supply Pump



## Fuel Filters



**4917S**  
Fuel Filter CS100, CS80,  
CS90, CVX135-CVX190,  
MXM120-MXM190  
OE Ref: 26560141



**4917**  
Fuel Filter CS100, CS80,  
CS90, CVX135-CVX190,  
MXM120-MXM190  
OE Ref: 26560141



**401111**  
Fuel Filter MXM  
130,140,120,175,190,155  
OE Ref: 87802927



**51892**  
Fuel Filter Water  
Separator Case IH  
MXM Series OE Ref:  
20366577



**41094**  
Fuel Filter Case MXM Series  
OE Ref: 87802728



**4899**  
Fuel Filter Water Separator  
Maxxum Series 5120, 5130,  
5140, 5150, 5220, 5230, 5240,  
5250



**4903**  
Fuel Filter Case 51 Series



**52359**  
Fuel Separator Spin on Case  
Magnum T8010 -  
OE Ref: 87356194



**52366**  
Fuel Filter Spin On Case Magnum  
215 245 275 305 335 MX225  
MX250 MX280 MX285 MX310  
Steiger 280 330 Ford T8010  
T8020 T8030 T8040 T9010 OE  
Ref: 87360565



**41254**  
Fuel Filter Case MXU110-  
125-135, Puma 115-210  
Series  
SECONDARY FILTER OTHER  
FILTER 41611  
OE Ref: 87803197



**52360**  
Fuel Separator Spin on  
Case Steiger 480 530 535  
STX380 STX485 STX530  
OE Ref: 87366406



**52361**  
Fuel Separator Spin On Case  
STX380 STX485 STX530  
OE Ref: 87410186



**52362**  
Fuel Filter Spin On Case Steiger  
380 385 430 435 485 AFX8010  
STX380 STX530 OE Ref: 84818744

## Hydraulic Filters

**1676**

Hydraulic Filter IHC 785 885XL



**1964**

Hydraulic Filter Case 885XL,  
885 OE Ref: K920522



**2178**

Hydraulic Filter Case  
1494,1594,1694 OE Ref: K210049



**4829**



Hydraulic Filter Case  
IHC 4200 CX50 CX60  
CX90

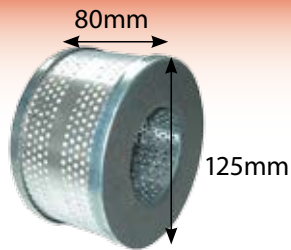

**7320**

Case JX55/65/75/85/95 P/S



**52699**

Hydraulic Filter Case IH JX1090U  
New Holland TLA



**4904**

Hydraulic Filter Case MX80-135 51  
MX80-120 5200's McCormick MC80-  
115 MTX110-155



**404912**

Hydraulic Filter Case MX180,190,200,2  
10,220,230,240,250,260,270  
OE Ref: 82003166



**52080**

Hydraulic Filter Case  
CX70 80 90 Hyd/Trans  
Ring=53124



**43341**

Hydraulic Filter Case 1056 1255  
1455 740 743 745 745S 840 844  
844S 845 856 940 956  
OE Ref: 1328276C2



## Hydraulic Filters

### 52330

Filter Hydraulic Transmission Case  
CVT120 170 150 130 120 CVT6160  
6155 6150 6145 6135 6140 6170 6175  
6190 6195 CVX1135 1145 1155 1170  
OE Ref: 47436570



### 52289

Hydraulic Filter Case  
MX150 MX170



### 52340

Element Hydraulic Filter Case CVX New  
Holland T7510 T7520 T7530 T7540  
OE Ref: 192200280705



### 52339

Element Hydraulic Filter Case CVX  
New Holland T7510 T7520 T7530  
T7540  
OE Ref: 192310280011



### 404893

Hydraulic Filter Case  
CS, CVX, MXM, MXV  
OE Ref: 81863799



### 52518

Hydraulic Filter  
Case CS 68 75 76 94 C 55 64 70  
OE Ref: 133700730095



### 52520

Hydraulic Filter Case  
955 C, CS Series  
OE Ref: 13770075006



### 42122

Hydraulic Filter Secondary Case CVT,  
Maxxum, Puma  
OE Ref: 87708150

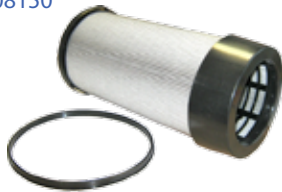

### 41260

Hydraulic Filter -  
Maxxum,  
MXM, MXU, STX, Puma  
Series  
OE Ref: 87404986



### 402820

Hydraulic Filter Maxxum  
Series  
MXM Series, MXU Series  
OE Ref: 84248043



### 41258

Hydraulic Filter Secondary  
MXM175, MXM190, MXU100,  
MXU110, MXU115, MXU125,  
MXU135  
OE Ref: 84226260



### 52336

Hydraulic Filter Case MX  
Maxxum MX150 MX170  
OE Ref: 177356A1



## Filters Kits

Part No	Description
52059	Filter Kit Case Maxxum 5110/20/30
52060	Filter Kit Case Maxxum 5140 5150
52058	Filter Kit Case 42's



## Coolant Filters

### 4905

Water Coolant Filter Ford/  
Case Maxxum 885xl



### 4905G

Water Coolant Filter Ford/  
Case 885/Maxxum



## Filter Transfer Pump

### 52205

Filter Transfer Pump Case CX



## Wheel Hubs



**1648**

Wheel Hub IHC 574 Standard Duty Front Nut 1/2" UNF Stud 2 x 1/2 UNF Press in



**2531**

Wheel Hub IHC 684 885 Front Heavy Duty Nut for this hub is 195490



**52713**

Wheel Hub IHC 956 Front



**52717**

Wheel Hub IHC 444 B275 B414

**52716**

Wheel Hub IHC 885 784



**52733**

Hub Cap IHC B275



## Ware Ring IH Front Wheel Hubs

**52722**

Ware Ring IHC 444 414 Front Wheel Hub Fits IHC 654 674 684 B275 B276 B434



**52743**

Ware Ring IHC 238 248 258 268 Front Wheel Hub 288



**52744**

Ware Ring IH Front Axle Steering 238 248 258 395



**59134**

King Pin APL3052 3054 John Deere Case Ford



**59148**

Pivot Housing APL315 315N 325 325N LH John Deere Case



**59147**

Pivot Housing APL315 315N 325 325N RH John Deere Case



**59146**

Pivot Housing APL345 350 LH John Deere 3040 3140 3050 3350



**42980**

Pivot Housing APL345-350 LH Ford Case



**59149**

Carrier Housing APL1551-1552 John Deere Case



**52496**

Right Hand Carrier Housing Case MX100 MX110 MX120 MX130 MX100C MX80C MX90C  
OE Ref: CAR140880



**52497**

Left Hand Carrier Housing MX100 MX110 MX120 MX130 MX100C MX80C MX90C  
OE Ref: CAR140879





## High Spindles

**3829**



Wheel Bearing Kit IHC  
475 454 484

**LM68149/11**



Bearing for Kit IHC 454-584 KIT  
3821 ID 35mm OD 60mm Depth  
16.76mm

**3821**



Wheel Bearing Kit IHC  
668 784 785

**530104**



Hub Seal IHC 475  
For 3829 Kit

**LM102949/10**



Bearing for Kit IHC 688/784  
Kit = 3821

**370254**



Hub Seal For 3821 Kit IHC  
668 Case CX Also Case  
CX70/80/90  
Kit = 3821

**52405**



Spindle Bearing Case 323 353  
383 423 523 624 654 724 433  
633 733 440 640 740 644 744  
844 745 845 540 856 533 553  
744 745 OE Ref: 3057058R91

**527295**



Stub Axle Bearing IHC  
684/784 (wont suit  
685) also 585

**52012**



ZF Front Half Shaft Bush  
Inner IHC/Case

**3763**



Spindle Bush IHC 454 474  
475 574 674 484 584 684  
784 884 385 485 & XL 585 &  
XL 685 & XL 785 & XL 885

**1679**



Hub Cap IHC 238 - 288 454  
- 884 595 - 995 XL CX50 -  
MX90

**2254**



Spindle IHC 684 685 784  
785 884 885  
28cm Long

**2284**



Spindle IHC 474 574 584 Standard  
Duty 39cm Long 42mm thick  
454/475/484/485/585/595/674

**2285**



Spindle IHC 474 574 584  
Heavy Duty 39cm Long  
454/475/484/485/585/595/674

## Orbital Units

M18



**1447**

Orbital Unit 300 3000 - 100  
OSP

100 OSP M18

M18



**6907**

Orbital Unit 300 3000  
125 OSP M18 Thread

125 OSP M18

3/4 JIC

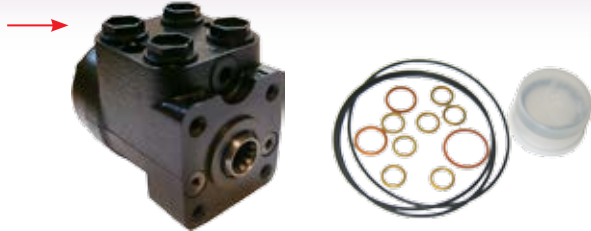

**4655**

Orbital Unit c/o Relief Valve  
3/4 JIC 100 OS

100 OSP 3/4" JIC

**4564**

Orbital Unit Seal Kit to Suit  
4655

M18



**4605**

Orbital Unit Ford 40 TS 4WD  
M18 -12 Spline 24.25mm  
Diameter 20mm high

150 OSP M18

3/4 JIC



**51051**

Orbital Unit 200  
OSP 3/4 JIC

200 OSP 3/4" JIC

1/2" JIC



**4857**

Orbital Unit John Deere  
160 OSP (40 Series)

175 OSP 1/2" JIC

## Orbital Units

<p><b>52184</b></p> <p>Orbital Unit Case MXU Puma JX JXU Maxxum Ford 35 60 TL L MTTL Series TLA TM TSA TSA Series STZ0R125M170</p> <p>175 OSP M22</p>	<p>M22 →</p>	<p><b>7808</b></p> <p>Orbital Unit Fiat 56 88 90 93 94 Series 100 OSP 1/2" BSP</p> <p>100 OSP 1/2" BSP</p>	<p>1/2" BSP →</p>
---	--------------	--	-------------------

<p><b>1504266</b></p> <p>Orbital Unit Repair Kit IHC/Massey Ferguson/DB</p>	<p>1/2" BSP →</p>	<p><b>52207</b></p> <p>Orbital Unit Kit Case ZF 43 743XL 44 844XL 45 845XL 55 955XL 1055XL 1255XL 1455XL 56 856XL 956XL 1056XL 85 485XL</p>
<p><b>1810503</b></p> <p>Orbital Unit Repair Kit</p>	<p><b>4620</b></p> <p>Orbital Unit Fiat 2 Ram Axle 160 OSP 1/2bsp Also fits Zetor</p> <p>160 OSP 1/2BSP</p>	

<p><b>4600</b></p> <p>Steering Column Assembly Hydrostatic 830mm</p>	<p><b>52818</b></p> <p>Power Steering Shaft Fits all models</p>	<p><b>62292</b></p> <p>Orbital Unit Fitting Kit 675 -698 French Type</p>
--	---	--

## IHC Early 2WD Axle

**53192**

Bearing Steering IHC  
384 444 B275 B414



**52395**

Track Rod Case 3210 3220 4210  
4220 4230 4240 574 584 684 784  
884 385 485 485XL 685 685XL  
785 785XL 885 885XL 585 585XL  
395 395XL 495



**52703**

Bush Front Axle IH 433  
- 1455 2WD



**3098**

Track Rod End IHC  
684 784 884 Push in  
Fits 685 685 XL 785  
785 XL 885 885 XL



**3914**

Track Rod End IHC  
Screw in

**3754**

Wheel Stud IHC Front 238 -  
995XL 195490 is nut to suit  
McCormick CX50 - CX100

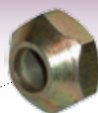

**195490**

Wheel Nut 135 165  
Front (1/2" UNF) IHC  
238 - 995XL

**2279**

Wheel Stud IHC 574 674  
Rear 5/8 UNF x 2

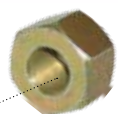

**881162**

Wheel Nut 165 Rear  
Wide 5/8" UNF

**2531**

Wheel Hub IHC 684 885  
Front Heavy Duty Nut for  
this hub is 195490



## IHC Early 2WD Axle

### 196049

Bush Front Axle - Front IH 385 485 485 585 685  
785 885 & XL 474 475 574 674 484 584 684 784  
884 & CX  
OE Ref: 405570R1

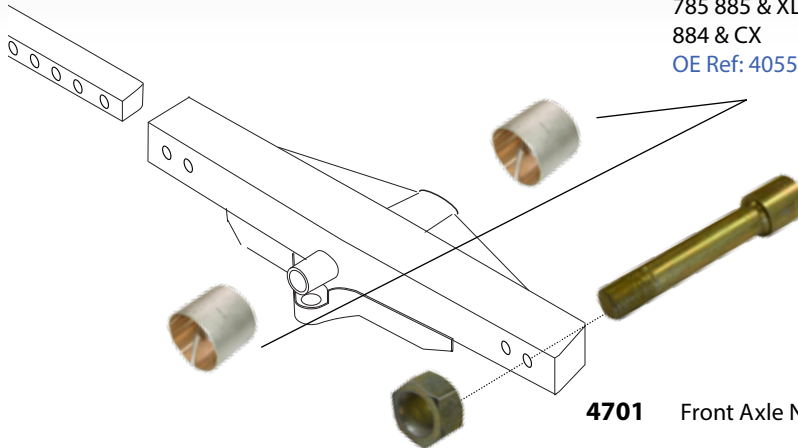

### 4702

Front Axle Bolt IHC

### 4701

Front Axle Nut IHC 238 - 995XL

### 51118

Power Steering Ram  
IHC 584-42 2WD

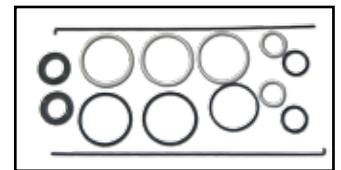

### 51360

Seal Kit to suit 51118  
(IH & McCormick)

### 1123

Bush for 2330 Bracket  
IHC



### 51937

Clevis End Power Steering Ram IHC  
584-42 2WD

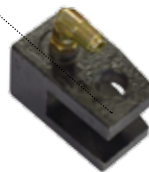

### 2330

Bracket Power Steering  
IHC 784



### 3057



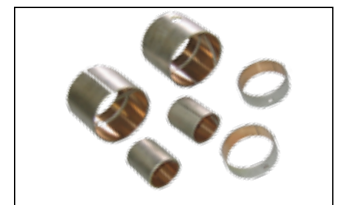

Bush Power Steering IHC 684  
Goes with 2330 \*\* Kit is 52065 \*\*





### 52065



Front Axle Bushing Kit Case  
884 885 C CX

## Track Rod Ends 4WD

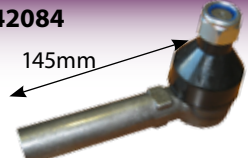
 <p><b>2824</b> 208mm Track Rod End Case Maxxum RH</p>	 <p><b>3144</b> 24R Ball Joint Ford 8210 Carraro 4WD MX Maxxum Massey Ferguson 3000 &amp; 6100</p>	 <p><b>2825</b> 22R Ball Joint Case Maxxum Ford 40</p>	 <p><b>2839</b> 208mm Track Rod End Case Maxxum LH</p>
---	---	--	---

 <p><b>6829</b> Track Rod End MX Series <a href="#">OE Ref: 3764024M1</a></p>	 <p><b>3144</b> Ball Joint Ford 8210 Carraro 4WD MX Maxxum Right Hand Thread <a href="#">83957792</a> <a href="#">83957096</a></p>
--	---

 <p><b>780146</b> Track Rod End Renault 12-14 50-12V 55-12V 70- 80-12V Dionis 110 120 130 140</p>	 <p><b>42084</b> 145mm Track Rod End Case IH CS78 CS86 CS94 LH/RH Steyr M968 M975 9078 9086 9094</p>	 <p><b>52010</b> 255mm Track Rod End IHC ZF 4WD</p>	 <p><b>52011</b> 22R 20R Ball Joint IHC ZF 4WD</p>
---	--	--	--

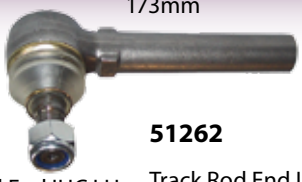
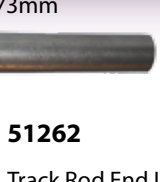
 <p><b>51255</b> 20R 22R Ball Joint IHC 956 1056</p>	 <p><b>4255</b> 20R Ball Joint Ford 10 Carraro Axle LH LH Thread</p>	 <p><b>6463</b> 18L Ball Joint 300 4200 Ford 4WD New Type</p>	 <p><b>51263</b> 173mm Track Rod End IHC LH Carraro Outer 895 995 4210 4220 4230 4240 CX50 CX60</p>	 <p><b>51262</b> Track Rod End IHC RH Carraro Outer 895 995 4210 4220 4230 4240 CX50 CX60</p>
---	---	--	--	--

 <p><b>52219</b> Track Rod End IH B250 B275 276 354 374 384 B414 434 444 Industrial 238 2350A 2WD Manual Steering Front</p>	 <p><b>52220</b> Track Rod End IH B250 B275 276 354 374 384 B414 434 444 Industrial 238 2350A 2WD Manual Steering Rear</p>	 <p><b>52217</b> Track Rod End IH B250 B275 276 354 374 384 B414 434 444 Industrial 238 2350A 2WD Manual Steering LH</p>
--	---	--

## Front Axle Parts

**42150**



Bearing Front Axle 4WD Ford 30s Carraro Axle Case CX Carraro Axle McCormick CX Carraro Axl CAR707 Axle OD 47mm ID 25mm (Bottom)

**42149**



Bearing Front Axle 4WD Ford 30s Carraro Axle Case CX Carraro Axle McCormick CX Carraro Axl CAR707 Axle (Top)

**4805**



Stub Bearing 4 WD ZF 325 ID 22.5 47 OD

**M86649/10**

Stub Axle Bearing



**52314**

Suspension Axle Link Pin Case MX100 MX110 MX120 MX135 CVX120 CVX130 CVX150 CVX170 Carraro 40mm Diamter 140mm Length Axle Number OE Ref: [3656956M1](#)



**52017**



ZF Axle Gear Case IH 485-995 (APL330)

**52394**



Wheel Bearing Case CX McCormick

**52391**



Bush Front Axle Case CX McCormick

**52434**

Ring Gear Case 258 268 288 395 485 585 685 785 885 485XL 495XL 585XL 595XL 685XL 695XL 785XL 795XL 885XL 895XL 995XL OE Ref: [4472352015](#)



**52430**

Front Axle Joint Assembly Case 5220 5230 5240 5250 CS100 CS110 CS120 CS130 CS150 CS68 CS75 CS78 CS86 CS94 Ford 5640 6640 7740 7840 8240 OE Ref: [81863155](#)



**52429**

Front Axle Joint Assembly Case 395 495 495XL 795 795XL 895 CX70 CX80 CX90 CX100 MX100 MX90 MX80 OE Ref: [1537637C1](#)

## Front Axle Parts

**52016**

ZF Axle Shaft Case IH 485-995 (APL330)



**59291**

Coupling McCormick 4WD



**43554**

Axle Coupling Middle  
OE Ref: 5183663



**52379**

Seal 4WD Shaft Case  
MX135 Transmission End



**52831**

Seal Case IHC Carraro Axle  
Large Hub Seal 130 x 160 x  
14.5 mm



**52304**

Seal Case IHC 3230 3210 3220 4210  
4220 4230 4240 395 - 895 395XL -  
895XL CX50 - CX100  
OE Ref:83983369



**52305**

Seal Case IHC 3230 3210 3220 4210 4220  
4230 4240 395 - 995 395XL - 995XL CX50  
- CX100  
OE Ref:100529A1



**43542**

Drive Shaft Seal Ford 6000s TMs TSs TSAs  
Case MXM Series 42 x 62 x 21.5mm OE Ref:  
12016507B5177709



**409822**

Front Axle Ware Sleeve Case  
Carraro CX70/80/90  
ID 104.8mm, OD 114.9mm



**409821**

Front Axle Bush Carraro 125  
x 40mm OE Ref: K965265



**43258**

Thrust Washer Front Axle  
Case CS CX MX  
OE Ref: 3541397M1



**43679**

Drive Shaft 4WD Hi/Lo or Manual Transmission  
Case MXM Ford OE Ref: 5168037

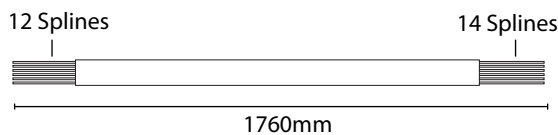

**7587** - Coupling 12 Spline

**7507** - Coupling 14 Spline



**43094** - Support

**6912** - Bearing & Carrier





# Front Axle Parts

**60003**

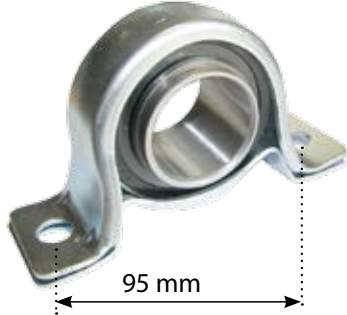

Shaft Drive Carrier & Bearing Kit  
IHC 4WD Bearing ID 32mm

**59974**

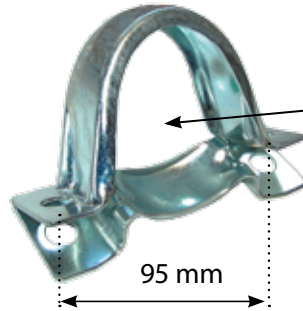

Shaft Drive Carrier IHC 4WD

**59973**



Bearing Shaft Drive Carrier  
IHC 4WD 32mm

**4971**

Gearbox Coupling IHC  
4WD **24 Splined**



**4972**

Gearbox Coupling IHC  
4WD **21 Splined**



**52049**

Stud to Suit 4971/4972  
Coupling IHC



**52865**



Bracket Support 4WD  
Shaft CX Case CX &  
McCormack CX

**52838**



Shaft Drive Carrier and  
Bearing CX Case CX &  
McCormack CX

**52794**

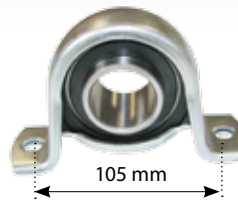

Shaft Drive Carrier Bearing  
Rubber Damper IH 585-985  
395-995 CX50- CX100 3210  
3220 4210 4220

**409823**



Pivot Ford 40's / Case Carraro  
Lower Also Case CX70/80/90  
5120-50 / 580 50HX

**52031**

Pivot Bush IHC  
885 1056 4WD  
Axle Centre



**52306**

Pivot Bearing Case  
MX100 - MX170 MX90C  
McCormick MC90 -  
MC130 MTX110 - 200  
XTX185 - XTX215  
Oe Ref: 247503A1



**52327**

Pivot Bearing Front  
Axle Case JXU105 115  
75 85 95 MX100 110  
120 135 Farmall 1154  
1054 95  
OE Ref: 87523063



## Decals



**52419** Decal Kit IHC 475 c/o 62 HP Stickers



**52420** Decal Kit IHC 574 c/o 68 HP Stickers



**52421** Decal Kit IHC 674 c/o 78 HP Stickers



**52418** Decal Kit IHC 374 574 674 Warning & Operation



**52301** Decal Kit Case International 5140 Old Type



**52302** Decal Kit International 784XL



**52297** Decal Kit Case 785XL



**52294** Decal Kit Case International 885XL



**52293** Decal Kit International 955XL



**52295** Decal Kit Case International 956XL

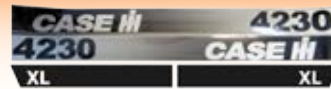

**52296** Decal Kit Case 4230XL



**52299** Decal Kit Case International 5130



**52298** Decal Kit Case IH 5130



**52300** Decal Kit Case International 5140

**53680** Decal 30kmph



**53681** Decal 40kmph



**53682** Decal 50kmph



**53683** Decal 60kmph



## Cab & Sheet Metal

### Grills

**51710**

Grill IHC 856 -1056XL  
Upper - New Type 955  
956 1046 1055



**52803**

Front Grill IHC 644 744 844  
745 845 946 1046 1246 995  
1055 856 956 1056



**3832**



Grill IHC 444  
474 574 674

**53270**



Seal Beam Rubber For 1140

**1140**



Seal Beam Ford  
Leyland David Brown  
4 1/4" 12v 40/40w  
Head Lamp - 3 Pin



**51711**

Grill Lower IHC 856  
-1056XL (New Type)  
\*\*955 955XL 956XL 1046  
1055\*\*



**4467**

Grill IHC 785 Top 238 248 278 384 385 484 485  
485XL 585XL 684 685 685XL 784 785 884 885  
885XL



**4463**

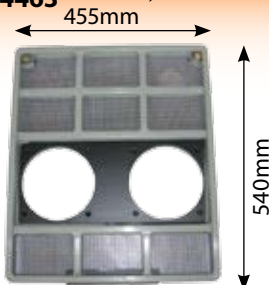

Grill IHC 785  
2WD Bottom

**4464**

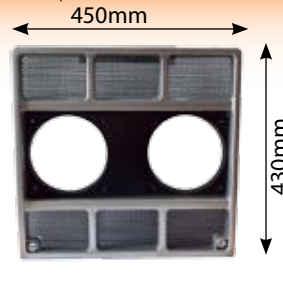

Grill IHC 785 4WD Bottom 238  
248 384 385 484 485 485XL 584  
585 585XL 685XL 785XL 885XL

**53271**



Seal Beam Rubber For 1598  
Case IH 784 884 485 485 XL  
585 585 XL 685 685 XL 785 785  
XL 885 885 XL

**1598**



Seal Beam IHC 5 3/4" 485  
485XL 585 585XL 685 685XL  
785 785XL 885



**52628**



Badge Front IH  
Grill = 4467

**52756**



Badge IHC Farmall Super A  
Super AV C Super C

**3149**

Grill Latch IHC



**52728**

Grill Knob Case



**43534**

Battery Cover IHC Case  
MX135 MX110 MX120  
MX135 MX100 MX150  
MX170  
OE Ref: 231049A5



**52183**



Grill Case McCormick CX

## Foot Steps

**59941**

Foot Step John Deere  
6600 6800 6900 - 3  
Step (3 Step) LH/RH



**52292**

Foot Step IHC 7110 7120 7130  
7140 7150 7210 7220 7230  
7250 8910 8920 8930 8940  
8950 Case Combine 2144  
2166 2188 2344 2366 2388  
OE Ref: 97050C3



**59980**

Foot Step John Deere  
Bolt On



**52435**

Foot Step Case MXC100  
MXC80 MXC90 MTX135  
OE Ref: 280340A1



## Mudguards

**52040**

Mudguard IHC - Pair 414  
B275 B250 B434

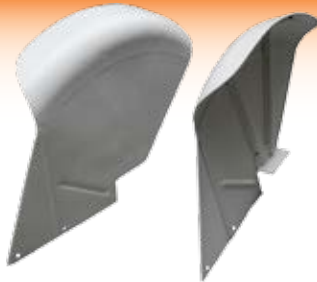

**52400**

Mudguard Set  
Case CX MX MXC  
OE Ref: 195949A4  
+ 195950A4



**52402**

Left Hand Mudguard Case  
955XL 956XL 1055XL 1056XL  
1255XL 1455XL  
OE Ref: 3234651R1



**52310**

Mudguard Case IH 3210 3220 3230  
4210 4220 4230 4240 743 743XL 844  
844XL 845XL 856XL LH 210mm Wide  
OE Ref: 3234659R1



**210mm Wide  
Narrow Version**

**52403**

Right Hand Mudguard  
OE Ref: 3234652R1  
AL118561

**52309**

Mudguard Case IH RH  
OE Ref: 3405809R1

**43584**

Mudguard Extension Case  
Puma, Steyr Left Hand  
OE Ref: 82038501



**43585**

Mudguard Extension Case  
Puma, Steyr Right Hand  
OE Ref: 82038500

**52629**

Mudguard Kit B450 - PAIR



## Side Panels

**52789**  
Side Panel RH Case IH 85 & 95 Series 485 495 585 595 685  
695 785 795 885 895 995

**52790**  
Side Panel LH



**52787**  
Side Panel RH Case IH 3210 3220 3230 4210 4220 4230 4240  
Also C50 C60 C70 C80 C90

**52788**  
Side Panel LH



## Foam

**52244**



Roof Lining Case XL Cab Grey

**52245**



Roof Lining Case XL Cab Brown

**52381**



Cab Foam Kit IHC MX100 MX110 MX120  
MX135 MX150 MX170

**52785 Kit** Cab Foam Kit Side Panel  
Case IH 90 1190 1290 1590 Sekura Cab

**52786 Kit** Cab Foam Kit Side Panel Case IH 94  
Series Sekura Cab

**52761**



Side Panel Trim LH Case IHC  
90 1190 1290 1590 1690 Sekura  
Explorer Cab \*\*Kit 52785 \*\*

**52760**



Side Panel Trim RH Case IHC  
1190 1290 1590 1690 Sekura  
Explorer Cab \*\*Kit 52785 \*\*

**52762**



Side Panel Trim RH Case IHC  
94 Sekura Explorer Cab \*\*Kit  
52786 \*\* 1194 1294 1394 1494  
1594 1694

**52763**

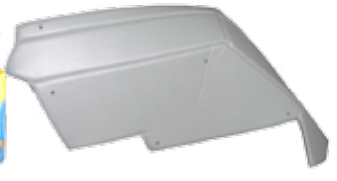

Side Panel Trim LH Case IHC  
94 Sekura Explorer Cab \*\*  
Kit 52786 \*\* 1194 1294 1394  
1494 1594 1694

## Foam Sheets

Part No	Thickness (")	Foam Sheet
<b>C1491</b>	1"	Grey 6 X 4 Foam Sheet
<b>C1496</b>	1/2"	Black 6 X 4 Foam Sheet
<b>C1499</b>	1/2"	Blue 6 X 4 Foam Sheet
<b>C1490</b>	1/2"	Grey 6 X 4 Foam Sheet

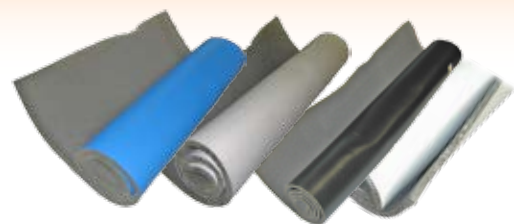

## Mudguards

### All Mudguard Flaps Sold As Pairs

#### Tractor Mudguard Flaps Sold as Pairs

Note: All measurements are +/- 15mm due to the nature of manufacturing process

2436	2WD	A: 320 mm, B: 960mm
2969		A: 350 mm, B: 1000mm
402947		A: 380 mm, B: 1140mm
2968		A: 400 mm, B: 1225mm
402948		A: 480 mm, B: 1160mm
2959		A: 540mm, B: 1320mm
2960		A: 600mm, B: 1340mm



62811



Mudguard Kit Universal  
4WD 400mm Flaps \*\*  
63136 is Adaptor Plate \*\*

63136



Conversion Plate Mudguard  
Mounting Bracket ZF Side  
Drive Case MF Carraro 709  
\*\* Suits 62811 Mounting  
Bracket Kit \*\*

62749



Mudguard Mounting  
Bracket 398 Pair

2993

Mudguard Kit Front 3060/3070 350mm 2WD



51719



Mudguard Spacer  
40mm

1488



Mudguard Trailer  
Tandem 8" x 68" -  
PAIR

1496

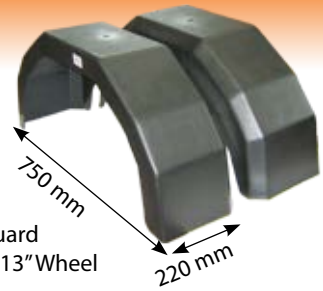

Mudguard  
Trailer 13"Wheel  
- PAIR

2991MP

Mudguard Mounting Plate



## Seats

**52657**

Seat Cushion IHC Old Type Red



**52658**

Seat Cushion IHC Old Type Black



**51534**

Seat Cushion & Back Rest Kit (Intl) 354 374 384 444 B250 B275 B414 BD276 BD434



**51806**

Seat Belt Automatic 2 Points



**2195**

Arm Rest Grammer Seat RH Landini John Deere Massey Ferguson \*\* LH Arm Rest is 2205 \*\*



## Badges

**52689**

Decal IHC B275 Round



**52765**

Tractor Badge IHC B250



**52766**

Tractor Badge IHC B275



## Cab Mountings

### 52026

Cab Mounting IHC 485 - 885 955 - 1455 (Front) 856 856 XL 885 XL 895 XL 955 XL 956 XL 995 XL 1055XL 1056XL 1255XL 1455XL 485XL 495XL 585XL



### 52036

Cab Mounting IHC Front 495 - 955 XL 3210 - 4240 & 5120 - 5150 & 5220 - 5250



### 43194

Cab Mounting Case Puma 115 - 230  
OE Ref: 87396965



## Shock Absorbers



### 43148

Shock Absorber Cab Suspension Case  
MXM120, MXM130, MXM135, MXM140,  
MXM150, MXM155, MXM165, MXM175,  
MXM180, MXM190  
OE Ref: 82029623



### 43200

Shock Absorber Cab Suspension Case  
SteyrCVT Series , CVT6130, CVT6145  
OE Ref: 84183931



### 43201

Shock Absorber Cab Suspension  
Case Maxxum Series -100 - 150  
MXU Series -100 - 135  
Steyr Profi Series  
OE Ref: 87301789



## Door Parts

### 4567

Door Handle Case 385, 485, 685, 785, 885, 585XL, 395, 495, 595, 695, 795, 895



### 404888

Door Latch Assembly Case JX100 U, JX1070 U, JX1080 U, JX1090 U, MXM120, MXM130, MXM140, MXM155



### 52472

Door Handle Case CVX195 CVX140 CVX150 CVX160 CVX170 CVX175 CVX130 CVX120 CVX1195 CVX1190 CVX1170 CVX1155 CVX1145 CVX1135 Steyr 9105 OE Ref: 134621042



### 59521

Door Case IH - LH suits XL Cab



### 42095

Door Handle MXU100, MXU110, MXU115, MXU125, MXU135 OE Ref: 82029168



### 4315

Door Lock Left Hand Inner Case IH CX MX OE Ref: 87639168



### 4316

Door Lock Right Hand Inner OE Ref: K303806

### 52491

Door Hinge Case IH 956XL 1056XL Upper Left Hand OE Ref: 3234093R1



### 52492

Door Hinge Case IH 956XL 1056XL Upper Right Hand OE Ref: 3234094R1

### 52829

Hinge Case MX Door Lower LH



### 52828

Hinge Case MX Door Upper LH



### 52493

Door Hinge Case IH 956XL 1056XL Lower Left Hand OE Ref: 3234074R1



### 52494

Door Hinge Case IH 956XL 1056XL Lower Right Hand OE Ref: 3234075R1



## Mirrors

### 53748

Mirror Remote Control Heated Electric  
 OE Ref: 4288898M91  
 Maxxum Series Puma Series



### 53155

Mirror Kit - Heated with Electrical  
 Adjustment Includes Cables and Mirror  
 Control



### 6480025

Mirror 237 x 180 Includes  
 16mm, 18mm & 20mm Clamps  
 OE Ref: 3902430M1

JX Series  
 JX100 U, JX1060, JX1070,  
 JX1070 U, JX1075, JX1080 U,  
 JX1085 U, JX1090 U, JX1095,  
 JX1095 U, JX1100 U

### 42946

Mirror Arm Left Hand With Cable  
 Case Puma 115-215 CVT \*\* Electric Mirror head is 53748 \*\*  
 OE Ref: 87346605



### 42947

Mirror Arm Right Hand With Cable Case Puma 115-215 CVT  
 OE Ref: 87497692

Extendable Mirror Arm Case  
 MX CX100 CX90 CX80 CX70 CX50 CX60  
 OE Ref: 297024A2



**52415** Left Hand OE REF: 297025A2

**52414** Right Hand OE REF: 297024A2

## Mirrors

**41102**  
Mirror Ford Rear View Case MXM  
OE Ref: 82014840

2042GL  
Mirror Glass



**409680**  
Mirror Arm RH Case MXM  
\* Mirror is 41102 \*  
OE Ref: 82014838



**409679**  
Mirror Arm LH Case MXM  
\* Mirror is 41102 \*  
OE Ref: 82014839



**41101**  
Mirror Rear View Case Maxxum Series, MX Series, MXU Series, Puma Series, SteyrCVT Series, McCormick MC Series  
OE Ref: 3787152M1



**42098**  
Mirror Arm RH Case Maxxum , MXU, Puma Series  
\* Mirror is 41101 \*  
\* Glass 41101GL \*  
OE Ref: 87314382 RH



**42099**  
Mirror Arm LH Case Maxxum , MXU, Puma Series  
\* Mirror is 41101 \*  
\* Glass 41101GL \*  
OE Ref: 87314381 LH



## Window Parts

**4515**  
Window Hinge Case  
584,684,784,884,  
International 484,784



**43243**  
Window Hinge Rear Kit  
Case JX MXM Series



**52027**  
Window Handle IHC  
XL CAB Rear



**52028**  
Window Handle Rubber IHC XL  
CAB Rear



**52342**  
Rivet Case CS80PRO - CS105PRO CVX140  
- CVX195 JX1070V - JX1095V JX1075C  
- JX1095C JX1070N - JX1095N JX70U -  
JX1100U JXU75 - JXU115MXM13  
OE Ref: 5162852

## Gas Struts

**Note:**

Check newton rating of existing gas strut before ordering a replacement. Using a gas strut with a lower or higher newton rating can result in damage or glass breakage.

**53184**



Application	Models		
Rear window	3230 4210, 4220, 4230, 4240 844 955, 1055, 1255, 1455 856, 956, 1056 485, 685, 785, 885		
Force (N)	Length (mm)	Ram (mm)	OE Ref
180	550	235	3234163R1

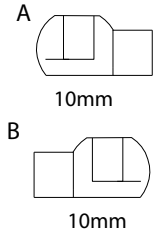

**52092**



Application	Models				
Rear window	CX100, CX50, CX60, CX70, CX80, CX90 MX100, MX100 C, MX110, MX120, MX135, MX150, MX170, MX180, MX200, MX220, MX240, MX80 C, MX90 C				
Application	Models	Force (N)	Length (mm)	Ram (mm)	OE Ref
		200	485	205	189447A2

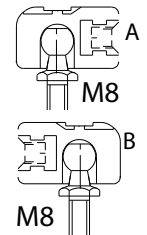

**52091**



Application	Models		
Door	CX100, CX50, CX60, CX70, CX80, CX90 5120, 5130, 5140, 5150 MX100, MX100 C, MX110, MX120, MX135, MX150, MX170, MX80 C, MX90 C		
Force (N)	Length (mm)	Ram (mm)	OE Ref
350	250	77	1977416C1

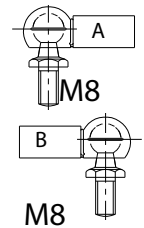

**43471**



Application	Models		
Door	CASE CS CVX		
Force (N)	Length (mm)	Ram (mm)	OE Ref
500	205	65	134621099

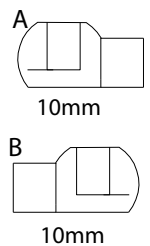

**6353**



Application	Models		
Rear window	CX100, CX50, CX60, CX70, CX80, CX90 MX100, MX100 C, MX110, MX120, MX135, MX150, MX170, MX180, MX200, MX220, MX240, MX80 C, MX90 C		
Force (N)	Length (mm)	Ram (mm)	OE Ref
200	485	205	3548042M91

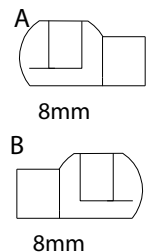

**43533**



Application	Models		
Rear Window	SteyrCVT Series CVT6170, CVT6185, CVT6205, CVT6215, CVT6230		
Force (N)	Length (mm)	Ram (mm)	OE Ref
			82022486

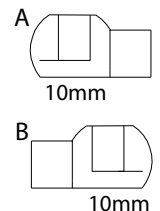

## Gas Struts

**Note:**

Check newton rating of existing gas strut before ordering a replacement. Using a gas strut with a lower or higher newton rating can result in damage or glass breakage.



**59371**

Application	Models
Rear window	6000 Series 6010 Series 6020 Series 6030 Series

Force (N)	Length (mm)	Ram (mm)	OE Ref
130	500	195	AL114803

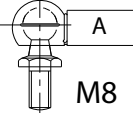

A

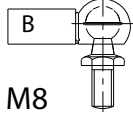

B

M8



**2834**

Application	Models
Rear window	2610, 2910, 3610, 3910, 4110, 4610, 5110, 5610, 6410, 6610, 7410, 7610, 7710 3230, 3430, 3930, 4630, 4830, 5030

Force (N)	Length (mm)	Ram (mm)	OE Ref
200	500	210	83932024

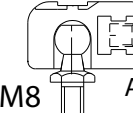

A

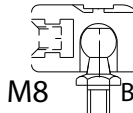

B

M8



**407119**

Application	Models
Rear window	MXM120, MXM130, MXM135, MXM140, MXM150, MXM155, MXM165, MXM175, MXM180, MXM190

Force (N)	Length (mm)	Ram (mm)	OE Ref
220	585	255	81865239

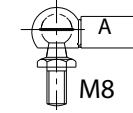

A

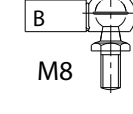

B

M8



**43533**

Application	Models
Door	Case SteyrCVT Series CVT6170, CVT6185, CVT6205, CVT6215, CVT6230

Force (N)	Length (mm)	Ram (mm)	OE Ref
			87374182

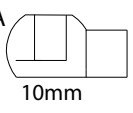

A

10mm

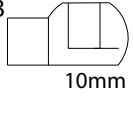

B

10mm



**41766**

Application	Models
Bonnet	MXM120, MXM130, MXM140, MXM155

Force (N)	Length (mm)	Ram (mm)	OE Ref
500	900	400	82019392

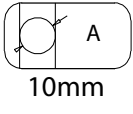

A

10mm

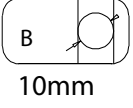

B

10mm

**000000**

Application	Models
Bonnet	

Force (N)	Length (mm)	Ram (mm)	OE Ref

## Glass

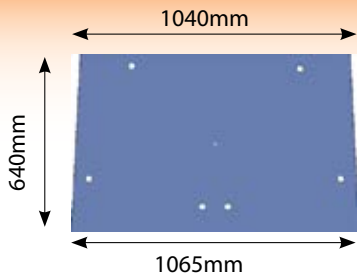

**2223**  
Glass Ford AP IHC Super Deluxe Top Rear  
Glass 6 Hole Glass 584 684 784 884 385  
485 685 785 885 585 484  
OE Ref: 3125412R1

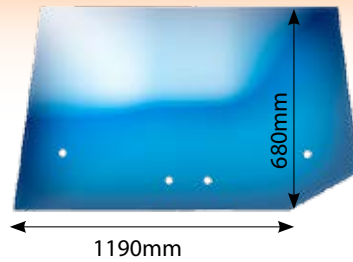

**4230**  
Glass Case 3230 4210 4220 4230 4240  
Upper Rear LP Series Cab - 6 Hole

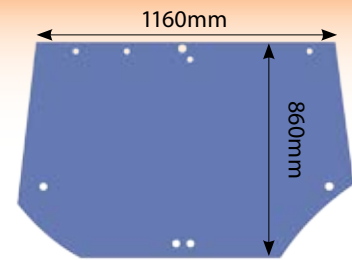

**52093**  
Glass Case MX Series Rear Window -  
9 Holes

## 1194-1694

**4597**  
Glass Case Lower Door LH Case/IH  
1190 - 1694, OE Ref: K303703

**4598**  
Glass Case Door Lower RH Case/IH  
1190 - 1694, OE Ref: K303702

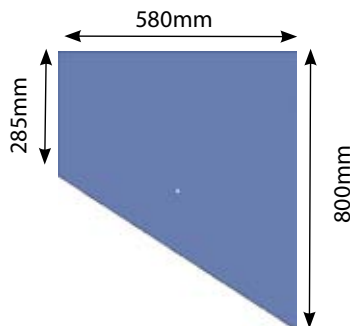

**D7025**  
Glass IHC Deluxe 1390 Top RH Door  
OE Ref: K303700

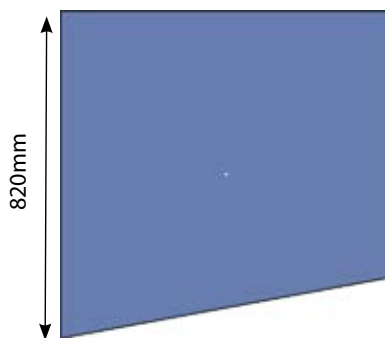

**2380**  
Glass Case 1394 Rear Upper 8 Hole  
Case IHC 1190 - 1694 OE Ref: K312000

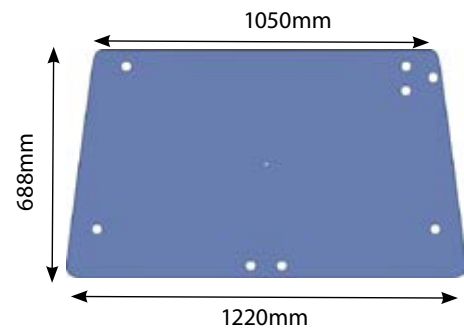

**52094**  
Glass Case CX MX McCORMICK Door  
Left Hand - 6 Holes

**52095**  
Glass Case CX MX McCormick Door  
Right Hand

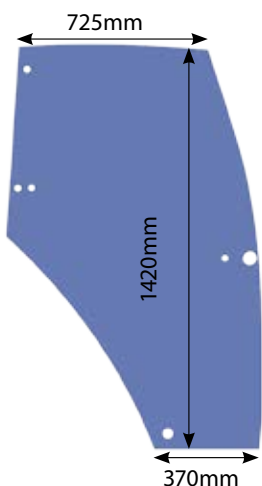

**52376**  
Glass Case CS 94 - 150 Door Left Hand

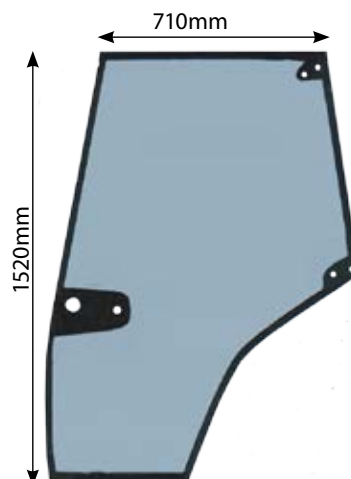

**4109**  
Glass Case 4200 Door Left Hand Cab 3210 -  
4210 3220 - 4220 3230 - 4230 6 Hole 4240

**4229**  
Glass Case 4200 Door Right Hand LP  
Cab



## Glass

### XL

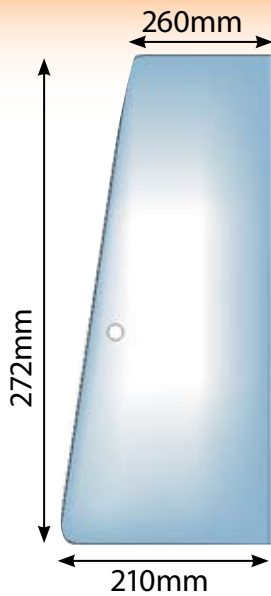

**4658**  
Glass IHC XL Front Section Door

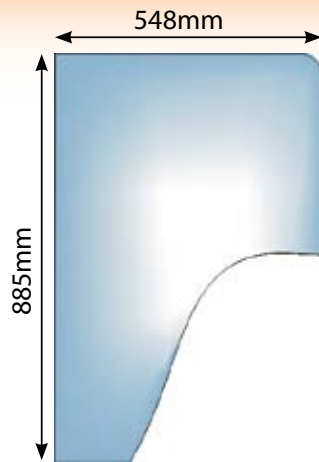

**2230**  
Glass IHC XL Door LH & RH Rear Section

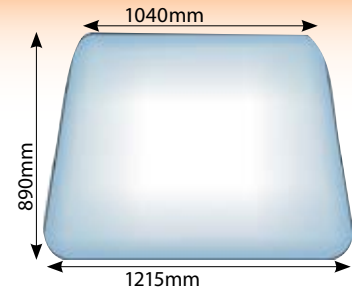

**D7010**  
Glass IHC XL Windscreen

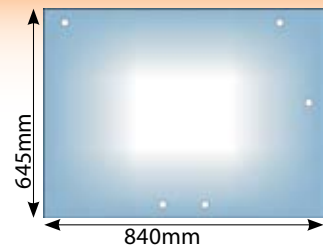

**2232**  
Glass IHC XL Upper Rear



**4585** Glass IHC XL Lower Rear Window

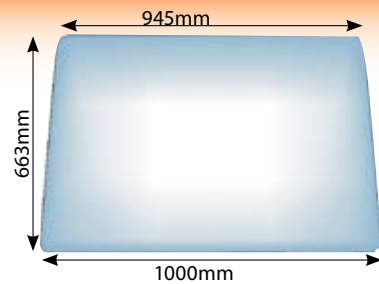

**4578** Glass IHC 84 Rear Window

### JX

**42887**  
Glass Case JX Series Rear - 8 Holes

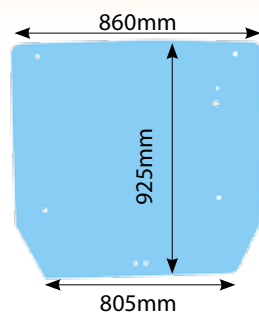

**52271**  
Glass Case JX55 JX65 JX75 JX85 JX95 Side Left Hand Corner  
OE Ref: 5089600

**52272**  
Glass Case JX55 JX65 JX75 JX85 JX95 Side Right Hand Corner  
OE Ref: 5089556

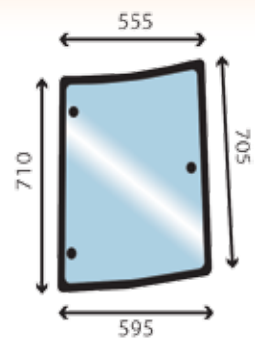

## Maxxum

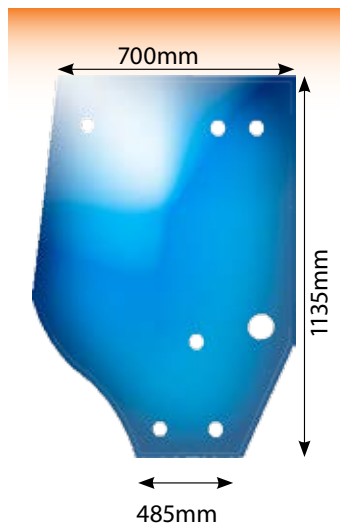
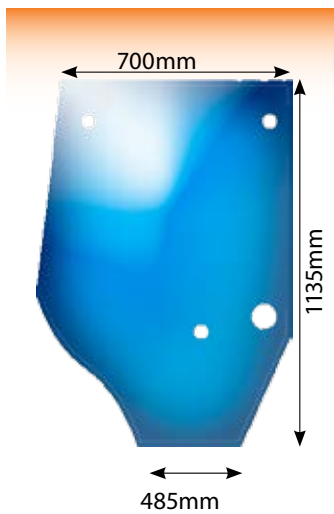
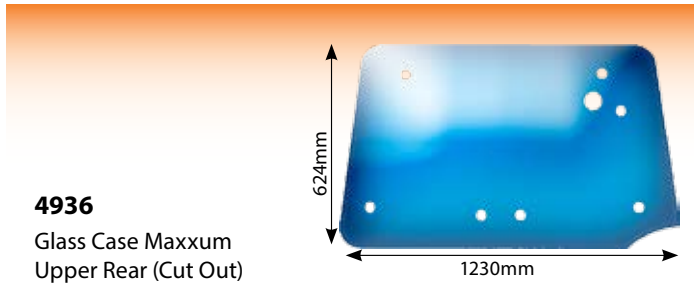

**4974**  
Glass Case Maxxum  
Door Left Hand **4 Hole**

**4938**  
Glass Case Maxxum Door  
Right Hand **7 Hole**

## MXU

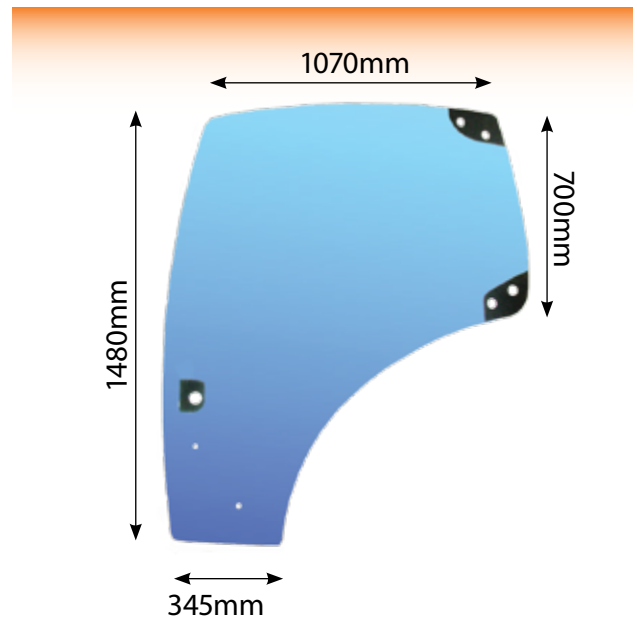
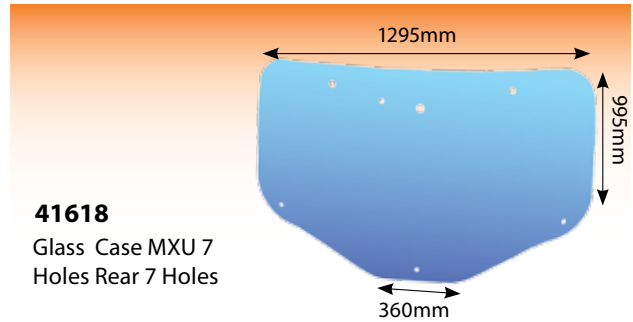

## MXM

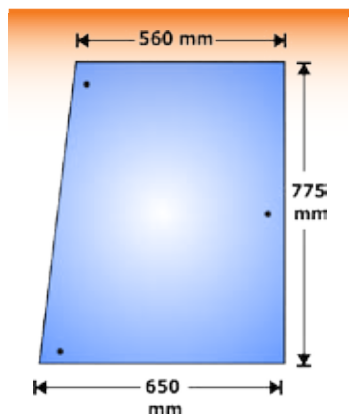

**404732**  
Glass Overwing Left Hand  
Curved  
[OE Ref: 82009813](#)

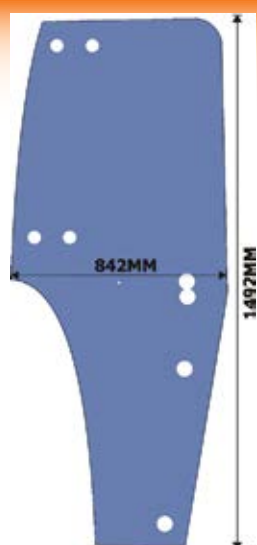

**41077**  
Glass Door RH - 7 Hole  
MXM120-MXM190 JXU  
[OE Ref: 82019225](#)

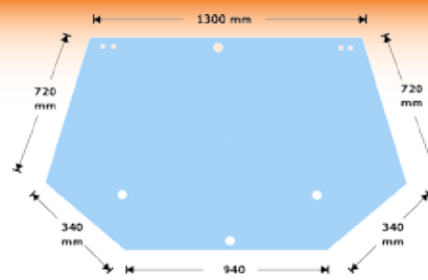

**404666**  
Glass Rear 9 Hole  
MXM Series [OE](#)  
[Ref: 82005316](#)

**52453**  
Right Hand Glass Lower Front Case  
MXM120 140 155 175 190 M100  
M115 M135 M160 8160 8260 8360  
8560  
[OE Ref: 82001924](#)

**52454**  
Left Hand Glass Lower Front  
[OE Ref: 82001923](#)

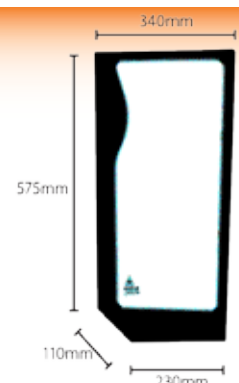



## Rubber Strips and Trims

### ALL RUBBER SOLD PER METRE

**3097**



Beaded Strip 500 - Per Mtr ( 1" or 25mm ) Beaded Strip 500's (Per Mtr)

**1773**



Weather Strip Beaded ( 22mm ) 4.8 mm Glass

**1774**



Filler Strip for 1773 3097 - Sold in Mtrs.

**1888**



S Section Rubber - min sale 25mtr 50 mtr per roll

**3984**



Vinyl Edge Trim Sold per Metre For From 0.7 - 2.5mm Glass / Panel

**1285**



Draught Excluder Rubber - sold by the metre for 1 to 3 mm 50mtr Per Roll

**51553**



Filler Strip 20D Bubble Each Side 10 Mtr Roll Dexta & Major Bonnet

**2548**



Weather Strip 300 - Per Metre

**1407**



Rubber Section 6mm Metre for 3mm to 6mm

**51554**



Rubber 35 Dash Instrument Panel

**51555**



Filler Strip c/o Lip - 10 Mtr Roll

**1427**



Weather Strip Tool

**51227**



Glass Bonding Kit

**51382**



Rubber Section - Per Mtr

**59723**



Seal - John Deere 20 Series Front Windscreen

**53017**



Body Filler Isocon P38 Lightweight 250ml

**53018**



Fibre Glass Repair Paste Isocon P40 250ml

**53019**



Fibre Glass Repair Kit Fastglas

## Wiper Motors

**2494**

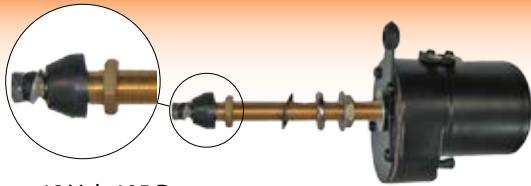

Wiper Motor 12 Volt 105 Degrees  
Small Tapere

**2493**



Wiper Motor 12 Volt 85 Degrees  
Small Tapered

**41656**

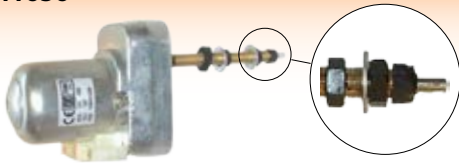

Wiper Motor 12 Volt 120  
Straight Single Spin  
Shaft Length 99mm

**51045**

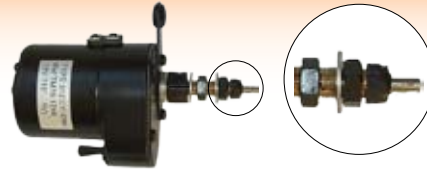

Wiper Motor 12 Volt 110 Short Stem  
Straight Shaft Length 46mm  
Arm ref is 4296

**2491**

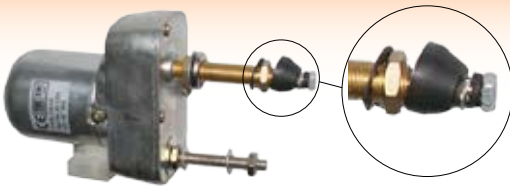

Wiper Motor 12 Volt 80 Small Tapered Shaft  
Shaft Length 58mm - Check Type of Cab

**2492**

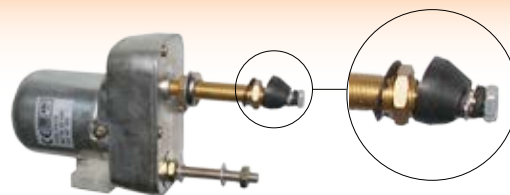

Wiper Motor 12 Volt 110 Small Tapered Shaft  
Shaft Length 58mm

**51025**

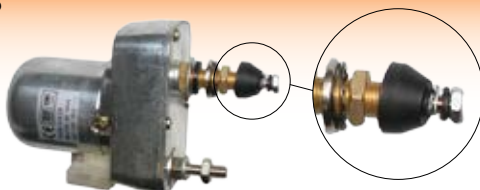

Wiper Motor Case 12V 135 Small Tapered Shaft  
Shaft Length 34mm

**51026**

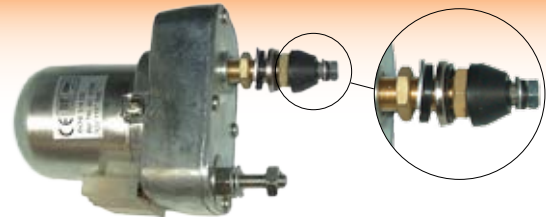

Wiper Motor Case 12V 115 Small Tapered Shaft  
Shaft Length 34mm

**51260**



Wiper Motor 12 Volt 90  
Small Tapered Shaft  
Wiper Motor With Cover &  
Switch - Shaft 48mm

**51006**

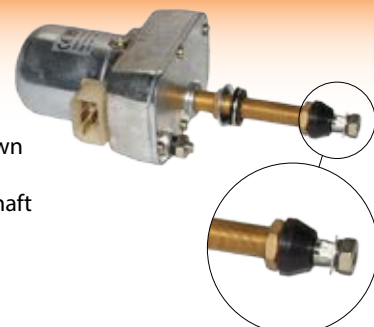

Wiper Motor David Brown  
12V 95  
Large Tapered Shaft - Shaft  
Length 80mm

## Wiper Motors

**1008**

**Kit = 4169**



Wiper Motor 12 Volt 110 Degrees Small Tapered c/w Switch - Shaft Length 58mm

**3859**

**Kit = 4195**



Wiper Motor 12 Volt 90° Small Tapered Shaft c/w Switch Used in kit 4195 (Shaft length 58mm)

**3860**



Wiper Motor 24 Volt 90° Small Tapered Shaft c/w Switch - Shaft length 58mm

**4169**



Wiper Motor Kit 12 Volt 110° c/w Arm & Blade Shaft Length 58mm

**4195**

**Motor = 3859**



Wiper Motor Kit 12 Volt 90° c/w Arm & Blade Shaft Length 58mm

**6671**



Wiper Motor 300 12V 115° Small Tapered Shaft (Shaft length 78mm)

**6645**



Wiper Motor 390 12V 105° Large Tapered Shaft Shaft length 33mm

**63240**



Wiper Motor Front 54s 42s 43s

**1563**



Wiper Motor Ford Super Q TW5 TW35 10

**59283**



Wiper Motor John Deere 6000

**51027**



Wiper Motor John Deere SG2 12V 90°

**51061**

Arm = 2207  
Blade = 1619



Wiper Motor 5400 6100 6200 6400 7400 8100  
Also Fits 8200 - For Rear Window

**51059**

Arm = 2207  
Blade = 1619















Wiper Motor 390 398 105° Shaft Length 48mm

## Wiper Arms

Photo	Part No	Motor Type	Description	Length	
				Inches	mm
	4296	Straight Shaft	Wiper Arm	18"	457.2
	2014	Straight Shaft	Parallel Arm	18"	457.2
	2207	Tapered Shaft	Wiper Arm		
	1897	Tapered Shaft	Parallel Arm blade=1619	19½"	500
	51497		Wiper Arm	15½"	400
	51008		Wiper Arm MF 600's	19½"	500
	2870		Wiper Arm Ford Super Q & Q Cab blade=2837	17"	431.8
	4894		Wiper Arm Large Hole	15½"	400
	780036		Wiper Arm Renault TS-TX	19½"	500

## Wiper Blades

Photo	Part No	Description	Length	
			Inches	mm
	2206	New 1008 Motor		400
	2246	Wiper Blade	17½"	450
	4685	Wiper Blade	24"	609.6
	1619	Suit 1897 Wiper Arm	20"	508
	6753	SUIT 600/3000'S		600
	61941	42/43/61/62/81/82's ALSO 5400 6400 7400 Case Ford DB Fiat Deutz JD Leyland	20"	508
	2837	Ford Q & Super Q Cab John Deere 50's SG2 Cab Wiper Arm =2870		500
	404895	Ford 40 TS TM M		550
	51009	Case XL		650
	62039	Wiper Blade Front J.Deere 6000/10/20 Front and Rear for 50HX	23½"	600
	59803	Wiper Blade Rear John Deere 6000/10/20		
	780048	Wiper Blade Renault TS/TX		

## Electrical Parts

### Starters

**51412**

Starter Cummins 12V - LH FIT



**52111**

Starter Case IHC Old - B414



**52519**

Starter IHC 433 533 633 733 833 3.1KW  
11 Teeth [OE Ref: 138207A1](#)

**MAHLE**  
Letrika



**52637**

Starter IHC Original Lever Type  
B275 (1958 - 1964) B414



**4979**

Starter IHC 684 784 885 LH FIT  
\*\*Iskra Version is 52781\*\*  
Case 995XL

**Lucas-TVS**  
Auto Electrical Equipment



**52781**

Starter Iskra 3kw IHC 684 784 885 LH FIT  
\*\*4979 Is Lucas Version \*\*

**MAHLE**  
Letrika



**51556**

Starter Case 956 1056 LH Fit



**1940**

Starter 188 Phaser 4 Cylinder - Left Hand Fit CX100, CX70, CX80, CX90

**Lucas-TVS**  
Auto Electrical Equipment



**62071**

Starter High Speed 4.2kw LH Fit Case CX100, CX70, CX80, CX90



## Electrical Parts

### Starters

**52480** Starter Gear Reduction  
Case CS CX CVX  
OE Ref: 87751000

**MAHLE**  
Letrika



**5146**  
Starter 12 Volt 3.0 kW - RH Fit



**42892**  
Starter 12 Volt 4.2 kW - RH Fit Case  
MXU100, MXU110, MXU115, MXU125,  
MXU135  
Iskra



**43299**  
Starter 12 Volt - 4.2kw RH Fit - 10 Teeth  
JX105 U, JX1070 U, JX1080 U, JX1090 U, JX1100 U



**7093**  
Starter 12 Volt 3.0KW-LH Fit Case JX&JXU Series



**59534**  
Starter Gear Reduction LH Fit , Case JX Series



**52113**  
Starter Case Maxxum/MX series RH 12 V / 3,1 kW  
ISKRA OE Ref: 114799A1



**41587**  
Starter 4.2 kW Case MXM120, MXM130, MXM140,  
MXM150, MXM155, MXM165, MXM175, MXM180,  
MXM190



**41587R**  
Starter 4.2 kW Case MXM120, MXM130, MXM140,  
MXM150, MXM155, MXM165, MXM175, MXM180,  
MXM190



## Electrical Parts Alternators

**52114**



Alternator IHC 856 956 1056 & Fendt

**6760P**



Alternator 300 12V 70amp With Correct Pulley Also Super Q 7610



**MAHLE**  
Letrika

**52479**

Alternator 65 AMP Case 238 248 258 4220 B95  
OE Ref: K302424

**52148**



Alternator IHC 5210-5150 14v 95amp Also fits Case MX110-170 McCormick MC90 115 125 MTX 110 155 175

**52147**



**MAHLE**  
Letrika

Alternator IHC 4210-4240 14v 70amp Also fits CS50-90, CX50-100



**52441**

Alternator Case Farmall 105A 105U 115A 55C 65A 65C 75A 75C 85A 95A 95U JX70 JX60 JX95 JX80 JX80 OE Ref: 87311822



**52455**

Alternator Case MX180 200 210 220 230 240 255 270 285 STX 275 325 375 425 440 450 500 Fiat G170 G190 G210 G240 150 Amp OE Ref: 125849A1



**41698**

Alternator Case MXM120 MXM125, MXM130, MXM135, MXM140, MXM150, MXM155, MXM165 OE Ref: 47744887



**52482**

Alternator Case CS CVX 14v 120amp  
OE Ref: 3655838M91

**MAHLE**  
Letrika



**52483**

Alternator Case Puma 165 80 195 210 215 240  
OE Ref: 87573243

**MAHLE**  
Letrika



## Electrical Parts



**3992**  
Heater Plug IHC



**53418**  
Heater Plug Steyr 80 Series  
OE Ref: 31100090023



**2666108**  
Heater Plug with  
Push On Connection  
94/4200/84/85/95  
OE Ref: 81806046

**3979**



Solenoid Switch IHC 495 - 995 Also fits 3320 - 4240 -  
replaces original Luc

**3960**



Solenoid David Brown 1190 1490 IHC 276 434 Also Fits  
Massey Ferguson 3/5/600 & Landini

**61749**



Starter Brush IH MX,  
Maxxum (wet clutch)

**52616**



Heater Plug Resistor IHC 414 354 374  
444 B275 B414 BD276 BD343 BD434

**52826**



Heater Plug Resistor Element IHC



**52115**  
Bendix Drive for 4979  
(LRS240)



**3437**  
Temperature Sender CASE  
IH 4210/20/30/40 485, XL/5  
84/685/695,XL/784/785,XL  
/885,XL/895, Thread 1/2" x  
14 NPFT



**52230**  
Temperature Sender Case IH  
AVJ55 AVJ60 AVJ70 JX106OC  
JX80 JX80U JX85 JX90 JX90U  
JX95



**1877721**  
Oil Pressure Switch 200 500  
600 3000 4200 6100 8100  
8200 Case Maxxum CX MX -  
Light OE Ref: 1877721M92

## Electrical Parts

**52204**

Safety Start Switch Case  
McCormick



**51707**

Lift Switch Case Maxxum  
5120 - 5150



**53620**

Switch Case 3210 3220 3230 4210 4220 4230 4240 743 743XL  
844 844XL 745S 745XL 845 845XL 1055 1055XL 1255 1255XL  
1455 1455XL 955 955XL



**52348**

Beacon Switch Case C50 60 70 80 90 CX60 70 80 90 CX100  
Magnum 7130 7230 7240 7250 7110 7120 7140 7210 7220  
7250 Maxxum 5140 5130  
OE Ref: 245909C1



**52385**

Sensor Forward/Reverse Case  
McCormick



**52388**

Switch Flywheel Sensor Case  
McCormick



**52386**

Speed Sensor Harness Case  
McCormick



**36052**

Ammeter IHC 414



**36056**

Gauge IHC 414 Oil Pressure 434/  
B414/275/354/444



**36055**

Gauge IHC 414 Temperature



**530133**

Rev Counter  
International 414



**4556**

Relay 12v Normally  
Open 40A



**51599**

Relay 12v Head  
Lamp Main Beam  
& Dim CX MX  
Maxxum



**52773**

Wiring Loom IHC B250 414



**2902**

Rev Counter Cable IHC XL 42  
1660mm

**3087**

Rev Counter Cable IHC 784 885  
L Cab 1450mm



## Electrical Parts

### Ignition Switches



**52050**  
Ignition Switch IHC 42 \*\* 33 01 32 on Switch Digital Dash, Electric Shuttle \*\* 51181K is K \*\* 51181 is without electric shuttle \*\*



**51181**  
Ignition Switch IHC JCB \*\* 33 02 62 on switch C55 C55A C64 C64A C70A CS48 CS48 CS52 CS58 CS63 CS68 CS75 (Not for digital dash) Fendt



**51181K**  
Ignition Switch Key IHC JCB New Type \*\* Waterproof Key \*\*



**53236**  
Cover Key Hole Water Proof Ignition Switch



**53237**  
Cover Terminal Water Proof Ignition Switch

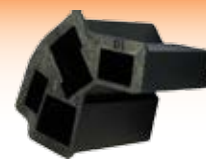

**53238**  
Cover Terminal Water Proof Ignition Switch



**53235**  
Cover Bottom Water Proof Ignition Switch



**1294**  
Ignition Switch Dynamo Type - 14mm Case B250, B275, B414, B434  
OE Ref: 2846124 35630

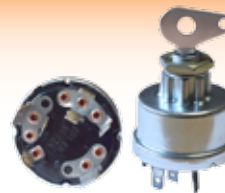

**1323**  
Ignition Switch Heat Start Alternator Type 14 Case 32 Series, 4200 Series, 74 Series, 84 Series

**52098**  
Ignition Switch Case CX70 CX80 CX90 John Deere 2440 2640 2940 2150 2255  
OE Ref: 282775A1



**52324**  
Key Ignition Switch Pair Case 8910 8920 8930 8940 8950 C100 C50 C60 C70 C80 C90 CX100 CX50 CX60 CX70 CX80 CX90 MX100 MX110 MX120 MX135 OE Ref: 1964831C2



**52345**  
Ignition Key Case JXU 75 85 95 105 115 Maxxum 100 110 115 120 125 130 135 140 145 150 MXM180 130 135 140 150 155 165 175 120 190 OE Ref: 82030144



## Electrical Parts

### Isolation Switches

#### 3875E

Cut Off Isolation Switch Amp Heavy Duty  
Max Peak Load 12/24V 2500A for 5  
Seconds Max Continuous Load 12/24V  
250A OE Ref: 1939387



#### 3875

H/D Isolation Switch 24V 2500 amp  
(Complete with chain)



#### 51896



Key For Cut Off  
Isolation Switch 24V  
2500 Amp HD

Suits 3875

#### 2923

Cut Off Isolation Switch -  
Heavy Duty



#### 2303

Lucas cut off switch



### Warning Lights

#### 1839



Dash Mounted  
Lamp Warning Amber

#### 3101



Dash Mounted  
Lamp Warning Green

#### 1844



Dash Mounted  
Lamp Warning Blue

#### 1259



Red Warning Lamp  
Dash Mounted

#### 2613



Warning  
12v 13mm Hole

#### 1314



Red Warning Light  
12v (13mm Hole)

#### 2616



Light Warning Green  
12v-13mm Hole

#### 2614



Light Blue Warning 12v  
13mm Hole

### Switches



#### 52279

Switch Hoisting Up Case CS100 CS110 CS120 CS150 CS48 CS52  
CS58 CS63 CS68 CS75 CS78 CS86 CS94 CS48 Steyr 9100M 9105  
9115 9125 9145



#### 52280

Switch Lift & Lower Case Maxxum Series

## Fan Cab Blowers



### 52754

Fan Cab Blower 3230, 4210, 4220, 4230, 4240, 1255 XL, 1455 XL, 1056 XL, 956 XL, 495, 595 XL, 695 XL, 795 XL, 895 XL, 995 XL, 7110, 7120, 7130, 7140, 7150, 7210, 7230, 7240, 7250, 5120, 5130, 5140, 5150, 5220, 5230, 5240, 5250



### 58690

Fan Cab Blower John Deere 40 50 10 SG2 Cab 11 Series Combine SG2 Cab

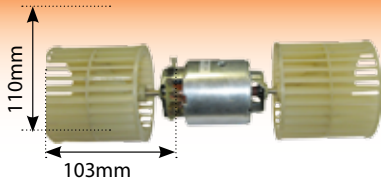

### 62780

Fan Cab Blower 3000 6100 5400 6200 8100 Also fits 8200



### 62777

Fan Cab Blower 300



### 42111

Fan Cab Blower CX100, CX80, CX90 JX55, JX60, JX65, JX70, JX75, JX80, JX85, JX90, JX95 MX110, MX120, MX135, MX150, MX170 MXM120, MXM130, MXM140, MXM155, MXM175, MXM190 JX105 U, JX115 U, JX75 U, JX85 U



### 42214

Blower Resistor Case CX, JX, MX, MXM  
Suits 42111



### 42215

Motor for 42111 TM Blower  
Suits 42111



### 42113

Fan Cab Blower MXU100, MXU110, MXU115, MXU125, MXU130, MXU135 Puma 165, Puma 180, Puma 195, Puma 21



### 52753

Fan Cab Blower MX180, MX200, MX220, MX230, MX240, MX255, MX270, MX285 STX275, STX280, STX325, STX330, STX375, STX425, STX440, STX450, STX480, STX500, STX530



### 53132

Ducting 10 Metre Roll Air Conditioning

## Head Lamps

### 1732

Head Lamp Right Hand Case  
B250, B275, B414  
International 444

### 1733

Head Lamp Left Hand



### 51700

Head Lamp IHC 4445 4455  
383 423 523 654 724 824  
1046 1246 946 553



### 51701

Head Lamp (163mm x  
104mm) 433, 633, 733, 833  
743 XL 844 XL 1255 XL, 1455  
XL 1056 XL, 856 XL, 856, 956  
XL 533



### 52443

Head Lamp Case CS  
Series Steyr 9100 Series  
CV Series **OE Ref:**  
134672150



### 52255

Head Lamp Case LH 5120 5130 5140  
5150 2150 3210 3220 3230 440 540  
640 740 840 940 4210 4220 4230  
4240 743 743XL 844 844S 844XL  
135mm Wide x 122mm High



### 52256

Head Lamp Case Right Hand

### 52257

Head Lamp c/o Work Lamp Case LH  
MX100

**OE Ref:** 178318A1



### 52258

Head Lamp c/o Work Lamp Case RH  
MX100MX100 MX120 MX135 MX150  
MX170

**OE Ref:** 178317A1

## Front Indicator Lamps



### 52312

Front Indicator Lamp Case 32 Series, 33 Series,  
42000 Series, 44 Series 89mm High **OE Ref:**  
3226120R1+3226119R1



### 51527DE

Front Indicator Lamp Case 42 Series



### 2089

Front Indicator Parking Lamp  
33/40/45/84/85/44 Series  
84mm Long 84mm High 51mm Deep

### 42128

Front Indicator Lamp RH MXM 35 Series TL  
TMTSFiats F Series



### 42127

Front Indicator Lamp Left Hand

### 52102

Front Indicator Case CX70/80/90 LH 128mm  
Length 80mm High 57mm Deep



### 59799

Indicator Lamp Less Bulbs 77mm  
Diameter 40mm Deep  
IHC D215 D219 D322 D326 D432  
D439 D440



## Rear Lamps & Combination Lamps

### 52822

Rear Lamp Case 3210 3220 3230 4210  
4220 4230 4240 743XL 844XL 856  
856XL \*\* 52757 includes number  
plate lamp \*\*



### 3099

Lamp 300 Rear Combination  
Red & Amber David Brown 90  
94 76mm High 184mm Wide  
65mm Deep



### 4207

Signal Lamp Double Sided 80mm  
High 120mm Wide 80mm Deep



### 2529

Lens for 4207 Front Lamp  
80mm High 120mm Wide



### 680090

Rear Lamp Case 33  
Series, 43 Series, 44  
Series, 46 Series  
89mm High 88mm  
Wide 54mm Deep



### 52096

Rear Lamp Case CX70  
80 90 RH C/O Wire &  
Conne 186mm Wide  
66mm High 65mm  
Deep



### 62788

Rear Combination Lamp Case CX50-  
CX100, MX100-MX170



### 52445

Indicator Lamp Case CS  
Series CVX Series Steyr 9000  
Series CVT Series RH [OE Ref: 134676001](#)



### 52446

Indicator Lamp LH  
[OE Ref: 134676002](#)

### 52444

Lens [OE Ref: 134776014](#)

### 4200

Rear Lamp - PAIR JX100, JX1070U, JX1080U, JX1090U,  
JX1100, JX70U, JX80U, JX90U  
Lens = 2390 [OE Ref: D3NN13N329E + D3NN13](#)

### 2390

Lens for 4200 Rear Lamp 171.5 x 73 x 35.8 mm  
[OE Ref: D3NN13208A](#)



### 1716

Lens = 2416

Rear Combination Lamp 12v Flat  
PAIR 185mm x 67mm x 50mm



### 1759

Lens = 2416

Rear Combination Lamp 12v  
Tapered PAIR 185mm Length x  
67mm High x 68mm Deep

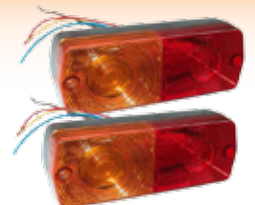

## Marker Lamps

**51391**

Butler Rear Stop Lamp  
12V B250, B275, B414



**52307**

Front Marker Lamp IHC  
323 383 423 453



**52308**

Rear Lamp IHC 323 383  
423 453



**1715**



Front Marker Lamp 12v Flat PAIR  
185mm Length x 67mm High x 50mm Deep

**1717**



Front Marker Lamp 12v Tapered 185mm  
Length x 67mm High x 68mm Deep

**53742**

Front Marker Lamp RH Case CS, CVX, Maxxum,  
MXU, Puma, SteyrCVT, Profi, 9000 Series, 9100  
Series, M Series, 8000 Series [OE Ref: 87313173](#)

**53743**

Front Marker Lamp LH Case CS, CVX, Maxxum,  
MXU, Puma, SteyrCVT, Profi, 9000 Series, 9100  
Series, M Series, 8000 Series [OE Ref: 87378477](#)



**53744**

Lens Front Marker LH/RH Case CS, CVX, Maxxum,  
MXU, Puma, SteyrCVT, Kompakt, Profi, 9000 Series,  
9100 Series, M Series, 8000 Series  
[OE Ref: 87304539](#)





## Work Lamps

**2324**



Work Lamp Cab H3 Single Mounted 6"x3.5" (24 in a box) 154mm Wide x 84mm High

**2356**



Work Lamp Small Rubber Body 55 Watt bulb 125mm Diameter 76mm Deep

**51389**



Work Lamp John Deere/ Case IHC 142mm x 142mm x 105mm Deep



**51351**

Lamp IHC c/w Bulb - Rubber 132mm x 80mm Deep



**52442**

Front Worklamp Case CS Series Steyr 9105 9105 9115 9125 9145  
OE Ref: 134672400



**43503**

Work Lamp Front Case Puma, MXU, Maxxum \* Bulb is 41841 \*  
OE Ref: 82031075



**43461**

Work Lamp Front LH Case Maxxum  
OE Ref: 84138309



**43462**

Work Lamp Front RH Case Maxxum  
OE Ref: 84138310

## Bulbs



**1412**

12V 21W Bulb (Indicator)

**1413**

12V 5/21W Bulb (Stop & Tail)

**Date:**..... **No. of Pages:**.....  
**Name of the Rep:**..... **A/C Number:**.....  
**From:**..... **e-mail:**.....  
**Phone No.:**..... **Fax No.:**.....

Please quote for the following parts - Quotation Number :   
 I wish to confirm the following order on Quotation Number:   
 Please supply the following parts:

Please photocopy this page

Please do not remove this page

	Qty	Part No.	Description	Unit Price
1.				
2.				
3.				
4.				
5.				
6.				
7.				
8.				
9.				
10.				
11.				
12.				
13.				
14.				
15.				
16.				
17.				
18.				
19.				
20.				
21.				
22.				
23.				
24.				

**Comments:**  
 \_\_\_\_\_  
 \_\_\_\_\_  
**Customer Signature:** \_\_\_\_\_ **Rep's Signature:** \_\_\_\_\_

**Tel No: + 353 44 934 1638**

**e-mail: info@qtponline.com, www.qtponline.com**

**Page**  **of**

## Beacons

<p><b>51320</b></p>  <p>Beacon 12V Magnetic c/w Bulb Lucas Type</p>	<p><b>51332</b></p>  <p>Beacon 12-80v Mini Xenon</p>	<p><b>59624</b></p>  <p>Beacon John Deere 12v Flexi Stem Small</p>	<p><b>51321</b></p>  <p>Beacon 12v Flexi Stem Lucas Type</p>	<p><b>53357</b></p>  <p>Beacon LED Flexi 12/24V</p>	<p><b>53358</b></p>  <p>** USE 53855 WHEN STOCK GONE **</p>
--	---	---	---	--	--

<p><b>43190K</b> Beacon Work Lamp Bracket Kit Left Side</p> <p>Kit includes:</p> <ul style="list-style-type: none"> <li>• Beacon Bracket Assembly</li> <li>• Work Lamp 8 LED 24W Flood 1920 Lumen</li> <li>• Flexi Beacon</li> </ul>  <p><b>43501K- Right Hand Kit</b></p>	<p><b>53857 Beacon Kit</b></p> <p>Includes: Beacon, Bracket, Wiring, Fuse &amp; Switch</p> 	<p><b>43592</b> Beacon Kit Case Puma Series, Maxxum Series <a href="#">OE Ref: 710762034</a></p> <p>Includes: Beacon, Cable Connections, Bolt Fixing Set, Beacon Pole, Brackets</p>  <p><b>43628 - Beacon Only</b></p>
--	---	--

## Brackets

<p><b>51388</b> Beacon Bracket Spring Loaded</p> 	<p><b>51388B</b> Bracket Angled for 51388 Beacon Bracket 42 43 61 62 81 82</p> 	<p><b>43190</b> Beacon Bracket Assembly Ford 5640 6640 7740 7840 8240 8340 LH</p> <p><b>43501</b> Beacon Bracket Assembly Ford 5640 6640 7740 7840 8240 8340 RH</p> 	
<p><b>3686</b> Beacon Bracket</p> 	<p><b>51034</b> Beacon Bracket Adjustable</p> 	<p><b>3680</b> Beacon Plug</p> 	<p><b>51417</b> Beacon Bracket John Deere</p> 
<p><b>51422</b> Beacon Bracket</p> 	<p><b>51387</b> Beacon Bracket</p> 	<p><b>3687</b> Beacon Bracket</p> 	<p><b>51421</b> Beacon Bracket Adaptor</p> 

# Clutch, Transmission & PTO



Model	Kit	Pressure Plate	Main Disc	Pto Disc	Release Bearing	Pto Bearing	Pilot Bearing	Ware Ring
374 384 414 434 444		 2280075	 2652246	 899823	 52320		 62042RS	
385 395 454 474 475 484 485 495 574 584 585 595 674 684 685 695 784 785 795 884 894	 2786 684 784 6 Paddle Clutch Aligning Tool = 43121 2787 684 784 8 Paddle Clutch Aligning Tool = 43121				 1069		 62042RS	
385 454 464 474 475 484 485/L/XL 495/L/XL 574 674 685 695 784 785L/XL 884 885L/XL 895XL 995/L 42'S	 4961 Clutch Aligning Tool = 43121  52199	 4369			 1069		 62042RS	 3581
856 856XL 995 955XL 956 956XL 995 995XL 1055 1055XL 1056 1056XL	 4764	 4768 Bolt Set to conv.1055 to 956XL			 3999	 60152RS 53205	 62042RS	
946 1046		 4769			 3999	 60152RS 53205	 62042RS	
CX80 CX90 CX100	 52057				 1069		 62042RS	
MXM120 MXM130 13"	 41843				 41306			



# Clutch, Transmission & PTO

Date:.....

No. of Pages:.....

Name of the Rep.....

A/C Number:.....

From:.....

e-mail.....

Phone No.:.....

Fax No.:.....

Please quote for the following parts - Quotation Number :

I wish to confirm the following order on Quotation Number:

Please supply the following parts:

	Qty	Part No.	Description	Unit Price
1.				
2.				
3.				
4.				
5.				
6.				
7.				
8.				
9.				
10.				
11.				
12.				
13.				
14.				
15.				
16.				
17.				
18.				
19.				
20.				
21.				
22.				
23.				
24.				

Please photocopy this page

Please do not remove this page

Comments:

Customer Signature:

Rep's Signature:

Tel No: + 353 44 934 1638

e-mail: [info@qtponline.com](mailto:info@qtponline.com), [www.qtponline.com](http://www.qtponline.com)

Page  of

## Clutch Parts

### 52742

Clutch Kit IHC 12" c/o Flywheel IHC 885 IHC 12"  
5 piece kit (ware plate, flywheel & 2



### 52203

Clutch Kit IHC 845XL 845 743 743XL 644 744  
844 844S 844XL 12" Dual

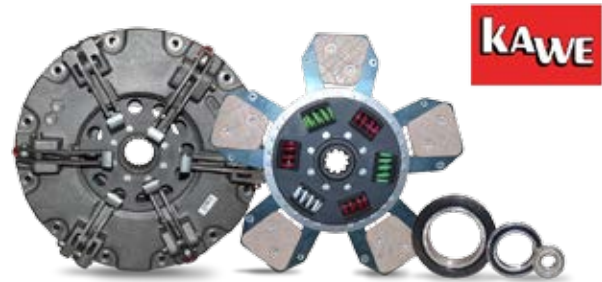

### 52263

Clutch Assembly Case 574 584 684 784 884  
385 485 485XL 685 685XL 785 785 XL 585  
585XL 395 395XL 495 495XL 595 595XL 695  
695XL 795 895



### 52495

Flywheel IHC 474 574 674 585  
595 684 685 784 785 3230 11"  
126 Teeth OE Ref: [31360441R11](#)



### 52073

Flywheel IHC 885 128 Teeth 9397-> 884  
885 885XL 895 895XL Suits 12" Clutch



### 52202

Clutch Assembly IHC 845XL 845 743 743XL 644 744  
844 844S 844XL 12" Dual



### 52201

Clutch Disc IHC 845XL 845 743 743XL 644 744 844 844S  
844XL 12" 10 Splines

## 52499

Clutch Kit Case CX50 CX60 CX70  
OE Ref: 85104C92

Includes LuK Bearings



## 52500

Clutch Kit Case 633 640 733 740  
OE Ref: 3055431R91

Includes LuK Bearings



## 52501

Clutch Kit Case 833 840 933 940  
OE Ref: 3055431R91

Includes LuK Bearings



## 52350

Clutch Kit Case CX80 90 100 c/o 7  
Paddle Disc (1069 RELEASE bearing to  
suit ) OE Ref: 223807A1 & 341723A1

Includes LuK Bearings



## 52367

Clutch Kit IHC 1255 1255XL 1455 1455XL  
OE Ref: 1964090C1

Includes LuK Bearings



## 52502

Clutch Kit Case 2120 2130 2140 2150  
OE Ref: 1966557C1

Includes LuK Bearings



## Clutch Parts

**52509**

Clutch Kit CS68 Cs75 Up To Serial Number 0023065 [OE Ref: 47437756](#)

**Includes LuK Bearings**



**52063**

Clutch Kit Case CS94 13" Steyr 9078 and 9094



**52351**

Clutch Kit Case CS78 CS86 CS94 Steyr M9078 M9083 M9094 M9100 [OE Ref: 14010016004](#)

**Includes LuK Bearings**



**52510**

Clutch Kit Case 48 58 68 75 [OE Ref: 87302841](#)

**Includes LuK Bearings**



**42970**

Clutch Disc Case MXU115 [OE Ref: 5196055](#)



**52231**

Clutch Plate Case IH MXM100 MXM115



**42969**

Clutch Assembly Maxxum 115 125 MXU115 [OE Ref: 5196057](#)



**43470**

Clutch Damper Case Maxxum 110 110 120 130 MXU100 110 [OE Ref: 47127700](#)



**41863**

Clutch Damper Case MXM120 130 140 155 175 190 And Puma [OE Ref: 5185207](#)



**52228**

Clutch Damper Case MX100 MX110 MX120 MX135 MX150 MX170 MTX155



**41036**

Clutch Damper MXM135, MXM150, MXM165, MXM180

**NEW DESIGN**



**43469**

Clutch Damper Case MXM115 MXM125 MXM135 [OE Ref: 47127699](#)





## Clutch Parts

**43670**  
Clutch Kit Case JX90 Maxxima  
OE Ref: 5097927, 84177326

Includes LuK Bearings



**43490**  
Clutch Kit Case JXs JXUs  
OE Ref: 5167935

Includes LuK Bearings



**42885**  
Clutch Assembly Case JX75, JX80  
OE Ref: 9973691

Includes LuK Bearings



**52368**  
Clutch Kit Case JX90 Maxxima JX95OE  
Ref: 5092803

Includes LuK Bearings



**41798**  
Clutch Assembly  
Case JXU Dual Fits JXTD 310 Dual  
OE Ref: 9973687



**42971**  
Clutch Damper Case JX70U JX80U  
JX90U JX100U OE Ref: 5181872



**43670**  
Clutch Kit Case JX90 Maxxima  
OE Ref: 5097927, 84177326

Includes LuK Bearings



**41268**  
Clutch Assembly Case JX100  
U, JX1070 U, JX1080 U, JX1090  
UOE Ref: 5167939



**41269**  
Clutch Disc Case JX100 U,  
JX1070 U, JX1080 U, JX1090 U  
OE Ref: 87716700

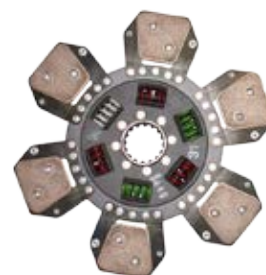

**42972**  
Clutch Damper Case JX100  
U, JX1070 U, JX1080 U,  
JX1090 U, JX1100 U, JX70  
U, JX80 U, JX90 U OE Ref:  
87527552



## Clutch Parts

### Ring Gears

#### 2108

Ring Gear IHC 484 584 674  
784 - 126 Teeth 3210 3220  
3230 4210 4220 385 485  
585 685 785 885 278 454  
474 574



#### 51001

Ring Gear IHC 885 956  
42'S 128 Teeth 288 4230  
4240 884 885 885XL  
895 895XL



#### 52311

Ring Gear Case 844  
845 856 955 956  
1055 1056 1255  
OE Ref: 3144607R1



#### 51233

Clutch Release Bearing Carrier IHC 385 395 45 484 485  
495 574 584 585 595 674 684 685 695 7 785 884 885  
Industrial 238 248 258 268 288



#### 51232

Clutch Release Bearing Carrier IHC 385 485 49 595 685 695  
785 795 885 895 995XL 3210 3220 3 4210 4220 4230 4240  
Industrial 238 248 258 26



#### 42100

Clutch Cable Case  
CS78 CS86 CS94



#### 52389

Foot Clutch Pedal  
Sensor Case  
McCormick



#### 52390

Foot Clutch Pedal  
Sensor Case  
McCormick



#### 43623

Spring Clutch Pedal  
Maxxum/Puma Series  
OE Ref: 84561533



#### 53417

Clutch Aligning Tool  
IH \*\* Suits 2786 2787  
4961 \*\* OE Ref:

## Clutch Parts



**1887**  
 Repair Kit Brake Slave Cylinder  
 - Case 1194, 1294, 1394  
 21.2mm [OE Ref: K965723](#)



**4122**  
 Clutch Slave Cylinder  
 Repair Kit Case 1194



**52288**  
 Clutch Master Cylinder Case CX 50 60 80 90  
[OE Ref: 3129807R92](#)



**52191**  
 Clutch Slave Cylinder Case CX100 CX50 CX60 CX70  
 CX80 CX90 Mc Cormick CX75 100 50 60 70  
[Repair Kit is 1521](#)



**1521**  
 Repair Kit IHC 885XL Clutch Slave Cylinder 48 495XL 585XL  
 595XL 685XL 695XL 785XL 795XL 885XL 895XL 995XL 3210  
 3220 3230 4210 4220



**42889**  
 Clutch Master Cylinder Case CX50 - CX100  
 McCormick CX70 - CX100



**1515**  
 Repair Kit IHC 485XL 495XL 585XL 595XL 685XL 695XL 785XL  
 795XL 885XL 895XL 995XL 3210 3220 3230 4210 4220 4230  
 4240 CX70 80 90 100 Master Cylinder Clutch & Brake

## Transmission Parts



**52064**

PTO Input Shaft IHC  
685 785 885 XL - 20.6 m



**52018**

Spigot Shaft Seal IHC

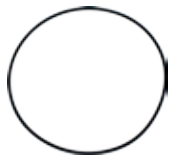

**51264**

Input Housing O  
Ring IHC 132.94  
x 3.53mm Nitrile  
70 Shore



**51265**

Input Housing  
Seal IHC



**51261**

Input Housing  
Seal Kit IHC



**52387**

Shift Lever McCormick 3  
Speed Extra Shift



**52393**

Solenoid Valve Case  
McCormick CX



**52318**

Drive Plate Case CS110  
CS120 CS130 CS150 \*\* 8 per  
Tractor \*\*  
OE Ref: 299531A1



**52489**

Sealing Ring 10s 20s 30s 40s  
Cs CXs MXs Transmission  
Forward Reverse 32.81mm ID x  
36.13mm OD x 2.38mm Thick  
OE Ref: A175509

## Transmission Parts

52707



Gear Selector IHC

52708



Gear Selector IHC

52709



Gear Selector IHC 885

52710



Gear Selector IHC Low

**43676**

Synchroniser 24 x 24 Transmission  
Case Maxxum MXU Series  
[OE Ref: 47124378](#)



**43473**

Clutch Disc Ford T6 TSA\*\* 409885 is  
Wave Spring \*\* 52439 is Friction \*\* 4 per  
Tractor \*\*  
[OE Ref: 5199726](#)



**52349**

Steel Plate Case Maxxum 100 110  
115 120 125 130 140 MXU 115 100  
110 125 130 135 Steyr CVT6130 6160  
6125 6115 6135 6140 4130 4115  
[OE Ref: 5199727](#)



**52333**

Steel Plate Case Maxxum 125 100  
110 115 120 130 140 MXU115 100  
110 125 130 135 \*\* Steel Disc is  
43472 \*\* [OE Ref: 5199723](#)



**43472**

Clutch Disc Ford T6 TS\*\*  
Clutch Disc is 52333 \*\* 9  
per Tractor\*  
[OE Ref: 87704110](#)



**52317**

Clutch Plate Disc Case IH  
Maxxum - 100 110 115 120 125 130 135  
140 145 150  
MXM - 175 190  
MXU - 100 110 115 125 130 135  
PUMA, CVT, CVX  
[OE Ref: 5163844](#)

## P.T.O. Parts



**51014**  
PTO Shaft Case Maxxum MX80-170



**404603**  
PTO Shaft Case JX100 U, JX70 U, JX80 U, JX90 U



**7478**  
PTO Shaft 1000rpm JX1060 C, JX1070, JX1075, JX1080 U, JX1090 U, JX1095, JX55, JX60, JX65, JX70, JX75, JX80, JX85, JX90, JX95 MXM135, MXM150, MXM165, MXM180



**43684**  
PTO Speed Sensor Case Farmall Series / Maxxum Series OE Ref: 47767004



**52070**  
PTO Guard Case 784 884 885



**52830**  
Switch PTO Case MX Series



**52448**  
PTO Cable Case MXM120 MXM130 MXM135 MXM140 MXM150 MXM155 MXM165 MXM175 MXM180 MXM190 Ford TM115 TM120 TM125 TM130 TM135 TM140 OE Ref: 87331793



**52278**  
Switch PTO Command Case IH Push Release OE Ref: 89520C91



**43604**  
PTO Solenoid Case Farmall Series Puma Series Puma CVT Series Puma CVX Series Steyr OE Ref: 87739558



**409677**  
PTO Switch MXM120, MXM130, MXM140, MXM155

## P.T.O. Parts

**52353**

Clutch Disc 7100 7200 8900 MX  
OE Ref: 87774811



**52352**

Steel Disc Case 7100 7200 8900 MX  
OE Ref: 92934C2



**52024**

Torque Pack Repair Kit IHC 585 885 685 785  
885XL 42's

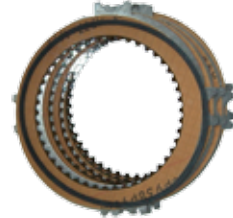

**52022**

PTO Pack Repair Kit IHC 474 885 (L/Duty)  
385 395 674 484

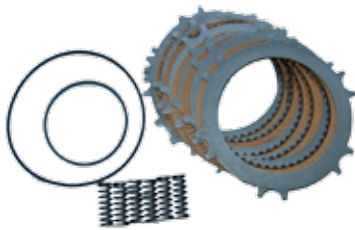

**52316**

PTO Clutch Plate Case 5120 5130 5140  
5150 5220 5230 5240 5250 MX100  
MX100C MX110 MX120 MX135 MX150  
MX170 MX80C MX90C  
OE Ref: A175806



**52315**

PTO Clutch Disc Case 5120 5130 5140  
5150 5220 5230 5240 5250 MX100  
MX100C MX110 MX120 MX135 MX150  
MX170 MX80C MX90C OE Ref: 1997129C1



**52008**

PTO Friction Disc Case 685 785 885XL  
4200 385 395 474 484 674 885



**52009**

PTO Disc Case 685 785 885XL 4200 Steel



**52871**

PTO Disc IHC 474 484 885 Steel 385 395  
474 484 674 885



**52869**

IPTO Pack Spring IHC  
385 395 474 484 674  
885 34mm long



**52870**

IPTO Pack O Ring  
IHC 385 395 474 484  
674 885



**52613**

O Ring To Suit IH  
PTO Pack 885



**7452**

PTO Seal  
68 x 90 x 10mm JX1060 C,  
JX1070, JX1075, JX1080 U,  
JX1090 U, JX1095, JX55,  
JX60, JX65, JX70, JX75, JX80,  
JX85, JX90, JX95 MXM135,  
MXM150, MXM165, MXM180



**7427**

PTO Seal JX1060, JX1060 C,  
JX1070, JX1070 C, JX1075,  
JX1075 C, JX1095

# Brakes, Linkage & Hydraulics



**Date:**..... **No. of Pages:**.....

**Name of the Rep:**..... **A/C Number:**.....

**From:**..... **e-mail:**.....

**Phone No.:**..... **Fax No.:**.....

Please quote for the following parts - Quotation Number :

I wish to confirm the following order on Quotation Number:

Please supply the following parts:

Please photocopy this page

Please do not remove this page

	Qty	Part No.	Description	Unit Price
1.				
2.				
3.				
4.				
5.				
6.				
7.				
8.				
9.				
10.				
11.				
12.				
13.				
14.				
15.				
16.				
17.				
18.				
19.				
20.				
21.				
22.				
23.				
24.				

**Comments:**  
 \_\_\_\_\_  
 \_\_\_\_\_

**Customer Signature:** \_\_\_\_\_ **Rep's Signature:** \_\_\_\_\_

**Tel No: + 353 44 934 1638**

**e-mail: info@qtponline.com, www.qtponline.com**

**Page**  **of**



## Brake Parts

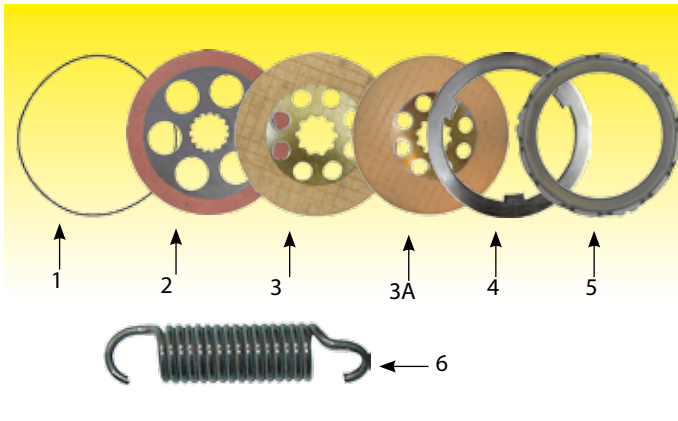

	Part No	Description
1.	<b>1380</b>	684 "O" Ring
2.	<b>3878</b>	684 Brake Centre Disc
3	<b>3747</b>	856 Brake Friction Disc
3A.	<b>3748</b>	955/1055 Brake Friction Disc
4.	<b>3879</b>	684 Brake Ring
5.	<b>3895</b>	584/684/784 Brake Ware Plate
6.	<b>3876</b>	Return Spring lh 684 Brake, Clutch, Hitch

**52783**

Brake Disc  
Handbrake Case IH  
5120 - 5150 5220 -  
5250 MX100 MX110  
MX120 MX135 MX150  
MX170 MX80C  
MX90C MX100 C



**52784**

Brake Disc Case  
IH Maxxum 8 MX  
5120 5130 5140  
5220 5230 5240  
MX100 MX110  
MX120 MX135

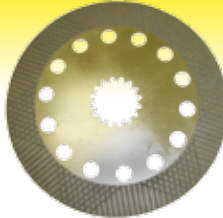

**52240**

Brake Disc Case IH  
940 433 533 633  
733 833 Diameter  
178mm



**52748**



Brake Actuator Case MX80C MX90C  
MX100 MX100C MX110 MX120 MX135  
MX150 MX170 5120 5130 5140 5220 5230  
5240 5250

**52239**



Brake Actuator Case IH 940  
433 533 633 733 833 Diameter  
178mm \*\* Disc is 52240 \*\*

**52122**



Ware Plate IHC 955/956/1055/1056 &  
XL Models Brake

### CVT6140-6195, CS 85-95, CS 80 Pro - CS 100 Pro

### MXM, Puma Series

**43467**



Brake Disc Ford T7510 T7520  
T7530 T7540 T7550 Case CS100Pro  
CS105Pro CS80Pro CS85Pro  
CS90PrCS95Pro CVX140 CVX150  
CVX160 CVX175 CVX195 OE Ref:  
87723854

**53786**



Disc Hand Brake Steyr 9080MT 9085MT  
9090MT 9095MT 9100MT 9105MT CVT6150  
6140 6160 61756195 CS80 85 90 95 100 105  
140 150 160 175  
OE Ref: 87723855

**43641**



Brake Disc Case Puma Series MXM Series  
Steyr 6130CVT 6145CVT  
OE Ref: 87397895

## Brake Parts

**1378**

BRAKE BAND IHC  
484 884 385XL 885XL  
395XL



**1898**

O Ring IHC Heavy Trumpet  
Housing

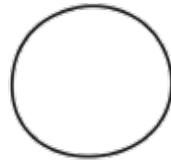

**2660**

Brake O Ring IHC  
Small 8 1/4" x 1/8"

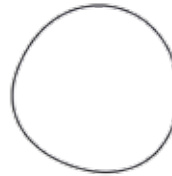

**52124**

Seal IHC 955 956 1055 1056  
& XL Models



**3881**

Oil Seal IHC 684  
Rear Axle Outer



**1513**

Hub Seal Leyland Front  
Hub Inner 2 3/4" x 3 1/2"  
x 3/8"  
**Kit=1920**



**1027**

Ware Ring IHC 474  
784 Rear Axle



**7800**

Brake Seal Small Case JX100U,  
JX1070U, JX1080U, JX1090U,  
JX1100U, JX70U, JX80U, JX90U



**7799**

Brake Seal Large Case  
JX100U, JX1070U, JX1080U,  
JX1090U, JX1100U, JX70U,  
JX80U, JX90U



**53185**

Cable Handbrake Case MX80 - 135 McCormick  
(1420mm)



**52273**

Cable Handbrake  
Case 844XL  
845XL 1056XL  
856XL 956XL

**53186**

Cable Handbrake Case CX  
McCormick CX  
(1000mm)



**409659**

Brake Switch Ford Hi/Low  
Forward / Reverse Clutch -  
Brake Light Case CS CVX JX **OE**  
Ref: 5163618



**42222**

Brake Light Switch Case JX1060 V  
JX1070 JX1075 **OE** Ref: 83952126

### 4985

Brake Slave Cylinder 1194, 1294,  
1394 Drum Brake Mineral Oil LHM  
OE Ref: K203416



### 4988

Brake Slave Cylinder Mineral 1194,  
1594, 1694 Oil LHM OE Ref: K200219



### 62837

Brake Master Cylinder Case  
1694,1494,1394,1594



### 43343

Brake Master Cylinder  
Case JX Series,  
JXU Series OE Ref:  
87354681



### 53193

Brake Master  
Cylinder Case MX80C  
90C 100 100C 110  
120 135 CX50 60 70  
80 90 100



### 52275

Brake Master  
Cylinder Case  
McCormick MTX MC  
Twin Fitted with PRV



### 42121

Brake Master  
Cylinder MXM175,  
MXM190 OE Ref:  
82037485



### 4192

Repair Kit Master Cylinder 1194  
OE Ref: K964572



### 1887

Repair Kit Brake Slave Cylinder Case  
1194, 1294, 1394 - 21.2mm



### 4745

Repair Kit Brake Slave Cylinder 1494,  
1594, 1694 - 24.3mm OE Ref: K965765



### 61331

Repair Kit Brake Master  
Cylinder 3 Pipe Cylinder IHC  
585 885 XL



### 1515

Repair Kit IHC 485XL 495XL  
585XL 595XL 685XL 695XL  
785XL 795XL 885XL 895XL  
995XL 3210 3220 3230 4210  
4220 4230 4240 CX70 80 90 100  
Master Cylinder Clutch & Brake



### 61330

Repair Kit Brake Master  
Cylinder  
Case / McCormick CX50  
CX60 CX70 CX80 CX90 CX



### 61699

Brake Master Cylinder  
Repair Kit Case IHC CS48,  
CS52, CS58, CS63, CS, CS75

## Hydraulic Pumps



**52186**  
Hydraulic Pump Case IH CS100  
CS110 CS120 CS130 CS150

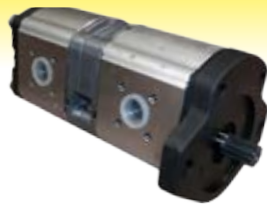

**52406**  
Hydraulic Pump Tandem Case CS78  
CS86 CS94 Bosch  
OE Ref: [0510765351](#)



**3843R**  
Hydraulic Pump IHC 684 784 Case  
McCormack CX 385 42 454 484 485 574  
584 585 595 XL 685 XL 784 785 884 885  
XL 89 XL CX [308873A1](#)

**53438** Seal Kit



**3085**  
Hydraulic Pump IHC 414 485  
354 374 384 444 B275 B414  
BD276 BD3434



**52200**  
Hydraulic Pump IHC 1255  
1255XL 1455 1455XL



**52209R**  
Hydraulic Pump Case IH 433 533 633 733  
833 440 940 743 743XL 644 744 844S 745S  
745XL 845 845XL



**52267**  
Hydraulic Pump Case IH 743  
743XL 844 844XL 745S 745XL  
845 845XL 856 856XL 724  
Bosch Pump



**52267R**  
Hydraulic Pump Case IH 743  
743XL 844 844XL 745S 745XL  
845 845XL 856 856XL 724  
OE Ref: [1986962C1](#)



**53349**  
Hydraulic Pump Case MX100  
MX100C MX110 MX120 MX135  
MX80C MX90C McCormick  
MC100 MC115 MC80 MC90  
MTX110 MTX125 MTX140

## Hydraulic Pumps



**7761**  
Hydraulic Pump Case JX LH  
Rotation  
OE Ref: 5129488 84530156



**7762**  
Hydraulic Pump JX70U JX80U JX90U  
JX100U JX1060C JX1070C JX1075C  
MXM120 MXM130 MXM140  
OE Ref: 5179726



**43336**  
Hydraulic Pump JX60, JX70,  
JX80 OE Ref: 87472286



**43633**  
Hydraulic Pump Case  
JXU OE Ref: 5167394



**43290**  
Hydraulic Pump MXU100, MXU110,  
MXU115, MXU125, MXU135  
OE Ref: 5198694



**43632**  
Hydraulic Pump  
Case Maxxum MXU 80L/MIN  
OE Ref: 0517625308



**52511**  
Hydraulic Pump Case Maxxum 5120 5130 5140 5150  
5220 5230 5240 5250 OE Ref: 1343659C2



**43634**  
Hydraulic Pump  
Case Puma Series  
OE Ref: 47135548

**Date:**..... **No. of Pages:**.....

**Name of the Rep.:**..... **A/C Number:**.....

**From:**..... **e-mail:**.....

**Phone No.:**..... **Fax No.:**.....

Please quote for the following parts - Quotation Number :

I wish to confirm the following order on Quotation Number:

Please supply the following parts:

Qty	Part No.	Description	Unit Price
1.			
2.			
3.			
4.			
5.			
6.			
7.			
8.			
9.			
10.			
11.			
12.			
13.			
14.			
15.			
16.			
17.			
18.			
19.			
20.			
21.			
22.			
23.			
24.			

**Comments:**

**Customer Signature:**

**Rep's Signature:**

**Tel No: + 353 44 934 1638**

**e-mail: [info@qtponline.com](mailto:info@qtponline.com), [www.qtponline.com](http://www.qtponline.com)**

**Page  of**

Please photocopy this page

Please do not remove this page

## Hydraulic Parts

**43631**  
Hydraulic Valve Section  
Case MXM Puma  
OE Ref: 5195165



**43601**  
Hydraulic Valve Section  
Case Maxxum MXU Puma -  
Electronic Operation  
OE Ref: 84125295

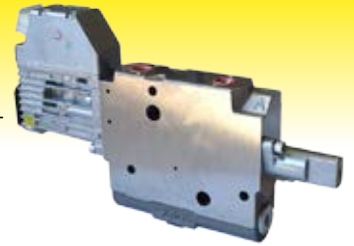

## Gaskets

**3843K**

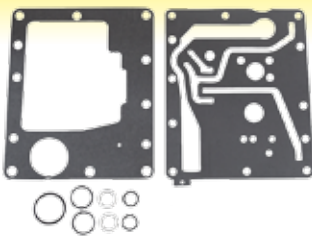

Hydraulic Pump Fitting Kit  
IHC 684 784 - **Pump -3843R**

**52044**



Hydraulic Pump Gasket  
IHC 684/784

**52046**



Hydraulic Pump Gasket IHC  
684/784

**52048**



Hydraulic Pump Gasket  
IHC 684/784

## "O" Rings

**52047**



O Ring IHC



**43474**  
Lift Cylinder To Lift Cover O  
Ring PTO Pack O Ring Ford  
35s 60s F L M TS T6 TL TLA  
TM TSA OE Ref: 14453181

**52043**

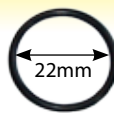

Hydraulic Pump O  
Ring IHC 684/784  
3/32"x 11/16"

**52042**



Hydraulic Pump O  
Ring IHC 684/784

**52045**

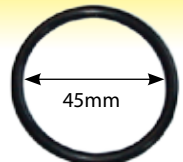

Hydraulic Pump O  
Ring IHC 684/784  
1/8" X 1.1/2"

## Seals

	Application	Model
<b>52338</b>	Seal Hydraulic PTO	Case MX MXC McCormick MTX TTX XTX
<b>52331</b>	Seal Transmission	Case Maxxum 5250 5130 5240 5150 5230 5220 5130 5140 5120 MX100 135 150 110 120 170 MXC80 100C 90C
<b>52335</b>	Seal Transmission	Maxxum 5250 5120 5130 5140 5150 5220 5230 5240 MX100 MX110 MX120 MX135 MX150 MX170 MX80C MX90C MX100C
<b>52322</b>	Seal Transmission Input	Case 3210 3220 3230 385 395 4210 4220 4230 4240 485 495 5120 5130 5140 5150 5220 5230 5240 5250 585 595 685



## Levelling boxes

### 1695

Levelling Box Assembly IHC  
385 395 395 XL 454 484  
485 485 XL 495 **OE Ref:**  
3069056R91



### 2173

Levelling Box Assembly Case  
IH 474,475,484,48 584,585,595,  
674,684,685,784,785,884,885



### 51012

Levelling Box Bottom Fork  
IHC 784



### 2113

Levelling Box Assembly  
IHC 595-995 885 - Wide



### 51116

Lift Rod Assembly IHC  
LH Long (Narrow Leg)  
Adj Min 575mm Max  
715mm



### 51117

Lift Rod Assembly IHC  
XL LH Long - Wide  
Leg  
Adj Min 570mm Max  
710mm



### 51013

Levelling Box Bottom  
Fork IHC XL - Wide



### 52145

Levelling Box Case  
MX150-170 (Hi Lift)

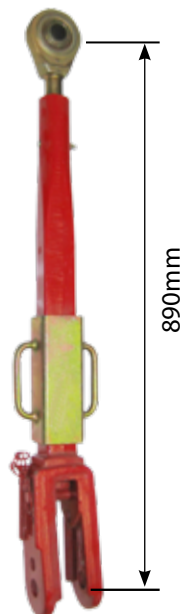

### 52143

Levelling Box Case 5120 -  
5150 5250 - 5250  
Maxxum 5100 & 5200 &  
MX80 - MX135  
(530-675mm)





## Levelling boxes

**52223**

Levelling Box  
Assembly Case 644  
744 844 844XL 745  
745XL 845 845XL  
1055 1055XL 955  
955XL



**43056**

TM175 TM190 Case  
CVX180 CVX195 CVX210  
CVX225 MXM175  
MXM190 PUMA165 180  
195 210



**52416**

Levelling Box Case 3000s  
4000s Cs CXs Min 590mm Max  
740mm  
OE Ref: 224250A1



**53211**

Levelling Box Assembly  
Case CX & McCormick

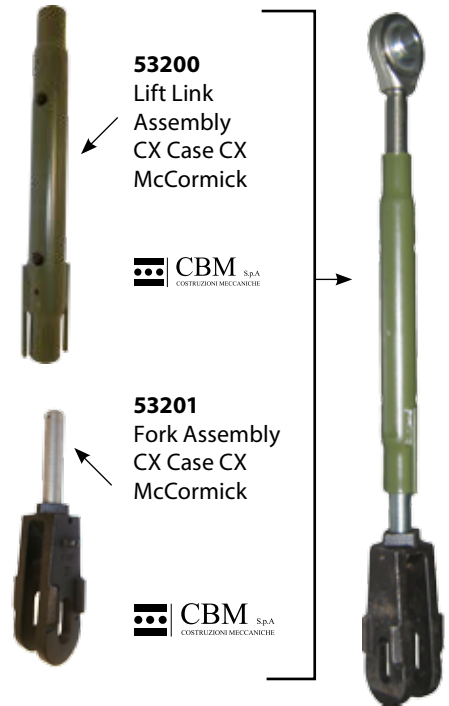

**1703**

Levelling Box Nut  
IHC (7/8 UNC)



**2574**

Levelling Shaft & Collar Case 784 995  
(462mm)



**2182**

Levelling Box Shaft IHC 574 674 784  
(423mm)

**2181**

Levelling Box Shaft IHC 454 485 495  
(368mm)

**181346**

Levelling Box Shaft 74/75/84/85/95  
330mm

**2319**

Levelling Box Yoke  
IHC 784 - 995 470mm



**2457**

Levelling Box Yoke IHC  
454 Short 345mm

**52062**

Levelling Box Bearing IHC



**52401**





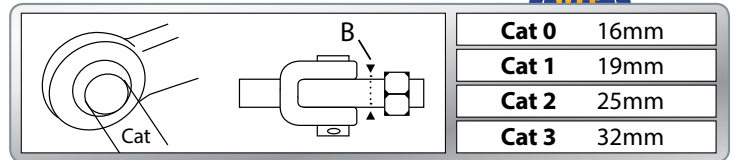



Rocker Shaft Case McCormick  
CS80 CS85 CS90 CS100  
OE Ref: 155700733070





## Linkage Parts

### STABILISERS

	Part	Applications	Cat	Min	Max	B
 320mm	<b>59652</b>	McCormick Case CX H Duty End = 51972	<b>1</b>	320	450	22
 520mm	<b>59651</b>	McCormick Case MX H Duty End = 51972	<b>1</b>	520	720	22
 411mm	<b>52458</b>	Case 5120 5130 5140 5150 5220 5230 5240 5250 MX100 MX100C MX120 MX135 MX80C MX90X OE Ref: 112923A1	<b>1</b>	411	670	24
  390mm	<b>52460</b>	Case 640 644 740 743 744 745 745S 840 844 844S 845 856 940 946 955 956 1046 1056	<b>1</b>	390	640	
	<b>1635</b>	IHC All Models 385 454 474 475 484 485 485 XL 574 584 585 585 XL 674 684 685 685 XL 784				
 430mm	<b>41763</b>	MXM120, MXM130, MXM140, MXM155, Heavy Duty OE Ref: 5170360	<b>1</b>	430	630	25
 430mm	<b>41763R</b>	MXM120, MXM130, MXM140, MXM155, Normal Duty End is 51978		430	630	25
	<b>52409</b>	Chain Stabiliser IHC 574 595 684 685 885 895		390		

## Linkage CBM Type

**59289**

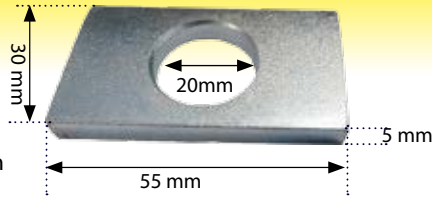

Pin Plate Square John  
Deere 6000  
20mm Hole

**59288**

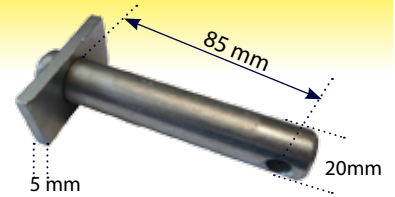

Lower Levelling Box  
Pin John Deere 6000

**41747**

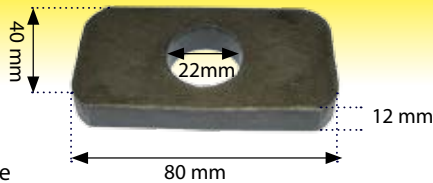

Bottom Fork Plate  
CBM Type 22mm

**41748**

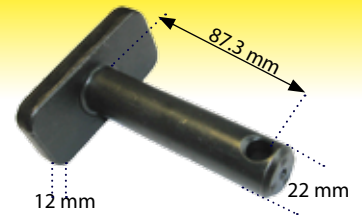

Bottom Fork Lift Link Pin  
CBM Type 22mm



**59822**

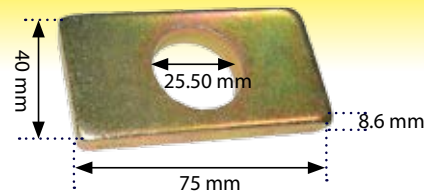

Fork Plate John  
Deere 76 77 7810  
Bottom

**41743**

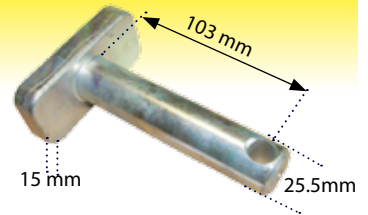

Bottom Fork Lift Link Pin  
CBM Type 25.50mm

**41740**

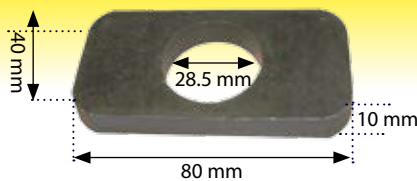

Bottom Fork Plate CBM  
Type 28.5mm hole

**41741**

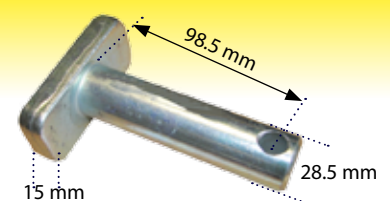

Bottom Fork Lift Link Pin  
CBM Type 28.5mm



**41744**

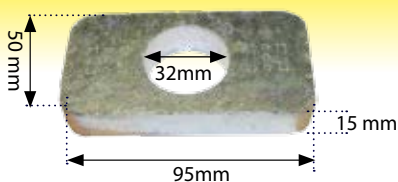

Bottom Fork  
Plate CBM Type  
32mm hole

**41745**

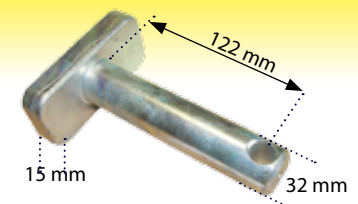

Bottom Fork Lift Link  
Pin CBM Type 32mm



# Brakes, Hydraulics & Linkage

## Lower Links

**4418** **Cat 2**



Link Ball Lower c/o Guide Cone Cat 2 \*\*\*Pin To Suit 4419\*\*\*

**4419**



Linch Pin for 4418  
12mm Diameter Pin

**4727**

**Cat 3/3**



Link Ball Cat 3/3 & Guide Cone  
\*\*\*Pin To Suit 4419\*\*\*

**4729**

**Cat 2/3**



Link Ball Cat 2/3 & Guide Cone  
\*\*\*Pin To Suit 4419\*\*\*

## Lower Link Balls

**53041**

**Cat 1/2**



Lower Link Ball Dual  
Cat 1/2

**2539**

**Cat 3/2**



Lower Link Ball Cat 3/2  
29 OD 63.5

**2540**

**Cat 3/3**



Lower Link Ball Cat 3/3  
ID 37.5mm OD63.5mm

**62228**

**Cat 2/2**



Ball Cat 2/2 For Lower  
Quick Release End

**53057**



Linch Pin & Grip Clip  
Assortment Pack  
Qty 50

**1869219**



Lift Arm Ball Clip

**886428**

**Cat 1**



Lower Link Ball Cat 1  
Interchangeable  
Fits 100 200 300 4200 4300  
600 Series

**886429**

**Cat 2**



Lower Link Ball Cat 2  
Interchangeable  
Fits 100 200 300 4200 4300  
500 600 Series

## Lower Link Conversion Bushes

**43155**

**Cat 2 to Cat 3**



Bush Lower Link Conversion  
Cat 2 to Cat 3

**53496**

**Cat 2 to Cat 3**



Bush Lower Link Conversion Cat 2 to Cat 3  
ID 1 1/8" OD 1 7/16" Length 2 1/2" 63.5mm

**2424**

**Cat 1 to Cat 2**



Lower Link Conversion Bush 1 1/8' to 7/8'

## Lift Arm Ends

### Quick Release Ends



**61226**  
 Quick Attach Hook Kit 6200 8200 Cat 3  
 Also fits John Deere



**59039**  
 Repair Kit Lower Link John Deere Ford  
 Fiat  
 Case Cat 3



**41936**  
 Lift Arm Latch Cat 3 M/60 40/  
 TM 30 Series

**63236**  
 Lever Quick Attach  
 CAT3 With Pin



**63237**  
 Lever Spring Cat 2 Cat 3  
 Quick Attach



**61227**  
 Quick Attach Hook Kit 390 4200 6200  
 Cat 2  
 Also fits John Deere



**59035**  
 Repair Kit Lower Link  
 John Deere Fiat Cat 2



**41937**  
 Lift Arm Latch Cat 2 7610 40 Series  
 John Deere \*\* Kit 59035 \*\*

**59058**  
 Lever Quick Attach  
 CAT2



**63237**  
 Lever Spring Cat 2 Cat 3  
 Quick Attach

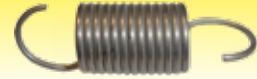

## Weld On Ends



**2407**  
 Weld on End Cat 1 Lift Arm



**2408**  
 Weld on End Cat 2 Lift Arm

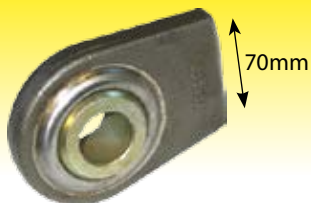

**4088**  
 Weld on End Cat 2 Heavy Duty  
 Lift Arm

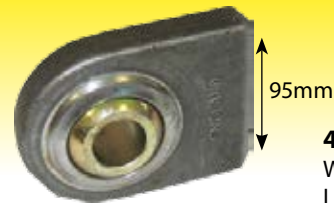

**4086**  
 Weld on End Cat 2 Heavy Duty  
 Lift Arm



**51095**  
 Weld on End Cat 1 Top Link



**51094**  
 Weld on End Cat 2 Top Link

## Top Links

**52459**

Top Link Case CS100 CS110 CS120 CS130  
 CS150 CVX1135 1145 1155 1170 1150  
 1195 CVX120 130 150 170 Ford TCT135  
 145 155 170 190 195 OE Ref: 132574312

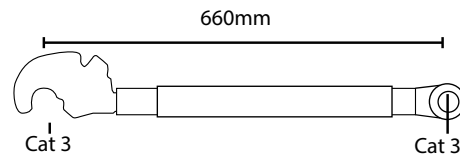

**52461**

Top Link Case Maxxum / MXU/Puma  
 OE Ref: 5197609

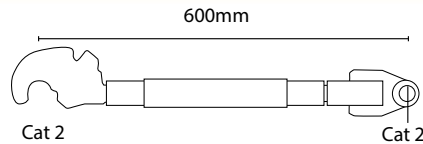

## Top Link Conversion Bushes

**21018**

Top Link Ball Cat 2/3  
 • I/D Ø: 1".  
 • O/D Ø: 2 23/64".  
 • Width: 2".

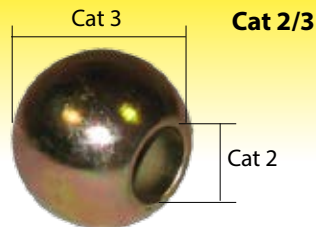

**21019**

Top Link Ball Cat 3/3  
 • I/D Ø: 1 9/32".  
 • O/D Ø: 2 23/64".  
 • Width: 2".



**4044**

Top Link Ball CAT 2



**21001**

Ball Cat 3 Toplink



## Top Link Conversion Bushes

**53475**



Bush Top Link Conversion  
 Cat 2 Cat 3

**42144**



Top Link Conversion Bush Ford 10  
 100 Cat 1/2  
 1000 30 40 Industrial TW Series

## Top Link Pin

**1292**

Top Link Pin IHC Cat 1





## Dromone

**DRA2268**

Hitch Ford TG Case Magnum  
Hyd. Push Back

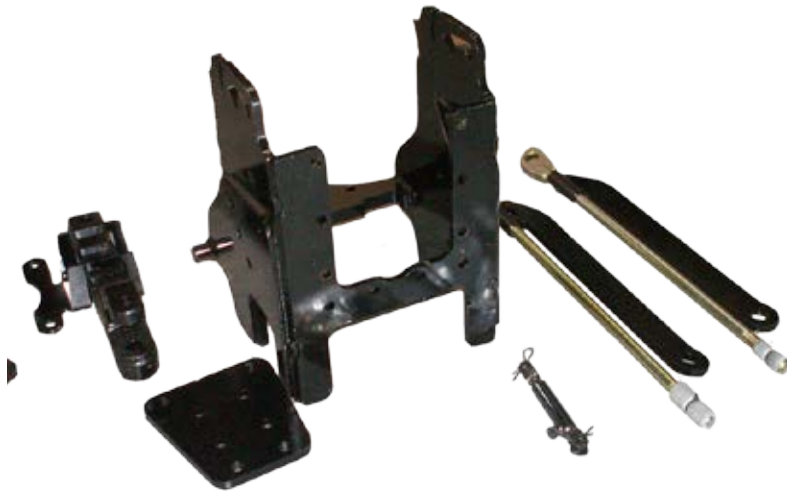

## Dromone Hitch Components

**DRSP30293G**

Drawbar Assembly ISO  
57.5mm centre to centre

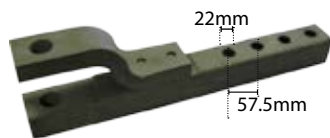

**DRSP30293**

Drawbar Assembly ISO

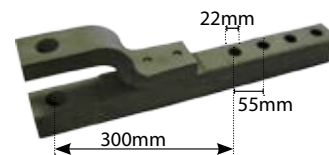
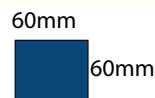

**DRP47901**

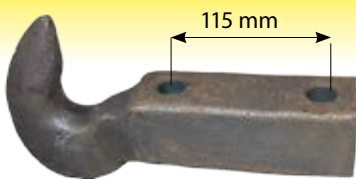

Pick Up Hitch Hook  
Dromone Head -  
60mm

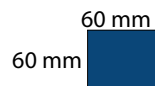

**DRSP30033**

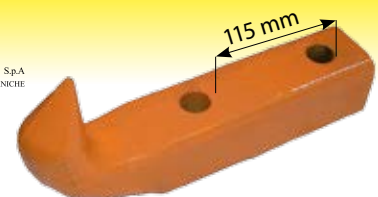

Pick Up Hitch Hook  
ISO 60mm 115mm  
btw Holes

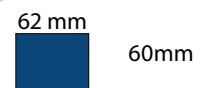



## Dromone

### Drop In Pins

**DRP48810**

Drop In Pin

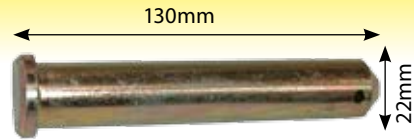

**DRP48832**

Drop In Pin

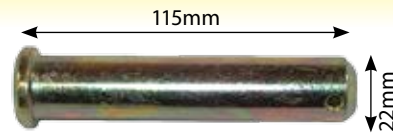

**DRP48818**

Drop In Pin - 2 Pin Type Push Back

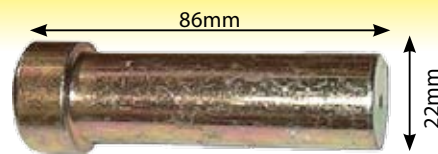

**DRP74753P**

Hinge Pin Sub Assembly

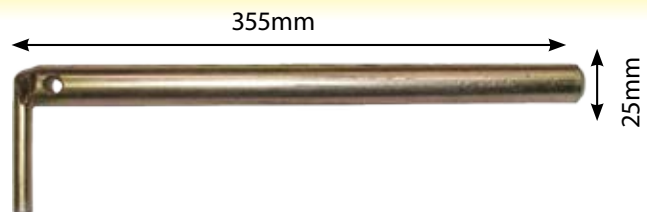

**DRSP30312**

Ram Hydraulic Release Dromone Hitch  
(Overall length 9 1/4" 23.5cm)



## Dromone Hitch Components

**DRP75302P**



Lift Rod Case Maxxum

**DRP79047**

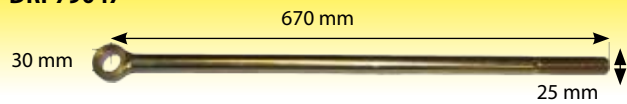

Lift Rod Case 844/955/956/1055/1055

**52737**



Pick Up Hitch Lift Rod Case 856 956 856XL  
956XL 1056XL 845XL 844XL

Nut is 1995



**52399**

Lift Rod Assembly Case 5120 5130 5140 5150 Overall 885mm  
OE Ref: 220373A1

Nut is 1996

**DRP44340**

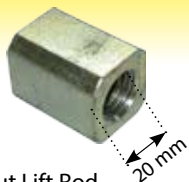

Nut Lift Rod  
20 mm

**DRP44341**



Nut Lift Rod  
25mm

**DRP43206**

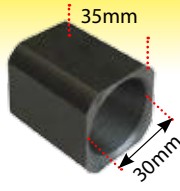

Nut spacer Lift Rod  
30mm (No Thread)

**DRP76810**

Case MX Slide Pipe  
Assy  
LH



**DRSP6029**

Bolt Kit Case CS



**DRSP6038**

Back Plate Case MX 30



**DRSP6005**

Ware Pads Case Maxxum (Short) PAIR



**DRP82235**

Bolt Kit MX30



**DRPF94118**

Lift Rod Nuts  
Case 956



## Cables



Part No	mm	Description
<b>52811</b>		Hitch Cable CX
<b>52259</b>		Cable Hitch Auto Case 56 Series 1056XL 956XL
<b>52812</b>		Hitch Cable CX105
<b>52074</b>	1640 mm	Pick Up Hitch Cable Case MX
<b>DRP59000</b>	1820 mm	Std Pull Cable For All Dromone Hitches
<b>DRP590001</b>	2030 mm	Pick Up Hitch Cable Landini Legend

## Latching Hook Kits

### Latching Hook Kit MXM

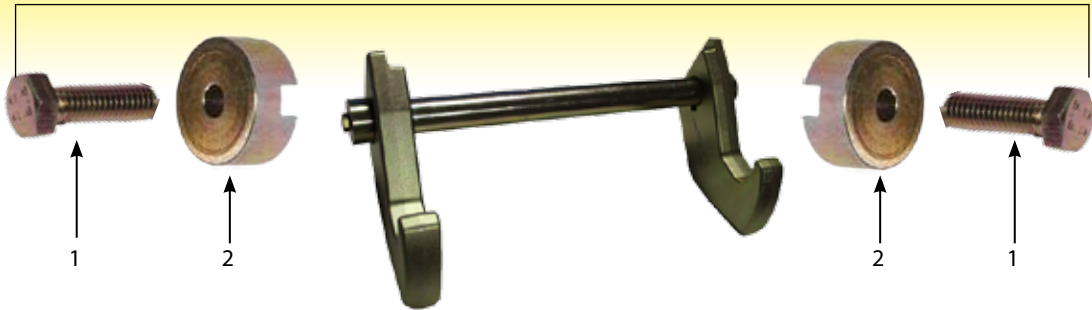

- 1. **3008**
- 2. **409752**

Bolt M8 x 25 Coarse Zinc & Yellow  
 Hitch Pin End Cap Ford 40 M TD TL TM TS

**Kit = 41792**

Latching Hook Kit  
 Includes End Caps and Screws

### Pick UP Hitch Latch Kit - 3 Hook 43638

CASE MAXXUM/MXM/ MXU/PUMA SERIES  
 STEYR CVT 6130-6230, PROFI 4000 SERIES

Description	Qty
1 Latch Right Hand	1
2 Latch Left Hand	1
3 Latch Centre	1
4 Spring Left Hand	1
5 Spring Right Hand	1
6 Key Way Left Hand/Right Hand	2
7 Keyway Centre	1
8 Shaft	1
9 Spacer	2
10 Bolt/Wash/Nut	4

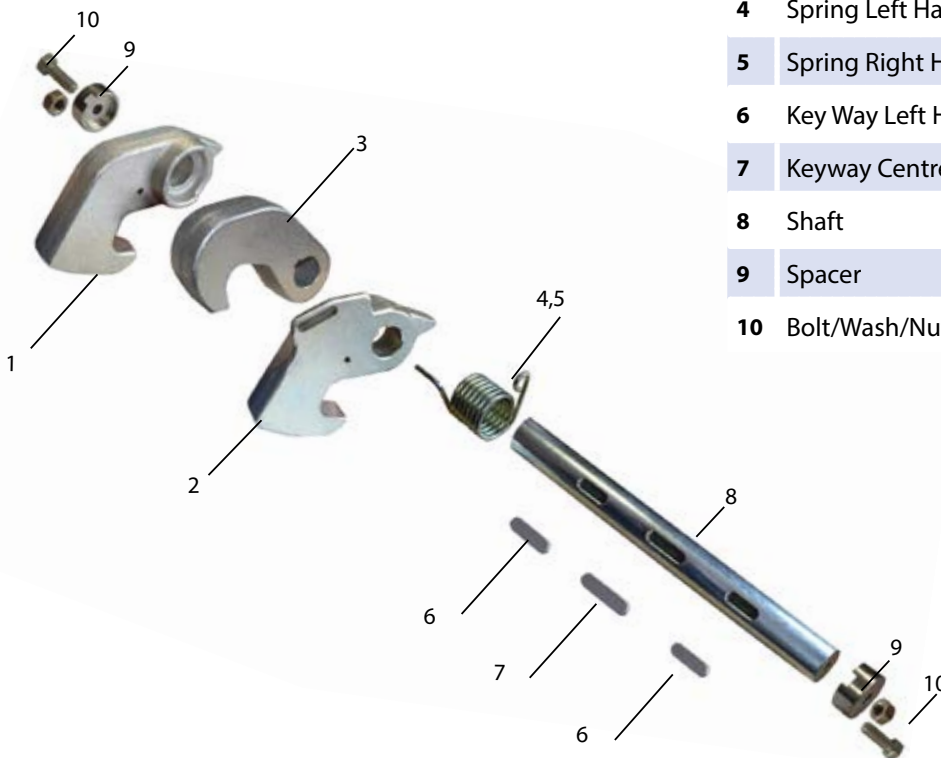



# K80 RANGE

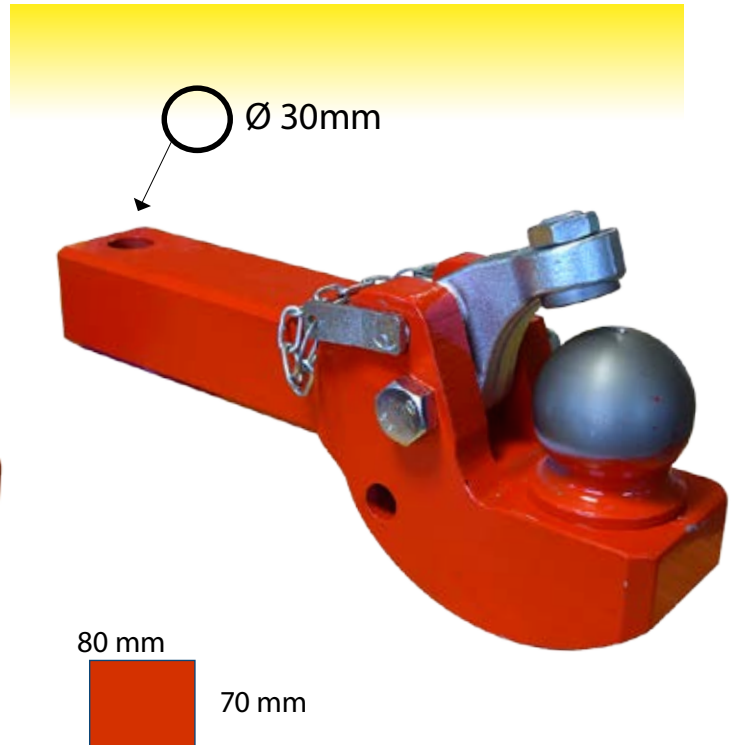
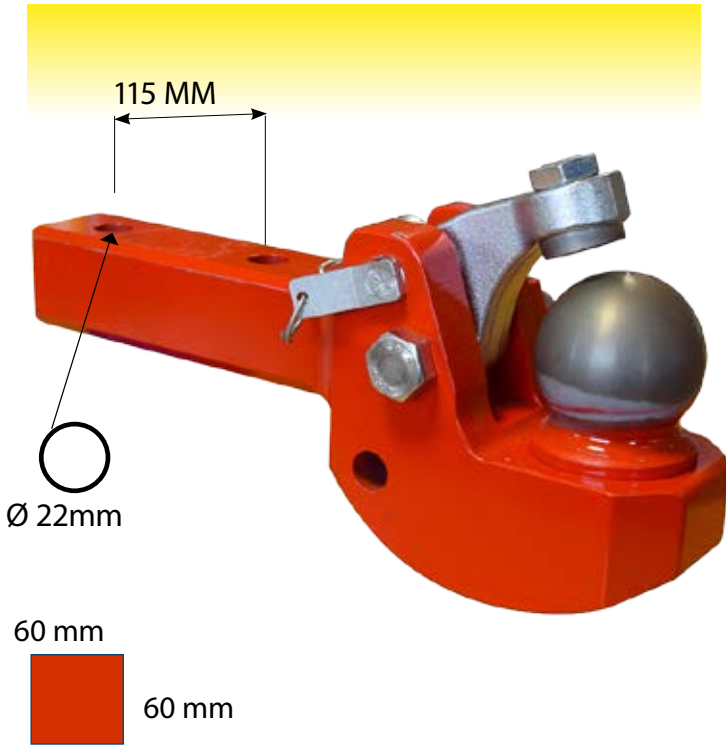

**58883** OE Ref: 00.421.10.2-A20

**Claas:** Ares 500/600 Arion 500/600  
**Fendt:** Vario 200/300  
**John Deere:** 7010, 8000  
**Massey Ferguson:** 5600 6445-6480 7600

**58884** OE Ref: 00.429.00.2-A20

**Claas:** Axion 800/900  
**Fendt:** Vario 700/800/900  
**John Deere:** 8030/8R  
**Massey Ferguson:** 6485-6499, 6485-6499, 7624, 7626, 8200: 8210, 8280; 8400  
**McCormick: MTX:** 165, 175, 185;  
**Valtra:** S-Series

## INTERCHANGEABLE WITH

**DRSP30033**  
oe ref: L156433



## INTERCHANGEABLE WITH

**DRP47902**  
oe ref: L156433



## 58837

Oe Ref: 00.651.90.0-A01

K80 Weld On Spoon Universal

80 mm  
60 mm



**ALLOWS TRANSMISSION OF HIGHER VERTICAL LOADS  
 PLAY - FREE CONNECTION, ELIMINATES RATTLE  
 GREATER ANGULAR MANEUVERABILITY  
 QUIETER TOWING  
 NO UPWARD MOVEMENT FOR TIPPING TRAILERS - RESULTS IN LESS WEAR**

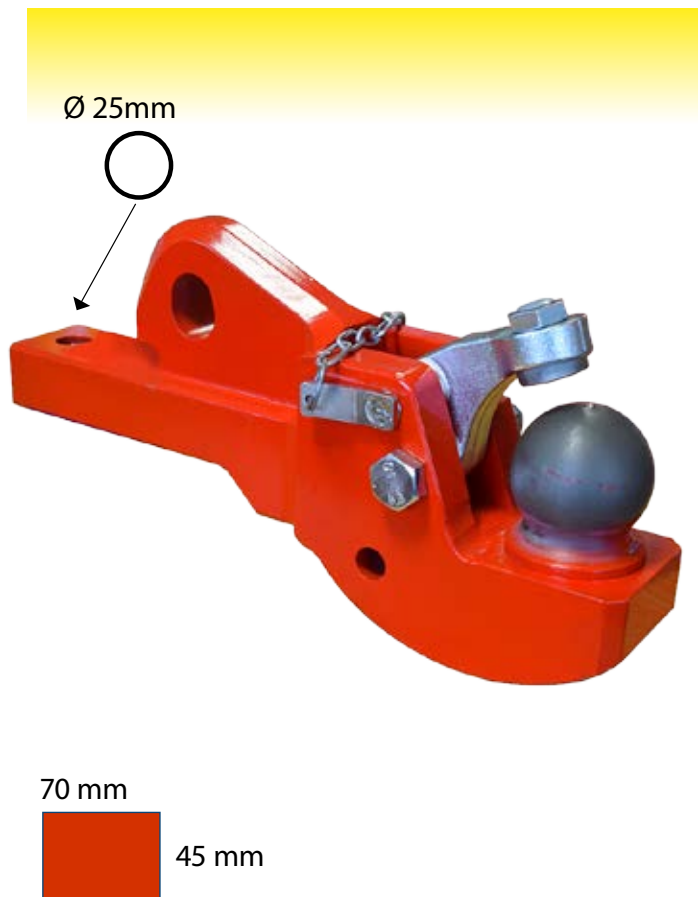

**58886** Oe Ref: 00.428.00.5-A20  
 John Deere: 6010, 6020, 6130, 6R, 7020, 7030, 8010, 8020, 8030

**53829** Oe Ref: 00.652.90.0-A02



K80 Towing Spoon 110 x 100mm

**53828**  
 K80 Weld On Plate  
 110 x 100mm



**53853**  
 Bolt Kit M16 x 60mm  
 10.9 Strength



**53827** Ref: 00.650.90.1-A02

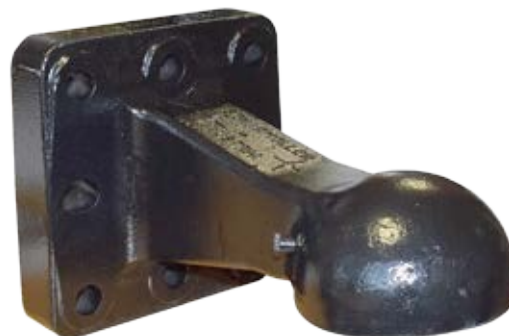

K80 Towing Spoon 145 x 145mm

**53830**  
 K80 Weld On Plate  
 145 x 145mm  
 OE REF:  
 00.645.00.0



**53854**  
 Bolt Kit M20 x 80mm  
 10.9 Strength



**INTERCHANGEABLE WITH**

**DRP00515**  
 oe ref: L156433,  
 AL159328

**DRP82406**  
 oe ref: AL159328,  
 L156433

