

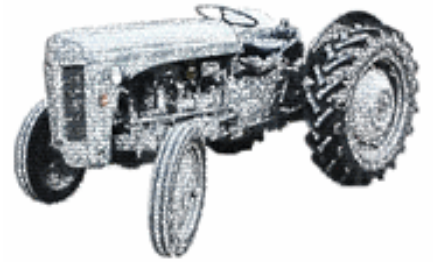

L.O.G Heigl



REPLACEMENT PARTS SUITABLE FOR
JOHN DEERE TRACTORS

Contents

Reliance

JD 6

Engine

JD 41



Gaskets

JD 41



Fuel Parts

JD 43

Fuel Lift Pumps

JD 46

Exhaust Parts

JD 49

Cooling

JD 56

Fan Belts

JD 58



Radiators

JD 72

Filters

JD 75



Oil Filters

JD 75



Fuel Filters

JD 76

Hydraulic Filters

JD 78

Air Filters

JD 81

Axle Parts

JD 104



Ball Joints

JD 104



Track Rod Ends

JD 106

Front Axle Parts

JD 108

Axle Transmission Parts

JD 109

Orbital Units

JD 116

Cab, Sheet Metal & Electrical

JD 117



Decal Kits

JD 118

SG2 Cab Parts

JD 120

Wiper Motors

JD 133

Glass

JD 138

Electrical Parts

JD 144



Clutch, Transmission & PTO

JD 158



Brakes, Hydraulics & Linkage

JD 172



Brakes

JD 172

Hydraulic Components

JD 178

Lift & Linkage

JD 184



Model	Pg.	Engine
1640	6	4-239D
1840	6	4-239D
2040S	6	4-239D
2130	6	4-239D ,4-276D, 4-276T
2135	6	4-239D
2140	8	4-239T
2250F	6	4-239D
2350	6	4-239D
2355CS	6	4-239D
2450	6	4-239D
2450F	6	4-239D
2535	6	4-239D
2550	6	4-239D
2555	8	4-239T
2555TSS	8	4-239T
2650	8	4-239T
2650F	8	4-239T
2650N	8	4-239T
2730	6	4-239D
2735	6	4-239D
2750	8	4-239T
2755	8	4-239T
2755CS	8	4-239T
2755TSS	8	4-239T
2850	8	4-239T
2855	8	4-239T
2855N	8	4-239T
2940	10	6-359D
2950	10	6-359D
2955	10	6-359D
3020	6	4-239D, 4-270D
3040	12	6-359T,A
3050	10	6-359D
3055	10	6-359D
3140	12	6-359T,A
3140C	12	6-359T,A
3150	10	6-359D
3155	10	6-359D
3155TSS	10	6059D, 6-359D
3210	10	6-359D
3255	12	6-359T,A
3300		4045D
3310	22	4045D Powertech
3310X	22	4045D Powertech
3330	6	4-239D

Model	Pg.	Engine
3350	12	6-359T,A
3400	14	4039T
3410	24	,H Powertech
3410X	24	4045T,H Powertech
3540	12	6-359T,A
3550	12	6-359T,A
3640	10	6-359D
3650	12	6-359T,A
4040	10	6-359D, 6-404D
4050	12	6-359T,A 6-466D"
4050E		6-466T
4250		6-466T
4280	10	6-359D
4350		6-466T
4440		6-466T
4450		6-466T
4485		6-466T
4530	10	6-359D
4685		6-466T
4890	24	4045T,H Powertech
4920		6081A,H Powertech
5410	22	4045D Powertech
5415	22/24	4045D Powertech 4045T, H Powertech
5420N	22	4045D Powertech
5500	8	4-239T
5500N	14	4039T
5510	24	4045T,H Powertech
5510N	24	4045T,H Powertech
5520N	24	4045T,H Powertech
5615	22	4045D Powertech
5700	14	4039T
5715	30	4045T,H Powertech High Horsepower
5820	30	4045T,H Powertech High Horsepower
6010	22	4045D Powertech
6010SE	22	4045D Powertech
6020	22	4045D Powertech
6020SE	22	4045D Powertech
6100		4045D
6100SE		4045D
6020	22	4045D Powertech
6110	30	4045T,H Powertech High Horsepower
6110L	30	4045T,H Powertech High Horsepower
6110SE	30	4045T,H Powertech High Horsepower
6120	30	4045T,H Powertech High Horsepower
6120SE	30	4045T,H Powertech High Horsepower
6200	14	4039T

Model	Pg.	Engine
6200L	14	4039T
6200SE	14	4039T
6205	24	4045T,H Powertech
6210	30	4045T,H Powertech High Horsepower
6210L	14	4039T
6210SE	30	4045T,H Powertech High Horsepower
6215	30	4045T,H Powertech High Horsepower
6220	30	4045T,H Powertech High Horsepower
6220SE	30	4045T,H Powertech High Horsepower
6300	14	4039T
6300L	14	4039T
6300SE	14	4039T
6310	30	4045T,H Powertech High Horsepower
6310L	30	4045T,H Powertech High Horsepower
6310S	30	4045T,H Powertech High Horsepower
6310SE	30	4045T,H Powertech High Horsepower
6320	30	4045T,H Powertech High Horsepower
6400	14	4039T 4045T,H
6400L	16	4045T,H
6410S	30	4045T,H Powertech High Horsepower
6410SE	30	4045T,H Powertech High Horsepower
6415	30	4045T,H Powertech High Horsepower
6420	30	4045T,H Powertech High Horsepower
6500	14	4039T
6500L	16	4045T,H
6505	19	6059T
6506	19	6059T
6510	22/26	4045D Powertech
6510L	30	4045T,H Powertech High Horsepower
6510S	30	4045T,H Powertech High Horsepower
6510SE	26	6068D Powertech
6515	26	6068D Powertech
6520	26	6068D Powertech
6520SE	26	6068D Powertech
6600	19	6059T
6603	20	6068T,H Powertech
6605	32	6068T,H Powertech High Horsepower
6610	32	6068T,H Powertech High Horsepower
6610SE	32	6068T,H Powertech High Horsepower
6615	32	6068T,H Powertech High Horsepower
6620	32	6068T,H Powertech High Horsepower
6715	32	6068T,H Powertech High Horsepower
6800	20	6068T,H
6810	30	4045T,H Powertech High Horsepower
6820	32	6068T,H Powertech High Horsepower
6900	20	6068T,H
6910	32	6068T,H Powertech High Horsepower

Model	Pg.	Engine
6910S	32	6068T,H Powertech High Horsepower
6920	32	6068T,H Powertech High Horsepower
6920S	32	6068T,H Powertech High Horsepower
7200	19	6059T
7210	32	6068T,H Powertech High Horsepower
7400	20	6068T,H
7405	32	6068T,H Powertech High Horsepower
7410	32	6068T,H Powertech High Horsepower
7420	32	6068T,H Powertech High Horsepower
7500	32	6068T,H Powertech High Horsepower
7510	32	6068T,H Powertech High Horsepower
7520	32	6068T,H PowertechHighHorsepower6-531A
7600	20	6068T,H
7610	32	6068T,H Powertech High Horsepower
7700	35	6076T, A, H
7710	36	6081A,H Powertech
7800	35	6076T, A, H
7810	36	6081A,H Powertech
7820	36	6081A,H Powertech
7920	36	6081A,H Powertech
8100	35	6076T, A, H
8100T	36	6081A,H Powertech
8110	36	6081A,H Powertech
8110T	36	6081A,H Powertech
8120	36	6081A,H Powertech
8120T	36	6081A,H Powertech
8200T	36	6081A,H Powertech
8210	36	6081A,H Powertech
8210T	36	6081A,H Powertech
8220	36	6081A,H Powertech
8220T	36	6081A,H Powertech
8300T	36	6081A,H Powertech
8310	36	6081A,H Powertech
8310T	36	6081A,H Powertech
8320	36	6081A,H Powertech
8320T	36	6081A,H Powertech
8400	36	6081A,H Powertech
8400T	36	6081A,H Powertech
8410	36	6081A,H Powertech
8410T	36	6081A,H Powertech
8420	36	6081A,H Powertech
8420T	36	6081A,H Powertech
8520	36	6081A,H Powertech
8520T	36	6081A,H Powertech
9100	36	6081A,H Powertech
9120	36	6081A,H Powertech
942	6	4-239D
945	8	4-239T
952	8	4-239T

4-239D Engine

300 Series 239 inches 4 Cylinders

Engine Overhaul Kits

	Part No.	Description	92000 Standard Overhaul Kit	92010 .010" Kit	92020 .020" Kit	Bore
1	QRE30250	Cylinder Kit*	4	4	4	106.5
1A	QAR65507	O Ring Kit	4	4	4	
2	QRE501579	Gasket Set	1	1	1	
3	QAR67942	Seal Front	1	1	1	
4	QR78598	Thrust Washer for Flange-less Bearing	4	4	4	
5	QR57160	Balance Bush	6	6	6	
6	QR55647	Rod Bush	4	4	4	
7	QRE44574	Seal Rear	1	1	1	
8	QAR81786	Thrust Bearing STD	1			
9	QRE27348	Rod Bearing STD	4			
10	QRE27352	Main Bearing STD	4			
11	QAR81788	Thrust Bearing 10 Thou		1		
12	QRE27349	Rod Bearing 10 Thou		4		
13	QRE27353	Main Bearing 10 Thou		4		
14	QAR81789	Thrust Bearing 20 Thou			1	
15	QRE27358	Rod Bearing 20 Thou			4	
16	QRE27360	Main Bearing 20 Thou			4	

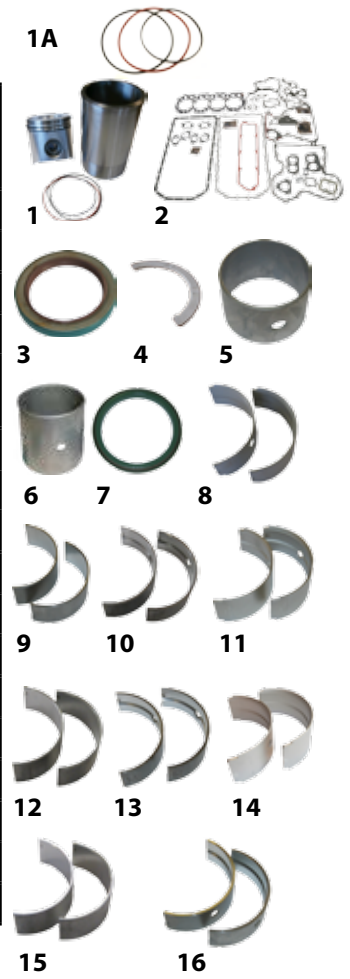

*Head Set QRE38851 Contains		
R73521-B	Gasket, Rocker Cover, 4 Cyl	1
R97354-B	Gasket, Inj Pump Mount	1
R105346-B	Gasket, Turbo Oil Outlet	1
R97348-B	Gasket, Turbo Oil Inlet	1
R89879-B	Gasket, Turbo Mount	1
R56463-B	O-Ring, Vent Tube Outlet	1
R54641-B	Gasket, Thermostat to Cyl Head	1
R54638-B	Gasket, Thermostat Cover, Dual	1
R48000	Seal, Pencil Injector	4
R90658	Gasket, Exhaust Manifold	4
R87627	O-Ring, Valve Stem	8
R81275	Gasket, Air Inlet	1
R60746	Seal, Pencil Injector	4
T20219	Gasket, Thermostat Housing	1
PM-771	Bag, 6X8 Plain, Sharp	1
NT20215	Gasket, Thermostat Cover	1
R125863-B	Gasket, Cyl Head, 4 Cyl,	1
**Oil Pan Set QRP341 Contains		
R74354	O-Ring	1
R75892	O-Ring, Oil Supply Tube	1
R77052	O-Ring	2
R79563	Sleeve, Rubber	1
R97342	Gasket, Oil Pan, 4 Cyl,	1

***Conversion Set QRP682 Contains		
A4730R	O-Ring, Oil Pump Intake	1
R116025	Gasket, Water Pump Mount	1
R495R	O-Ring, Ventilator Tube	1
R52811	O-Ring, Inlet, Outlet	1
R56192	O-Ring, Oil Cooler, Inner	1
R56193	O-Ring, Oil Cooler, Outer	1
R56461	O-Ring, Thermostat/Water Tube	1
R56814	O-Ring, Oil Cooler to Housing	1
R56815	O-Ring, Oil Cooler to Cooler	1
R61871	O-Ring	1
R70956	Packing, Oil Cooler	1
R74354	O-Ring	1
R75892	O-Ring, Oil Supply Tube	1
R77052	O-Ring	2
R79551	Gasket, Oil Cooler Cover	1
R90648	Gasket, Block to End Plate	1
R97346	Gasket, Water Line	1
R97350	Gasket, Fuel Transfer Pump	1
R97351	Gasket, Flywheel Housing	1
R97352	Gasket, Oil Filler Inlet	1
R97454	Gasket, Timing Gear Cover	1
R97773	Gasket, Cover	1
R98484	Gasket, Oil Cooler	1

R98485	Gasket, Oil Cooler, Lower	1
R98485	Gasket, Oil Cooler, Lower	1
R98486	Gasket, Oil Cooler	2
R98487	Gasket, Oil Cooler, Lower	1
R98488	Gasket, Oil Filter Adapter	1
R98489	Gasket, Oil Cooler to Cyl	1
R98834	Gasket, Oil Cooler to Cyl	1
T13213	Washer, Oil Drain Plug	1
T20273	Gasket, Timing Gear Cover	1
T20328	Gasket, Oil Filler Cap	1
T23132	Gasket, Water Inlet	1
U13639	O-Ring, Coolant Heater Plug	1

Rod Bolts

Part No.	Description	Qty.	Note
QR74194	Rod Bolt	12	For Con Rods Marked: R51727, R58979 (54mm Long)
QR80033	Rod Bolt Long	12	For Con Rods Marked: R80032, R80034, R113612 (59mm Long)

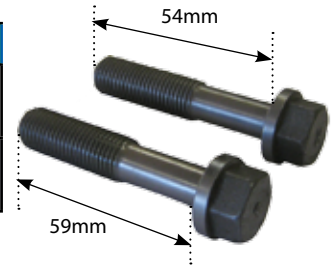

Gaskets

Gaskets			
	Part No.	Description	Qty.
1	QRE38851*	Head Set	1
2	QRP341**	Oil Pan Set	1
3	QRP682***	Conversion Set	1

59242 Sump Set

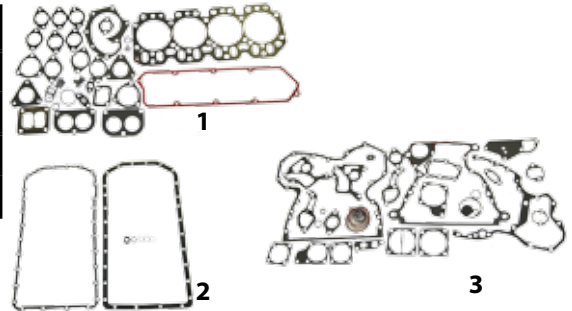

Valve Kit

Valve Kit 59237 Contains			
	Part No.	Description	Qty.
1	QR79623	Valve, Intake	4
2	QR79624	Valve, Exhaust	4
3	QR51734	Valve Seat, Exhaust	4
4	QRP223	Valve Seat, Intake	4
5	QR41412	Retainer, Valve Spring, Intake & Exhaust	8
6	QRE11410	Rotator, Intake & Exhaust	8
7	QR26125	Spring, Valve, Intake & Exhaust	8
8	QT20077	Lock, Valve, Intake & Exhaust	16
9	QT20129	Cap, Valve Stem	8
10	QR87627	O-Ring, Valve Stem	8



Ring Sets, Con Rods & Balancer Shafts

	Part No.	Description
1	QRE66820	Ring Sets
2	QRE21076	Con Rod
3	QAR61351	Balancer Shaft Right
4	QAR61352	Balancer Shaft Left

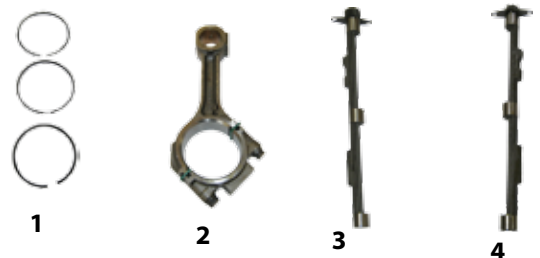

Camshaft, Tappet & Oil Cooler

	Part No.	Description
1	QR82820	Camshaft
2	QT20073	Tappet (8)
3	QRE31929	Oil Cooler



4-239T Turbo Engine

300 Series 239 inches 4 Cylinders

Engine Overhaul Kits

	Part No.	Description	91500 Standard	91510 .010"	91520 .020"
1	QRE33115	Cylinder Kit	4	4	4
1A	QAR65507	O Ring Kit	4	4	4
2	QRE501579	Gasket Set* Contains: Head Set QRE38851 Oil Pan Set QRP341 Conversion Set QRP682	1	1	1
3	QAR67942	Seal Front	1	1	1
4	QR78598	Thrust Washer for Flange-less Bearing	4	4	4
5	QR57160	Balance Bush	6	6	6
6	QR57451	Rod Bush	4	4	4
7	QRE44574	Seal Rear	1	1	1
8	QAR81786	Thrust Bearing STD	1		
	QAR81788	Thrust Bearing 10 Thou		1	
	QAR81789	Thrust Bearing 20 Thou			1
9	QRE27348	Rod Bearing STD	4		
	QRE27349	Rod Bearing 10 Thou		1	
	QRE27358	Rod Bearing 20 Thou			1
10	QRE27352	Main Bearing STD	4		
	QRE27353	Main Bearing 10 Thou		1	
	QRE27360	Main Bearing 20 Thou			1

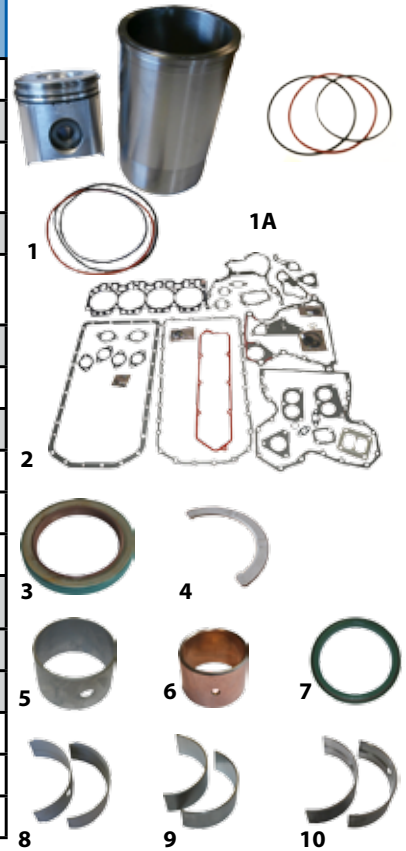

*Gasket Set

Head Set QRE38851 Contains			Conversion Set QRP682 Contains					
R73521-B	Gasket, Rocker Cover, 4 Cyl	1	A4730R	O-Ring, Oil Pump Intake	1	R98485	Gasket, Oil Cooler, Lower	1
R97354-B	Gasket, Inj Pump Mount	1	R116025	Gasket, Water Pump Mount	1	R98486	Gasket, Oil Cooler	2
R105346-B	Gasket, Turbo Oil Outlet	1	R495R	O-Ring, Ventilator Tube	1	R98487	Gasket, Oil Cooler, Lower	1
R97348-B	Gasket, Turbo Oil Inlet	1	R52811	O-Ring, Inlet, Outlet	1	R98488	Gasket, Oil Filter Adapter	1
R89879-B	Gasket, Turbo Mount	1	R56192	O-Ring, Oil Cooler, Inner	1	R98489	Gasket, Oil Cooler to Cyl	1
R56463-B	O-Ring, Vent Tube Outlet	1	R56193	O-Ring, Oil Cooler, Outer	1	R98834	Gasket, Oil Cooler to Cyl	1
R54641-B	Gasket, Thermostat to Cyl Head	1	R56461	O-Ring, Thermostat/Water Tube	1	T13213	Washer, Oil Drain Plug	1
R54638-B	Gasket, Thermostat Cover, Dual	1	R56814	O-Ring, Oil Cooler to Housing	1	T20273	Gasket, Timing Gear Cover	1
R48000	Seal, Pencil Injector	4	R56815	O-Ring, Oil Cooler to Cooler	1	T20328	Gasket, Oil Filler Cap	1
R90658	Gasket, Exhaust Manifold	4	R61871	O-Ring	1	T23132	Gasket, Water Inlet	1
R87627	O-Ring, Valve Stem	8	R70956	Packing, Oil Cooler	1	U13639	O-Ring, Coolant Heater Plug	1
R81275	Gasket, Air Inlet	1	R74354	O-Ring	1			
R60746	Seal, Pencil Injector	4	R75892	O-Ring, Oil Supply Tube	1			
T20219	Gasket, Thermostat Housing	1	R77052	O-Ring	2			
PM-771	Bag, 6X8 Plain, Sharp	1	R79551	Gasket, Oil Cooler Cover	1			
NT20215	Gasket, Thermostat Cover	1	R90648	Gasket, Block to End Plate	1			
R125863-B	Gasket, Cyl Head, 4 Cyl,	1	R97346	Gasket, Water Line	1			
Oil Pan Set QRP341 Contains			R97350	Gasket, Fuel Transfer Pump	1			
R74354	O-Ring	1	R97351	Gasket, Flywheel Housing	1			
R75892	O-Ring, Oil Supply Tube	1	R97352	Gasket, Oil Filler Inlet	1			
R77052	O-Ring	2	R97454	Gasket, Timing Gear Cover	1			
R79563	Sleeve, Rubber	1	R97773	Gasket, Cover	1			
R97342	Gasket, Oil Pan, 4 Cyl,	1	R98484	Gasket, Oil Cooler	1			

Rod Bolts

Part No.	Description	Qty.	Note
QR74194	Rod Bolt	12	For Con Rods Marked: R51727, R58979 (54mm Long)
QR80033	Rod Bolt Long	12	For Con Rods Marked: R80032, R80034, R113612 (59mm Long)

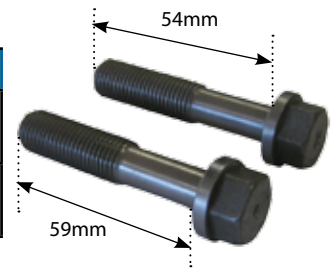

Gaskets

	Part No.	Description	Qty.
1	QRE38851	Head Set	1
2	QRP341	Oil Pan Set	1
3	QRP682	Conversion Set	1
4	QRP341+ QRP682	Sump Set	1

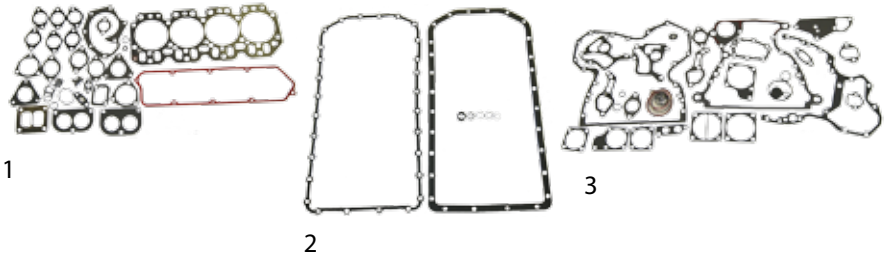

Valve Kit

Valve Kit 59239 Contains

	Part No.	Description	Qty.
1	QR83071	Valve, Intake	4
2	QR79624	Valve, Exhaust	4
3	QR51734	Valve Seal, Exhaust	4
4	QR73064	Valve Seal, Intake	4
5	QR41412	Retainer, Valve Spring, Intake & Exhaust	8
6	QRE11410	Rotator, Intake & Exhaust	8
7	QR26125	Spring, Valve, Intake & Exhaust	8
8	QT20077	Lock, Valve, Intake & Exhaust	16
9	QT20129	Cap, Valve Stem	8
10	QR87627	O-Ring, Valve Stem	8



Ring Sets, Con Rods & Balancer Shafts

	Part No.	Description
1	QRE66820	Ring Sets
2	QRE42733	Con Rod
3	QAR69710	Balancer Shaft Right (746, 398 ->)
4	QAR69711	Balancer Shaft Left (746, 398 ->)
5	QAR61351	Balancer Shaft Right (->746, 397)
6	QAR61352	Balancer Shaft Left (->746, 397)

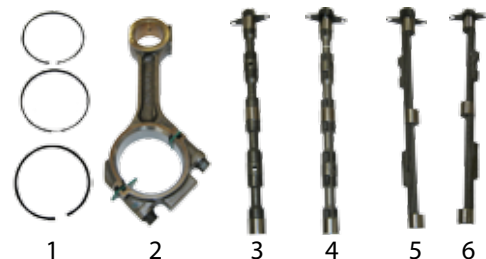

Camshaft, Tappet & Oil Cooler

	Part No.	Description
1	QR82820	Camshaft
2	QT20073	Tappet (8)
3	QRE31929	Oil Cooler



6-359D Engine

300 Series 359 inches 6 Cylinders

Engine Overhaul Kits

	Part No.	Description	93000 Standard Overhaul Kit	93010 .010" Kit	93020 .020" Kit	Bore
1	QRE30250	Cylinder Kit	6	6	6	106.5
1A	QAR65507	O Ring Kit	6	6	6	
2	QRE501580	Gasket Set	1	1	1	
3	QAR67942	Seal Front	1	1	1	
4	QR78598	Thrust Washer for Flange-less Bearing	4	4	4	
5	QR119874	Cam Bush	1	1	1	
6	QR55647	Rod Bush	6	6	6	
7	QRE44574	Seal Rear	1	1	1	
8	QAR81786	Thrust Bearing STD	1			
9	QRE27348	Rod Bearing STD	6			
10	QRE27352	Main Bearing STD	6			
11	QAR81788	Thrust Bearing 10 Thou		1		
12	QRE27349	Rod Bearing 10 Thou		6		
13	QRE27353	Main Bearing 10 Thou		4		
14	QAR81789	Thrust Bearing 20 Thou			1	
15	QRE27358	Rod Bearing 20 Thou			6	
16	QRE27360	Main Bearing 20 Thou			4	

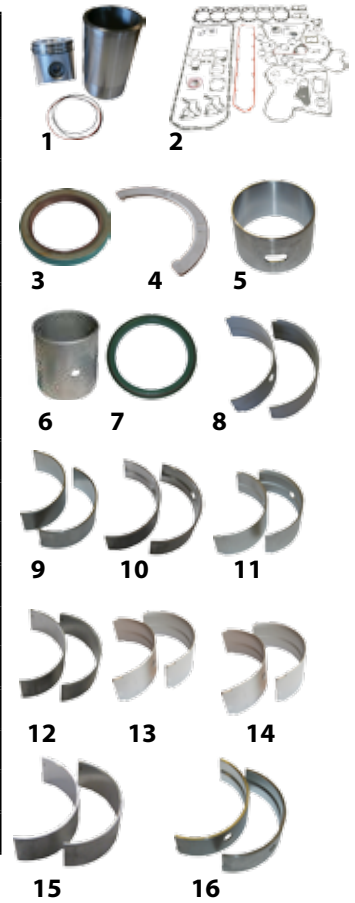

*Head Set QRE38852 Contains		
R114157-B	Gasket, Cyl Head, 6 Cyl,	1
R75728-B	Gasket, Rocker Cover, 6 Cyl	1
T24932	Gasket, Thermostat Cover	1
T23002	Gasket, Water Manifold Outlet	3
R60746	Seal, Pencil Injector	6
R56905	O-Ring, Air Intake	1
R81275	Gasket, Air Inlet	2
R87627	O-Ring, Valve Stem	12
R90658	Gasket, Exhaust Manifold	6
R48000	Seal, Pencil Injector	6
R97354-B	Gasket, Inj Pump Mount	1
R105346-B	Gasket, Turbo Oil Outlet	1
R97348-B	Gasket, Turbo Oil Inlet	1
R89879-B	Gasket, Turbo Mount	1
R56463-B	O-Ring, Vent Tube Outlet	1
R54641-B	Gasket, Thermostat to Cyl Head	1
R54638-B	Gasket, Thermostat Cover, Dual	

Oil Pan Set QRP343

**Conversion Set QRP682 Contains					
A4730R	O-Ring, Oil Pump Intake	1	R98485	Gasket, Oil Cooler, Lower	1
R116025	Gasket, Water Pump Mount	1	R98485	Gasket, Oil Cooler, Lower	1
R495R	O-Ring, Ventilator Tube	1	R98486	Gasket, Oil Cooler	2
R52811	O-Ring, Inlet, Outlet	1	R98487	Gasket, Oil Cooler, Lower	1
R56192	O-Ring, Oil Cooler, Inner	1	R98488	Gasket, Oil Filter Adapter	1
R56193	O-Ring, Oil Cooler, Outer	1	R98489	Gasket, Oil Cooler to Cyl	1
R56461	O-Ring, Thermostat/Water Tube	1	R98834	Gasket, Oil Cooler to Cyl	1
R56814	O-Ring, Oil Cooler to Housing	1	T13213	Washer, Oil Drain Plug	1
R56815	O-Ring, Oil Cooler to Cooler	1	T20273	Gasket, Timing Gear Cover	1
R61871	O-Ring	1	T20328	Gasket, Oil Filler Cap	1
R70956	Packing, Oil Cooler	1	T23132	Gasket, Water Inlet	1
R74354	O-Ring	1	U13639	O-Ring, Coolant Heater Plug	1
R75892	O-Ring, Oil Supply Tube	1			
R77052	O-Ring	2			
R79551	Gasket, Oil Cooler Cover	1			
R90648	Gasket, Block to End Plate	1			
R97346	Gasket, Water Line	1			
R97350	Gasket, Fuel Transfer Pump	1			
R97351	Gasket, Flywheel Housing	1			
R97352	Gasket, Oil Filler Inlet	1			
R97454	Gasket, Timing Gear Cover	1			
R97773	Gasket, Cover	1			
R98484	Gasket, Oil Cooler	1			

Rod Bolts

Part No.	Description	Qty.	Note
QR74194	Rod Bolt	12	For Con Rods Marked: R51727, R58979 (54mm Long)
QR80033	Rod Bolt Long	12	For Con Rods Marked: R80032, R80034, R113612 (59mm Long)

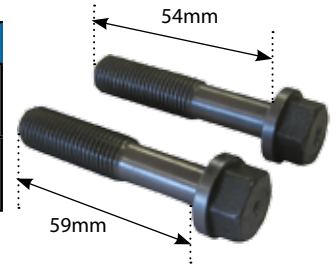

Gaskets

Gaskets			
	Part No.	Description	Qty.
1	QRE38852*	Head Set	1
2	QRP343	Oil Pan Set	1
3	QRP682**	Conversion Set	1

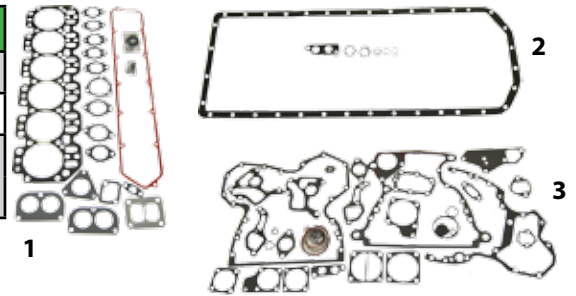

Valve Kit

Valve Kit 59236 Contains			
	Part No.	Description	Qty.
1	QR79623	Valve, Intake	6
2	QR79624	Valve, Exhaust	6
3	QR51734	Valve Seat, Exhaust	6
4	QRP223	Valve Seat, Intake	6
5	QR41412	Retainer, Valve Spring, Intake & Exhaust	12
6	QRE11410	Rotator, Intake & Exhaust	12
7	QR26125	Spring, Valve, Intake & Exhaust	12
8	QT20077	Lock, Valve, Intake & Exhaust	24
9	QT20129	Cap, Valve Stem	12
10	QR87627	O-Ring, Valve Stem	12



Ring Sets, Con Rod

	Part No.	Description
1	QRE66820	Ring Sets
2	QRE21076	Con Rod



Camshaft, Tappet & Oil Cooler

	Part No.	Description
1	QR82821	Camshaft
2	QT20073	Tappet (12)
3	QRE31929	Oil Cooler

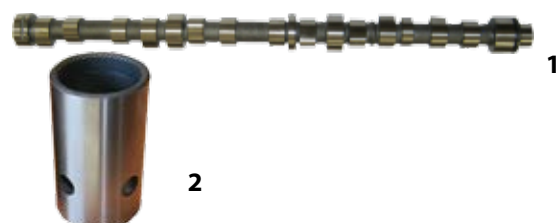

6359T Turbo Engine

300 Series 359 inches 6 Cylinders

Engine Overhaul Kits

	Part No.	Description	91000 Standard Overhaul Kit	91010 .010" Kit	91020 .020" Kit	Bore
1	QRE33115	Cylinder Kit	6	6	6	106.5
1A	QAR65507	O Ring Kit	6	6	6	
2	QRE501580	Gasket Set	1	1	1	
3	QAR67942	Seal Front	1	1	1	
4	QR78598	Thrust Washer for Flange-less Bearing	4	4	4	
5	QR57451	Rod Bush	6	6	6	
6	QRE44574	Seal Rear	1	1	1	
7	QAR81786	Thrust Bearing STD	1			
8	QRE27348	Rod Bearing STD	6			
9	QRE27352	Main Bearing STD	6			
10	QAR81788	Thrust Bearing 10 Thou		1		
11	QRE27349	Rod Bearing 10 Thou		6		
12	QRE27353	Main Bearing 10 Thou		6		
13	QAR81789	Thrust Bearing 20 Thou			1	
14	QRE27358	Rod Bearing 20 Thou			6	
15	QRE27360	Main Bearing 20 Thou			6	

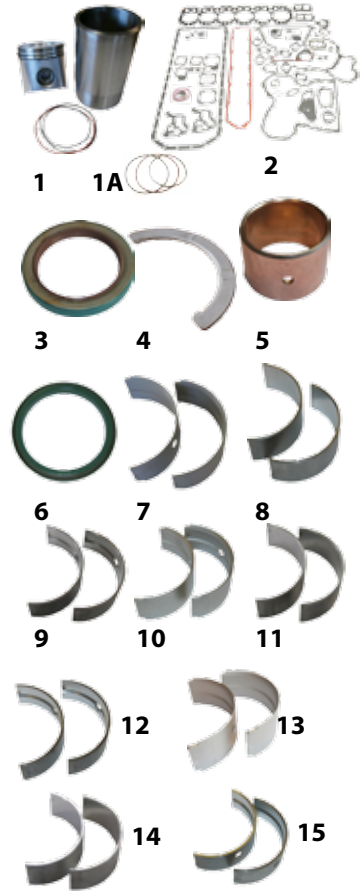

*Head Set QRE38852 Contains			**Conversion Set QRP682 Contains					
R114157-B	Gasket, Cyl Head, 6 Cyl,	1	A4730R	O-Ring, Oil Pump Intake	1	R98485	Gasket, Oil Cooler, Lower	1
R75728-B	Gasket, Rocker Cover, 6 Cyl	1	R116025	Gasket, Water Pump Mount	1	R98485	Gasket, Oil Cooler, Lower	1
T24932	Gasket, Thermostat Cover	1	R495R	O-Ring, Ventilator Tube	1	R98486	Gasket, Oil Cooler	2
T23002	Gasket, Water Manifold Outlet	3	R52811	O-Ring, Inlet, Outlet	1	R98487	Gasket, Oil Cooler, Lower	1
R60746	Seal, Pencil Injector	6	R56192	O-Ring, Oil Cooler, Inner	1	R98488	Gasket, Oil Filter Adapter	1
R56905	O-Ring, Air Intake	1	R56193	O-Ring, Oil Cooler, Outer	1	R98489	Gasket, Oil Cooler to Cyl	1
R81275	Gasket, Air Inlet	2	R56461	O-Ring, Thermostat/Water Tube	1	R98834	Gasket, Oil Cooler to Cyl	1
R87627	O-Ring, Valve Stem	12	R56814	O-Ring, Oil Cooler to Housing	1	T13213	Washer, Oil Drain Plug	1
R90658	Gasket, Exhaust Manifold	6	R56815	O-Ring, Oil Cooler to Cooler	1	T20273	Gasket, Timing Gear Cover	1
R48000	Seal, Pencil Injector	6	R61871	O-Ring	1	T20328	Gasket, Oil Filler Cap	1
R97354-B	Gasket, Inj Pump Mount	1	R70956	Packing, Oil Cooler	1	T23132	Gasket, Water Inlet	1
R105346-B	Gasket, Turbo Oil Outlet	1	R74354	O-Ring	1	U13639	O-Ring, Coolant Heater Plug	1
R97348-B	Gasket, Turbo Oil Inlet	1	R75892	O-Ring, Oil Supply Tube	1			
R89879-B	Gasket, Turbo Mount	1	R77052	O-Ring	2			
R56463-B	O-Ring, Vent Tube Outlet	1	R79551	Gasket, Oil Cooler Cover	1			
R54641-B	Gasket, Thermostat to Cyl Head	1	R90648	Gasket, Block to End Plate	1			
R54638-B	Gasket, Thermostat Cover, Dual		R97346	Gasket, Water Line	1			
			R97350	Gasket, Fuel Transfer Pump	1			
			R97351	Gasket, Flywheel Housing	1			
			R97352	Gasket, Oil Filler Inlet	1			
			R97454	Gasket, Timing Gear Cover	1			
			R97773	Gasket, Cover	1			
			R98484	Gasket, Oil Cooler	1			
Oil Pan Set QRP343								

Rod Bolts

Part No.	Description	Qty.	Note
QR74194	Rod Bolt	12	For Con Rods Marked: R51727, R58979 (54mm Long)
QR80033	Rod Bolt Long	12	For Con Rods Marked: R80032, R80034, R113612 (59mm Long)

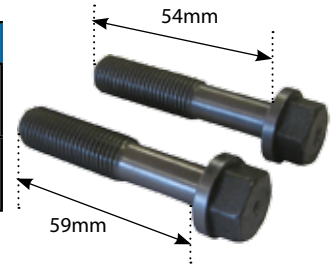

Gaskets

Gaskets			
	Part No.	Description	Qty.
1	QRE38852	Head Set*	1
2	QRP343	Oil Pan Set	1
3	QRP682	Conversion Set**	1
			} Sump Set

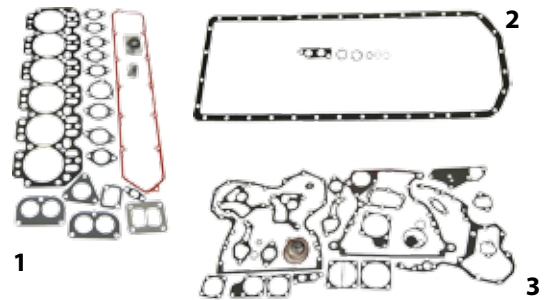

Valve Kit

Valve Kit 59238 Contains			
	Part No.	Description	Qty.
1	QR83071	Valve, Intake	6
2	QR79624	Valve, Exhaust	6
3	QR51734	Valve Seat, Exhaust	6
4	QR73064	Valve Seat, Intake	6
5	QR41412	Retainer, Valve Spring, Intake & Exhaust	12
6	QRE11410	Rotator, Intake & Exhaust	12
7	QR26125	Spring, Valve, Intake & Exhaust	12
8	QT20077	Lock, Valve, Intake & Exhaust	24
9	QT20129	Cap, Valve Stem	12
10	QR87627	O-Ring, Valve Stem	12



Ring Sets, Con Rods

Part No.	Description
1	QRE66820
2	QRE42733



Camshaft, Tappet & Oil Cooler

Part No.	Description
1	QR82821
2	QT20073
3	QRE31929



4039T Turbo Engine

300 Series 3.9 Litres 4 Cylinders

Engine Overhaul Kits

	Part No.	Description	90000 Standard	90010 .010"	90020 .020"
1	QRE33115	Cylinder Kit	4	4	4
1A	QAR65507	O Ring Kit	4	4	4
2	QRE501579	Gasket Set	1	1	1
3	QAR67942	Seal Front	1	1	1
4	QR78598	Thrust Washer for Flange-less Bearing	4	4	4
5	QR57160	Balance Bush	6	6	6
6	QR119874	Cam Bush	1	1	1
7	QR57451	Rod Bush	4	4	4
8	QRE44574	Seal Rear	1	1	1
9	QAR81786	Thrust Bearing STD	1		
10	QRE27348	Rod Bearing STD	4		
11	QRE27352	Main Bearing STD	4		
12	QAR81788	Thrust Bearing 10 Thou		1	
13	QRE27349	Rod Bearing 10 Thou		4	
14	QRE27353	Main Bearing 10 Thou		4	
15	QAR81789	Thrust Bearing 20 Thou			1
16	QRE27358	Rod Bearing 20 Thou			4
17	QRE27360	Main Bearing 20 Thou			4



* Head Set QRE38851 Contains		
R73521-B	Gasket, Rocker Cover, 4 Cyl	1
R97354-B	Gasket, Inj Pump Mount	1
R105346-B	Gasket, Turbo Oil Outlet	1
R97348-B	Gasket, Turbo Oil Inlet	1
R89879-B	Gasket, Turbo Mount	1
R56463-B	O-Ring, Vent Tube Outlet	1
R54641-B	Gasket, Thermostat to Cyl Head	1
R54638-B	Gasket, Thermostat Cover, Dual	1
R48000	Seal, Pencil Injector	4
R90658	Gasket, Exhaust Manifold	4
R87627	O-Ring, Valve Stem	8
R81275	Gasket, Air Inlet	1
R60746	Seal, Pencil Injector	4
T20219	Gasket, Thermostat Housing	1
PM-771	Bag, 6X8 Plain, Sharp	1
NT20215	Gasket, Thermostat Cover	1
R125863-B	Gasket, Cyl Head, 4 Cyl,	1
**Oil Pan Set QRP341 Contains		
R74354	O-Ring	1
R75892	O-Ring, Oil Supply Tube	1
R77052	O-Ring	2
R79563	Sleeve, Rubber	1
R97342	Gasket, Oil Pan, 4 Cyl,	1

*** Conversion Set QRP682 Contains					
A4730R	O-Ring, Oil Pump Intake	1	R98485	Gasket, Oil Cooler, Lower	1
R116025	Gasket, Water Pump Mount	1	R98485	Gasket, Oil Cooler, Lower	1
R495R	O-Ring, Ventilator Tube	1	R98486	Gasket, Oil Cooler	2
R52811	O-Ring, Inlet, Outlet	1	R98487	Gasket, Oil Cooler, Lower	1
R56192	O-Ring, Oil Cooler, Inner	1	R98488	Gasket, Oil Filter Adapter	1
R56193	O-Ring, Oil Cooler, Outer	1	R98489	Gasket, Oil Cooler to Cyl	1
R56461	O-Ring, Thermostat/Water Tube	1	R98834	Gasket, Oil Cooler to Cyl	1
R56814	O-Ring, Oil Cooler to Housing	1	T13213	Washer, Oil Drain Plug	1
R56815	O-Ring, Oil Cooler to Cooler	1	T20273	Gasket, Timing Gear Cover	1
R61871	O-Ring	1	T20328	Gasket, Oil Filler Cap	1
R70956	Packing, Oil Cooler	1	T23132	Gasket, Water Inlet	1
R74354	O-Ring	1	U13639	O-Ring, Coolant Heater Plug	1
R75892	O-Ring, Oil Supply Tube	1			
R77052	O-Ring	2			
R79551	Gasket, Oil Cooler Cover	1			
R90648	Gasket, Block to End Plate	1			
R97346	Gasket, Water Line	1			
R97350	Gasket, Fuel Transfer Pump	1			
R97351	Gasket, Flywheel Housing	1			
R97352	Gasket, Oil Filler Inlet	1			
R97454	Gasket, Timing Gear Cover	1			
R97773	Gasket, Cover	1			
R98484	Gasket, Oil Cooler	1			

Rod Bolts

Part No.	Description	Qty.	Note
QR80033	Rod Bolt Long	8	For Con Rods Marked: R80032, R80034, R113612 (59mm Long)



Gaskets

Gaskets			
	Part No.	Description	Qty.
1	QRE38851	Head Set*	1
2	QRP341	Oil Pan Set**	1
3	QRP682	Conversion Set***	1

59242 Sump Set

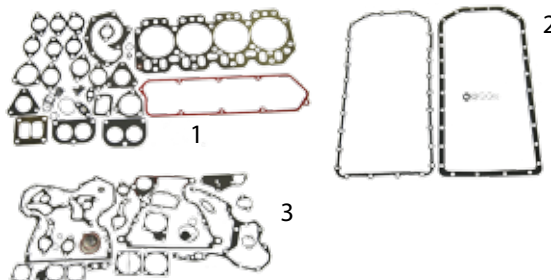

Valve Kit

Valve Kit 59240 Contains			
	Part No.	Description	Qty.
1	QR98062	Valve, Intake	4
2	QR90692	Valve, Exhaust	4
3	QR85687	Valve Seat, Exhaust	4
4	QR98063	Valve Seat, Intake	4
5	QRE60005	Rotator, Intake & Exhaust	8
6	QR26125	Spring, Valve, Intake & Exhaust	8
7	QR91889	Lock, Valve, Intake & Exhaust	16
8	QRE31617	Cap, Valve Stem	8



Ring Sets, Con Rods & Balancer Shafts

Part No.	Description
1	QRE66820
2	QRE42733

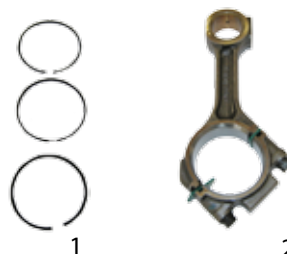

Camshaft, Tappet & Oil Cooler

Part No.	Description
1	QR82820
2	QT20073
3	QRE31929



4045T Turbo Engine

300 Series 4.5 Litres 4 Cylinders

Engine Overhaul Kits

	Part No.	Description	94000 Standard Overhaul Kit	94010 .010" Kit	94020 .020" Kit
1	QRE53073	Cylinder Kit Bore=106.5	4	4	4
1A	QAR65507	O Ring Kit	4	4	4
2	QRE501568	Gasket Set*	1	1	1
3	QAR67942	Seal Front	1	1	1
4	QR78598	Thrust Washer for Flange-less Bearing	4	4	4
5	QR57160	Balance Bush	6	6	6
6	QR57451	Rod Bush	4	4	4
7	QRE44574	Seal Rear	1	1	1
8	QAR81786	Thrust Bearing STD	1		
9	QAR97517	Rod Bearing STD	4		
10	QRE27352	Main Bearing STD	4		
11	QAR81788	Thrust Bearing 10 Thou		1	
12	QAR97653	Rod Bearing 10 Thou		4	
13	QRE27353	Main Bearing 10 Thou		4	
14	QAR81789	Thrust Bearing 20 Thou			1
15	QAR97654	Rod Bearing 20 Thou			4
16	QRE27360	Main Bearing 20 Thou			4



*Gasket Set

Head Set QRE501568 Contains		
R97354-B	Gasket, Inj Pump Mount	1.
R105346-B	Gasket, Turbo Oil Outlet	1.
R97348-B	Gasket, Turbo Oil Inlet	1.
R89879-B	Gasket, Turbo Mount	1.
R56463-B	O-Ring, Vent Tube Outlet	1.
R54641-B	Gasket, Thermostat to Cyl Head	1.
R54638-B	Gasket, Thermostat Cover, Dual	1.
R79551-B	Gasket, Oil Cooler Cover	1.
R77052-B	O-Ring	2.
R61871-B	O-Ring	1.
R56815-B	O-Ring, Oil Cooler to Cooler	1.
R56814-B	O-Ring, Oil Cooler to Housing	1.
R56193-B	O-Ring, Oil Cooler, Outer	1.
R56192-B	O-Ring, Oil Cooler, Inner	1.
U13639-B	O-Ring, Coolant Heater Plug	1.
R98834-B	Gasket, Oil Cooler to Cyl	1.
R98489-B	Gasket, Oil Cooler to Cyl	1.
R98488-B	Gasket, Oil Filter Adapter	1.
R98487-B	Gasket, Oil Cooler, Lower	1.
R98486-B	Gasket, Oil Cooler	2.
R98485-B	Gasket, Oil Cooler, Lower	1.
R98484-B	Gasket, Oil Cooler	1.

A4730R-B	O-Ring, Oil Pump Intake	1.
R48000	Seal, Pencil Injector	4.
R90658	Gasket, Exhaust Manifold	4.
R87627	O-Ring, Valve Stem	8.
R81275	Gasket, Air Inlet	1.
R60746	Seal, Pencil Injector	4.
T20219	Gasket, Thermostat Housing	1.
T20215	Gasket, Thermostat Cover	1.
R56461	O-Ring, Thermostat/Water Tube	1.
R97773	Gasket, Cover	1.
T20328	Gasket, Oil Filler Cap	1.
T20273	Gasket, Timing Gear Cover	1.
R97454	Gasket, Timing Gear Cover	1.
NT13213	Washer, Oil Drain Plug	1.
R97351	Gasket, Flywheel Housing	1.
R90648	Gasket, Block to End Plate	1.
R116025	Gasket, Water Pump Mount	1.
R70956	Packing, Oil Cooler	1.
R74354	O-Ring	1.
R75892	O-Ring, Oil Supply Tube	1.
R97350	Gasket, Fuel Transfer Pump	1.
R97352	Gasket, Oil Filler Inlet	1.
R73521-B	Gasket, Rocker Cover, 4 Cyl	1.

R97342-B	Gasket, Oil Pan, 4 Cyl,	1.
R79563-B	Sleeve, Rubber	1.
R77052-B	O-Ring	2.
R75892-B	O-Ring, Oil Supply Tube	1.
R74354-B	O-Ring	1.
R132256	Gasket, Oil Filler Housing	1.
R26286	O-Ring, Fuel Line	1.
R79563	Sleeve, Rubber	1.
R61871	O-Ring	1.
R56461	O-Ring, Thermostat/Water Tube	1.
T20304	O-Ring	1.
R125863-B	Gasket, Cyl Head, 4 Cyl,	1.

Rod Bolts

Part No.	Description	Qty.
QR74195	Rod Bolt 4045T 6068T 300 Series (64mm Long)	8



Gaskets

Gaskets			
	Part No.	Description	Qty.
1	QRE38851	Head Set	1
2	QRP341	Oil Pan Set	1

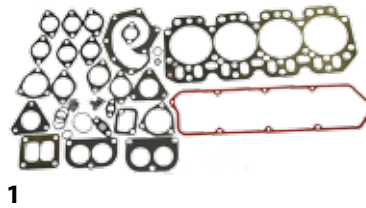

1



2

Valve Kit

Valve Kit 59236 Contains			
	Part No.	Description	Qty.
1	QR98062	Valve, Intake	4
2	QR90692	Valve, Exhaust	4
3	QR85687	Valve Seat, Exhaust	4
4	QR98063	Valve Seat, Intake	4
5	QRE60005	Rotator, Intake & Exhaust	8
6	QR26125	Spring, Valve, Intake & Exhaust	8
7	QR91889	Lock, Valve, Intake & Exhaust	16
8	QRE31617	Cap, Valve Stem	8



Ring Sets, Con Rod

	Part No.	Description
1	QRE66820	Ring Sets
2	QAR69710	Balancer Shaft Right
3	QAR69711	Balancer Shaft Left



Camshaft, Tappet

	Part No.	Description
1	QR82820	Camshaft
2	QT20073	Tappet (8)



6059D Engine Type

300 Series 5.9 Litres 6 Cylinders



RELIANCE

	Part No.	Description	10000 Standard Overhaul Kit	10010 .010" Kit	10020 .020" Kit	Bore
1	QRE30250	Cylinder Kit	6	6	6	106.5
1A	QAR65507	O Ring Kit	6	6	6	
2	QRE501580	Gasket Set*	1	1	1	
3	QAR67942	Seal Front	1	1	1	
4	QAR81786	Thrust Bearing Pair	1			
5	QAR81786	Thrust Bearing 10 Thou		1		
6	QAR81789	Thrust Bearing 20 Thou			1	
7	QR78598	Thrust Washer for Flangeless Bearing	4	4	4	
8	QR55647	Rod Bush	6	6	6	
9	QR80033	Rod Bolt LONG	12	12	12	
10	QRE44574	Seal Rear	1	1	1	
11	QRE27348	Rod Bearing STD	6			
12	QRE27349	Rod Bearing 10 Thou		6		
13	QRE27358	Rod Bearing 20 Thou			6	
14	QRE27352	Main Bearing STD	6			
15	QRE27353	Main Bearing 10 Thou		6		
16	QRE27360	Main Bearing 20 Thou			6	



*Gasket Set

Head Set QRE501580 Contains		
R114157-B	Gasket, Cyl Head, 6 Cyl,	1
T24932	Gasket, Thermostat Cover	1
NT23002	Gasket, Water Manifold Outlet	3
R60746	Seal, Pencil Injector	6
R56905	O-Ring, Air Intake	1
R81275	Gasket, Air Inlet	2
R87627	O-Ring, Valve Stem	12
R90658	Gasket, Exhaust Manifold	6
NR48000	Seal, Pencil Injector	6
R97354-B	Gasket, Inj Pump Mount	1
R105346-B	Gasket, Turbo Oil Outlet	1
R97348-B	Gasket, Turbo Oil Inlet	1
R89879-B	Gasket, Turbo Mount	1
R56463-B	O-Ring, Vent Tube Outlet	1
R54641-B	Gasket, Thermostat to Cyl Head	1
R54638-B	Gasket, Thermostat Cover, Dual	1
R56461	O-Ring, Thermostat/Water Tube	1
R97773	Gasket, Cover	1
T20328	Gasket, Oil Filler Cap	1
T20273	Gasket, Timing Gear Cover	1
R97454	Gasket, Timing Gear Cover	1
T13213	Washer, Oil Drain Plug	1
R97351	Gasket, Flywheel Housing	1

R90648	Gasket, Block to End Plate	1
R116025	Gasket, Water Pump Mount	1
R70956	Packing, Oil Cooler	1
R74354	O-Ring	1
R75892	O-Ring, Oil Supply Tube	1
R97350	Gasket, Fuel Transfer Pump	1
R97352	Gasket, Oil Filler Inlet	1
R75728-B	Gasket, Rocker Cover, 6 Cyl	1
R79551-B	Gasket, Oil Cooler Cover	1
R77052-B	O-Ring	2
R61871-B	O-Ring	1
R56815-B	O-Ring, Oil Cooler to Cooler	1
R56814-B	O-Ring, Oil Cooler to Housing	1
R56193-B	O-Ring, Oil Cooler, Outer	1
R56192-B	O-Ring, Oil Cooler, Inner	1
U13639-B	O-Ring, Coolant Heater Plug	1
R98834-B	Gasket, Oil Cooler to Cyl	1
R98489-B	Gasket, Oil Cooler to Cyl	1
R98488-B	Gasket, Oil Filter Adapter	1
R98487-B	Gasket, Oil Cooler, Lower	1
R98486-B	Gasket, Oil Cooler	2
R98485-B	Gasket, Oil Cooler, Lower	1
R98484-B	Gasket, Oil Cooler	1

NR90648	Gasket, Block to End Plate	1
A4730R-B	O-Ring, Oil Pump Intake	1
R26286-B	O-Ring, Fuel Line	1
R97354-B	Gasket, Inj Pump Mount	1
R61871-B	O-Ring	1
R56461-B	O-Ring, Thermostat/Water Tube	1
T23132-B	Gasket, Water Inlet	1
R116025-B	Gasket, Water Pump Mount	1
T20304-B	O-Ring	1
R98488	Gasket, Oil Filter Adapter	1
R77052	O-Ring	2
R74354	O-Ring	1
R61871	O-Ring	2
R97344	Subs to RP343	1

6059T Engine Type

300 Series 5.9 Litres 6 Cylinders



RELIANCE

	Part No.	Description	10030 Standard Overhaul Kit	10040 .010" Kit	10050 .020" Kit	Bore
1	QRE33115	Cylinder Kit	6	6	6	106.5
1A	QAR65507	O Ring Kit	6	6	6	
2	QRE501580	Gasket Set*	1	1	1	
3	QAR67942	Seal Front	1	1	1	
4	QAR81786	Thrust Bearing Pair	1			
5	QAR81788	Thrust Bearing 10 Thou		1		
6	QAR81789	Thrust Bearing 20 Thou			1	
7	QR78598	Thrust Washer for Flangeless Bearing	4	4	4	
8	QR57451	Rod Bush	6	6	6	
9	QR80033	Rod Bolt LONG	12	12	12	
10	QRE44574	Seal Rear	1	1	1	
11	QRE27348	Rod Bearing STD	6			
12	QRE27349	Rod Bearing 10 Thou		6		
13	QRE27358	Rod Bearing 20 Thou			6	
14	QRE27352	Main Bearing STD	6			
15	QRE27353	Main Bearing 10 Thou		6		
16	QRE27360	Main Bearing 20 Thou			6	



*Gasket Set

Head Set QRE501580 Contains		
R114157-B	Gasket, Cyl Head, 6 Cyl,	1
T24932	Gasket, Thermostat Cover	1
T23002	Gasket, Water Manifold Outlet	3
R60746	Seal, Pencil Injector	6
R56905	O-Ring, Air Intake	1
R81275	Gasket, Air Inlet	2
R87627	O-Ring, Valve Stem	12
R90658	Gasket, Exhaust Manifold	6
R48000	Seal, Pencil Injector	6
R97354-B	Gasket, Inj Pump Mount	1
R105346-B	Gasket, Turbo Oil Outlet	1
R97348-B	Gasket, Turbo Oil Inlet	1
R89879-B	Gasket, Turbo Mount	1
R56463-B	O-Ring, Vent Tube Outlet	1
R54641-B	Gasket, Thermostat to Cyl Head	1
R54638-B	Gasket, Thermostat Cover, Dual	1
R56461	O-Ring, Thermostat/Water Tube	1
R97773	Gasket, Cover	1
T20328	Gasket, Oil Filler Cap	1
T20273	Gasket, Timing Gear Cover	1
R97454	Gasket, Timing Gear Cover	1

T13213	Washer, Oil Drain Plug	1
R97351	Gasket, Flywheel Housing	1
R90648	Gasket, Block to End Plate	1
R116025	Gasket, Water Pump Mount	1
R70956	Packing, Oil Cooler	1
R74354	O-Ring	1
R75892	O-Ring, Oil Supply Tube	1
R97350	Gasket, Fuel Transfer Pump	1
R97352	Gasket, Oil Filler Inlet	1
R75728-B	Gasket, Rocker Cover, 6 Cyl	1
R79551-B	Gasket, Oil Cooler Cover	1
R77052-B	O-Ring	2
R61871-B	O-Ring	1
R56815-B	O-Ring, Oil Cooler to Cooler	1
R56814-B	O-Ring, Oil Cooler to Housing	1
R56193-B	O-Ring, Oil Cooler, Outer	1
R56192-B	O-Ring, Oil Cooler, Inner	1
U13639-B	O-Ring, Coolant Heater Plug	1
R98834-B	Gasket, Oil Cooler to Cyl	1
R98489-B	Gasket, Oil Cooler to Cyl	1
R98488-B	Gasket, Oil Filter Adapter	1

R98487-B	Gasket, Oil Cooler, Lower	1
R98486-B	Gasket, Oil Cooler	2
R98485-B	Gasket, Oil Cooler, Lower	1
R98484-B	Gasket, Oil Cooler	1
R90648	Gasket, Block to End Plate	1
A4730R-B	O-Ring, Oil Pump Intake	1
R26286-B	O-Ring, Fuel Line	1
NR97354-B	Gasket, Inj Pump Mount	1
R61871-B	O-Ring	1
R56461-B	O-Ring, Thermostat/Water Tube	1
T23132-B	Gasket, Water Inlet	1
R116025-B	Gasket, Water Pump Mount	1
T20304-B	O-Ring	1
R98488	Gasket, Oil Filter Adapter	1
R77052	O-Ring	2
R74354	O-Ring	1
R61871	O-Ring	2
R97344	Subs to RP343	1

6068T Turbo Engine

300 Series 6.8 Litres 6 Cylinders

Engine Overhaul Kits

	Part No.	Description	95000 Standard Overhaul Kit	95010 .010" Kit	95020 .020" Kit
1	QRE53073	Cylinder Kit Bore 106.5	6	6	6
1A	QAR65507	O Ring Kit	6	6	6
2	QRE501569	Gasket Set*	1	1	1
3	QAR67942	Seal Front	1	1	1
4	QR78598	Thrust Washer for Flange-less Bearing	4	4	4
5	QR57451	Rod Bush	6	6	6
6	QRE44574	Seal Rear	1	1	1
7	QAR81786	Thrust Bearing STD	1		
8	QAR97517	Rod Bearing STD	6		
9	QRE27352	Main Bearing STD	6		
10	QAR81788	Thrust Bearing 10 Thou		1	
11	QAR97653	Rod Bearing 10 Thou		6	
12	QRE27353	Main Bearing 10 Thou		6	
13	QAR81789	Thrust Bearing 20 Thou			1
14	QAR97654	Rod Bearing 20 Thou			6
15	QRE27360	Main Bearing 20 Thou			6

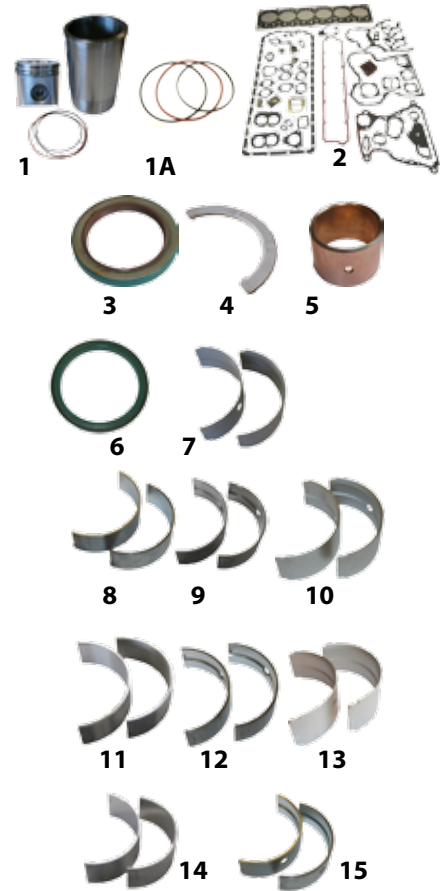

*Gasket Set

Head Set QRE501569 Contains		
R114157-B	Gasket, Cyl Head, 6 Cyl,	1.
T24932	Gasket, Thermostat Cover	1.
T23002	Gasket, Water Manifold Outlet	3.
R60746	Seal, Pencil Injector	6.
R56905	O-Ring, Air Intake	1.
R81275	Gasket, Air Inlet	2.
R87627	O-Ring, Valve Stem	12.
R90658	Gasket, Exhaust Manifold	6.
R48000	Seal, Pencil Injector	6.
R97354-B	Gasket, Inj Pump Mount	1.
R105346-B	Gasket, Turbo Oil Outlet	1.
R97348-B	Gasket, Turbo Oil Inlet	1.
R89879-B	Gasket, Turbo Mount	1.
R56463-B	O-Ring, Vent Tube Outlet	1.
R54641-B	Gasket, Thermostat to Cyl Head	1.
R54638-B	Gasket, Thermostat Cover, Dual	1.
R79551-B	Gasket, Oil Cooler Cover	1.
R77052-B	O-Ring	2.
R61871-B	O-Ring	1.
R56815-B	O-Ring, Oil Cooler to Cooler	1.
R56814-B	O-Ring, Oil Cooler to Housing	1.
R56193-B	O-Ring, Oil Cooler, Outer	1.
R56192-B	O-Ring, Oil Cooler, Inner	1.
U13639-B	O-Ring, Coolant Heater Plug	1.
R98834-B	Gasket, Oil Cooler to Cyl	1.

R98489-B	Gasket, Oil Cooler to Cyl	1.
R98488-B	Gasket, Oil Filter Adapter	1.
R98487-B	Gasket, Oil Cooler, Lower	1.
R98486-B	Gasket, Oil Cooler	2.
R98485-B	Gasket, Oil Cooler, Lower	1.
R98484-B	Gasket, Oil Cooler	1.
A4730R-B	O-Ring, Oil Pump Intake	1.
R56461	O-Ring, Thermostat/Water Tube	1.
R97773	Gasket, Cover	1.
T20328	Gasket, Oil Filler Cap	1.
T20273	Gasket, Timing Gear Cover	1.
R97454	Gasket, Timing Gear Cover	1.
T13213	Washer, Oil Drain Plug	1.
T13213-B	Washer, Oil Drain Plug	1.
R97351	Gasket, Flywheel Housing	1.
R90648	Gasket, Block to End Plate	1.
R116025	Gasket, Water Pump Mount	1.
R70956	Packing, Oil Cooler	1.
R74354	O-Ring	1.
R75892	O-Ring, Oil Supply Tube	1.
R97350	Gasket, Fuel Transfer Pump	1.
R97352	Gasket, Oil Filler Inlet	1.
R75728-B	Gasket, Rocker Cover, 6 Cyl	1.
R98488	Gasket, Oil Filter Adapter	1.
R77052	O-Ring	2.
R74354	O-Ring	1.

R61871	O-Ring	2.
R97344	Subs to RP343	1.
R97346	Gasket, Water Line	1.
R52811	O-Ring, Inlet, Outlet	2.
T23132	Gasket, Water Inlet	1.
R132256	Gasket, Oil Filler Housing	1.
R26286	O-Ring, Fuel Line	1.
R79563	Sleeve, Rubber	1.
R61871	O-Ring	1.
R56461	O-Ring, Thermostat/Water Tube	1.
T20304	O-Ring	1.

Rod Bolts

Part No.	Description	Qty.
QR74195	Rod Bolt 4045T 6068T 300 Series (64mm Long)	12



Gaskets

Gaskets			
	Part No.	Description	Qty.
1	QRE38852	Head Set	1
2	QRP343	Oil Pan Set	1
3	QRP682	Conversion Set	1

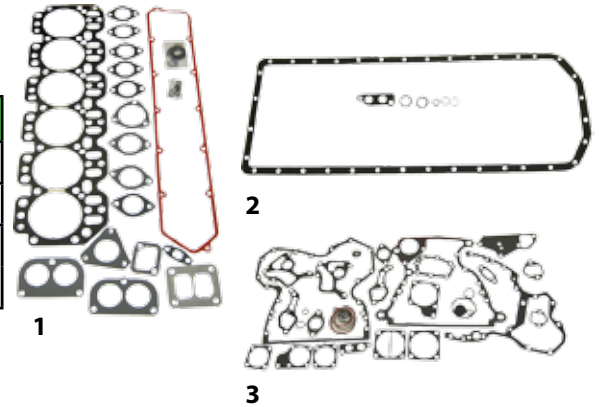

Valve Kit

Valve Kit 59235 Contains			
	Part No.	Description	Qty.
1	QR98062	Valve, Intake	6
2	QR90692	Valve, Exhaust	6
3	QR85687	Valve Seat, Exhaust	6
4	QR98063	Valve Seat, Intake	6
5	QRE60005	Rotator, Intake & Exhaust	12
6	QR26125	Spring, Valve, Intake & Exhaust	12
7	QR91889	Lock, Valve, Intake & Exhaust	24
8	QRE31617	Cap, Valve Stem	12



Ring Sets

Part No.	Description
1	QRE66820



Camshaft, Tappet

Part No.	Description
1	QR82821
2	QT20073



4045D 4.5 Powertech®

350 Series 4.5 Litres 4 Cylinders

	Part No.	Description	96000 Standard Overhaul Kit	96010 .010" Kit
1	QRE505110	Cylinder Kit* Bore106.5	4	4
1A	QAR65507	O Ring Kit	4	4
2	QRE501455	Gasket Set*	1	1
3	QR115299	Balance Bush	6	6
4	QR119874	Cam Bush	1	1
5	QR123960	Rod Bush	4	4
6	QRE65168	Thrust Bearing STD	1	
7	QRE65908	Rod Bearing STD	4	
8	QRE65165	Main Bearing STD	4	
9	QRE65912	Thrust Bearing 10 Thou		1
10	QRE65909	Rod Bearing 10 Thou		4
11	QRE65911	Main Bearing 10 Thou		4



*Gasket Set

Gasket Set QRE501455 Contains		
R116515-B	Gasket, Cyl Head, 4.5 PT	1
RE516340	Seal, Crankshaft, Front	1
RE44574	SEAL,CRANKSHAFT,REAR	1
R92097-B	Gasket, Turbo Mount	1
R123226-B	Seal, Water Bypass Tube	2
R90658-B	Gasket, Exhaust Manifold	4
R123570-B	Gasket, Turbo Oil Drain	1
R54638-B	Gasket, Thermostat Cover, Dual	1
R123345-B	Gasket, Tstat Housing	1
R121416-B	Gasket, Water Pump To Head	1
R81275-B	Gasket, Air Inlet	2
R123575-B	O-Ring	4
R503891-B	Gasket, Turbo Oil Drain	1
R136516-B	Gasket, Timing Cover	1
R136515-B	Gasket, Timing Cover	1
R520131-B	Gasket, Timing Cover	1

R520132-B	Gasket, Timing Cover	1
A4827R-B	Washer, Special Aluminum	1
R123501-B	Gasket, Oil Cooler Housing	1
R502864-B	Gasket, Remote OF Adapter	1
R53108-B	Gasket, Starter to Block	1
R72328-B	O-Ring, Turbo Return/Water	4
R123273-B	O-Ring, Fuel Pump	1
R89944-B	O-Ring, Injector Pump Mount	1
R61105-B	O-Ring, Tube to Timing Cover	2
T122075-B	O-Ring	2
R500374-B	Gasket, Oil Filter Header	1
R123525-B	Gasket, Oil Filter Header	1
R501428-B	Gasket, Coolant Passage	1
R123417-B	Gasket, Water Pump	1
R502902-B	Packing, Oil Fill Cap	1
R136495-B	Gasket, Oil Fill Cover	3

Rod Bolts

Part No.	Description	Qty.	Note
QR114083	Rod Bolt	8	For Con Rods Marked: R123959 (64mm Long)
QR501124	Rod Bolt Long	8	For Con Rods Marked: R500000 (61mm Long)

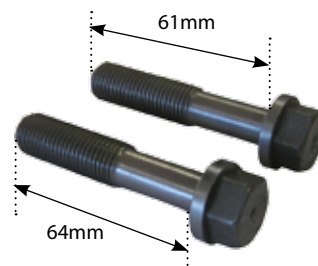

Gaskets

Gaskets			
	Part No.	Description	Qty.
1	QRE66082	Head Set	1
2	QRP793	Sump Set	1

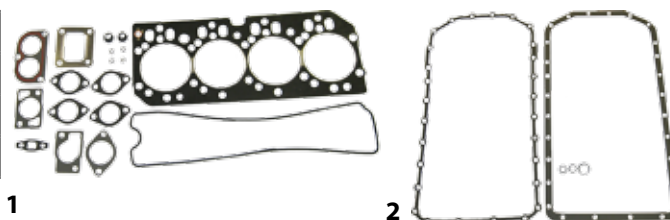

Valve Kit

Valve Kit 59240 Contains			
	Part No.	Description	Qty.
1	QR98062	Valve, Intake	4
2	QR90692	Valve, Exhaust	4
3	QR85687	Valve Seat, Exhaust	4
4	QR98063	Valve Seat, Intake	4
5	QRE60005	Rotator, Intake & Exhaust	8
6	QR26125	Spring, Valve, Intake & Exhaust	8
7	QR91889	Lock, Valve, Intake & Exhaust	16
8	QRE31617	Cap, Valve Stem	8



For Tractors with 4 Valve Cylinders

	Part No.	Description	Qty.
1	QR502370	Valve, Exhaust	8
2	QR502369	Valve, Inlet	8

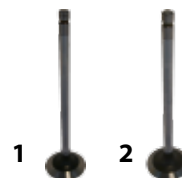

Ring Sets & Balancer Shafts

	Part No.	Description
1	QRE66271	Ring Sets
2	QRE500448	Balancer Shaft Right
3	QRE500449	Balancer Shaft Left

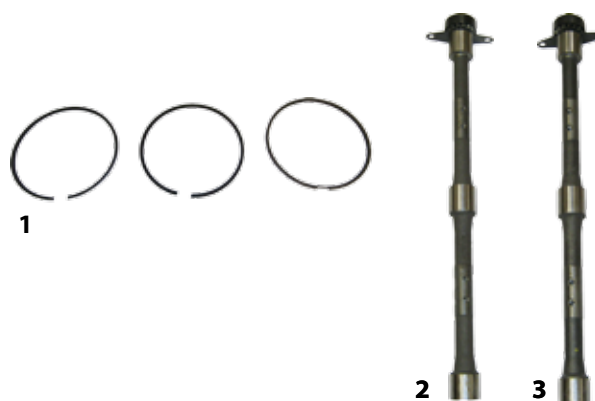

	Part No.	Description	98000 Standard Overhaul Kit	98010 .010" Kit
1	QRE507920	Cylinder Kit* Bore 106.5	4	4
1A	QAR65507	O Ring Kit Liner Seals	1	1
2	QRE501455	Gasket Set	1	1
3	QR115299	Balance Bush	6	6
4	QR119874	Cam Bush	1	1
5	QR123960	Rod Bush	4	4
6	QRE65168	Thrust Bearing STD	1	
7	QRE65908	Rod Bearing STD	4	
8	QRE65165	Main Bearing STD	4	
9	QRE65912	Thrust Bearing 10 Thou		1
10	QRE65909	Rod Bearing 10 Thou		4
11	QRE65911	Main Bearing 10 Thou		4



*Gasket Set

Gasket Set QRE501455 Contains		
R116515-B	Gasket, Cyl Head, 4.5 PT	1
RE516340	Seal, Crankshaft, Front	1
RE44574	SEAL,CRANKSHAFT,REAR	1
R92097-B	Gasket, Turbo Mount	1
R123226-B	Seal, Water Bypass Tube	2
R90658-B	Gasket, Exhaust Manifold	4
R123570-B	Gasket, Turbo Oil Drain	1
R54638-B	Gasket, Thermostat Cover, Dual	1
R123345-B	Gasket, Tstat Housing	1
R121416-B	Gasket, Water Pump To Head	1
R81275-B	Gasket, Air Inlet	2
R123575-B	O-Ring	4
R503891-B	Gasket, Turbo Oil Drain	1
R136516-B	Gasket, Timing Cover	1
R136515-B	Gasket, Timing Cover	1
R520131-B	Gasket, Timing Cover	1

R520132-B	Gasket, Timing Cover	1
A4827R-B	Washer, Special Aluminum	1
R123501-B	Gasket, Oil Cooler Housing	1
R502864-B	Gasket, Remote OF Adapter	1
R53108-B	Gasket, Starter to Block	1
R72328-B	O-Ring, Turbo Return/Water	4
R123273-B	O-Ring, Fuel Pump	1
R89944-B	O-Ring, Injector Pump Mount	1
R61105-B	O-Ring, Tube to Timing Cover	2
T122075-B	O-Ring	2
R500374-B	Gasket, Oil Filter Header	1
R123525-B	Gasket, Oil Filter Header	1
R501428-B	Gasket, Coolant Passage	1
R123417-B	Gasket, Water Pump	1
R502902-B	Packing, Oil Fill Cap	1
R136495-B	Gasket, Oil Fill Cover	3

Rod Bolts

Part No.	Description	Qty.	Note
QR114083	Rod Bolt	8	For Con Rods Marked: R123959 (64mm Long)
QR501124	Rod Bolt Long	8	For Con Rods Marked: R500000 (61mm Long)

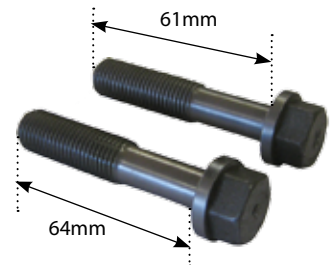

Gaskets

	Part No.	Description	Qty.
1	QRE66082	Head Set	1
2	QRP793	Sump Gasket Set	1

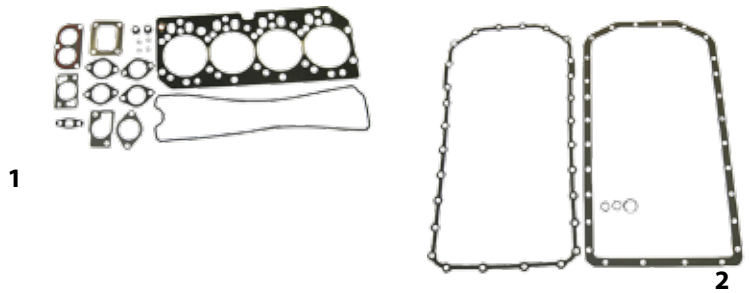

Valve Kit

Valve Kit 59235 Contains			
	Part No.	Description	Qty.
1	QR98062	Valve, Intake	4
2	QR90692	Valve, Exhaust	4
3	QR85687	Valve Seat, Exhaust	4
4	QR98063	Valve Seat, Intake	4
5	QRE60005	Rotator, Intake & Exhaust	8
6	QR26125	Spring, Valve, Intake & Exhaust	8
7	QR91889	Lock, Valve, Intake & Exhaust	16
8	QRE31617	Cap, Valve Stem	8



Ring Sets

	Part No.	Description
1	QRE507852	Ring Sets
2	QRE500448	Balancer Shaft Right
3	QRE500449	Balancer Shaft Left

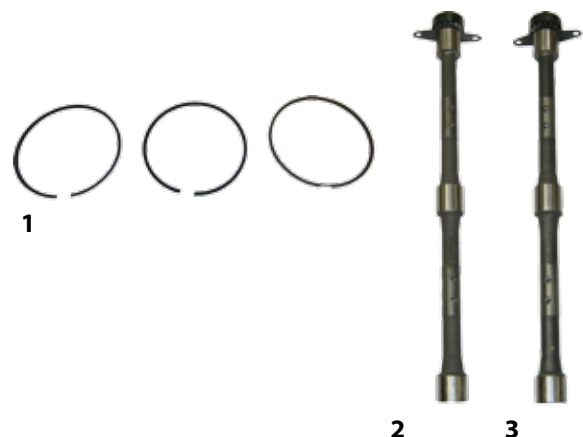

6068D 6.8D Powertech®

350 Series 6.8 Litres 6 Cylinders

	Part No.	Description	97000 Standard Overhaul Kit	97010 .010" Kit
1	QRE505110	Cylinder Kit Bore 106.5	6	6
1A	QAR65507	O Ring Kit	6	6
2	QRE501456	Gasket Set	1	1
3	QR119874	Cam Bush	1	1
4	QR123960	Rod Bush	6	6
5	QRE65168	Thrust Bearing STD	1	
6	QRE65908	Rod Bearing STD	6	
7	QRE65165	Main Bearing STD	6	
8	QRE65912	Thrust Bearing 10 Thou		1
9	QRE65909	Rod Bearing 10 Thou		6
10	QRE65911	Main Bearing 10 Thou		6

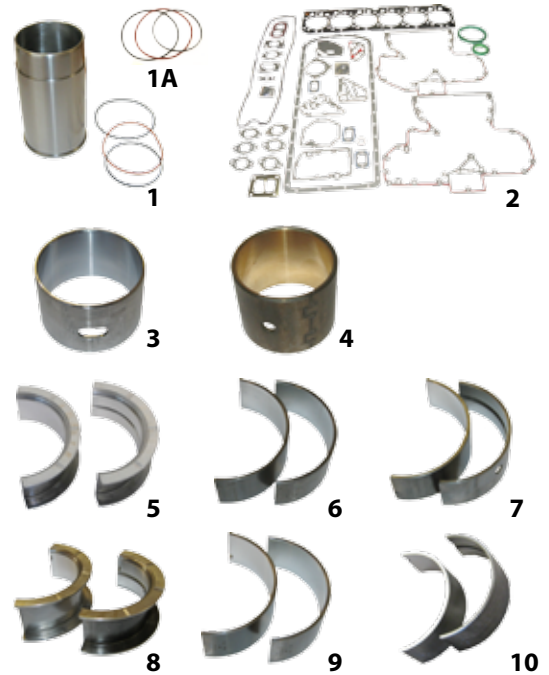

*Gasket Set

Gasket Set QRE501456 Contains			
RE516340	Seal, Crankshaft, Front	1	
RE516340-B	Seal, Crankshaft, Front	1	
RE44574	Seal, Crankshaft, Rear	1	
R116516-B	Gasket, Cyl Head, 6.8 PT	1	
R123572-B	Gasket, Turbo Mount	1	
R123226-B	Seal, Water Bypass Tube	2	
R90658-B	Gasket, Exhaust Manifold	6	
R123570-B	Gasket, Turbo Oil Drain	1	
R54638-B	Gasket, Thermostat Cover, Dual	1	
R123345-B	Gasket, Tstat Housing	1	
R121416-B	Gasket, Water Pump To Head	1	
R81275-B	Gasket, Air Inlet	2	
R123575-B	O-Ring	6	
R136516-B	Gasket, Timing Cover	1	
R136515-B	Gasket, Timing Cover	1	
R520131-B	Gasket, Timing Cover	1	

R520131-B	Gasket, Timing Cover	1	
R520132-B	Gasket, Timing Cover	1	
A4827R-B	Washer, Special Aluminum	1	
R123501-B	Gasket, Oil Cooler Housing	1	
R502864-B	Gasket, Remote OF Adapter	1	
R53108	Gasket, Starter to Block	1	
R72328-B	O-Ring, Turbo Return/Water	4	
R123273-B	O-Ring, Fuel Pump	1	
R89944	O-Ring, Injector Pump Mount	1	
R61105-B	O-Ring, Tube to Timing Cover	2	
T122075-B	O-Ring	2	
R500374-B	Gasket, Oil Filter Header	1	
R123525-B	Gasket, Oil Filter Header	1	
R501428-B	Gasket, Coolant Passage	1	
R123417-B	Gasket, Water Pump	1	
R502902-B	Packing, Oil Fill Cap	1	
R136495-B	Gasket, Oil Fill Cover	3	

Cylinder Kit Tier II

QRE516227

Cylinder Kit Tier II John Deere 6320 6420



Rod Bolts

Part No.	Description	Qty.	Note
QR114083	Rod Bolt	12	For Con Rods Marked: R123959 (64mm Long)
QR501124	Rod Bolt Long	12	For Con Rods Marked: R500000 (61mm Long)

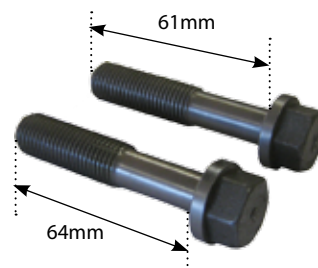

Gaskets

	Part No.	Description	Qty.
1	QRE66083	Head Set	1
2	QRP794	Sump Gasket Set	1

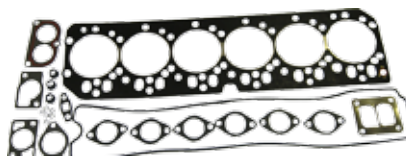

1

2

Valve Kit

Valve Kit 59235 Contains			
	Part No.	Description	Qty.
1	QR98062	Valve, Intake	6
2	QR90692	Valve, Exhaust	6
3	QR85687	Valve Seat, Exhaust	6
4	QR98063	Valve Seat, Intake	6
5	QRE60005	Rotator, Intake & Exhaust	12
6	QR26125	Spring, Valve, Intake & Exhaust	12
7	QR91889	Lock, Valve, Intake & Exhaust	24
8	QRE31617	Cap, Valve Stem	12



For Tractors with 4 Valve Cylinders

	Part No.	Description	Qty.
1	QR502370	Valve, Exhaust	12
2	QR502369	Valve, Inlet	12

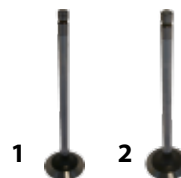

Ring Sets

	Part No.	Description
1	QRE66271	Ring Sets



1

6068T 6.8T Powertech®

350 Series 6.8 Litres 6 Cylinders

	Part No.	Description	99000 Standard Overhaul Kit	99010 .010" Kit
1	QRE507920		6	6
1A	QAR65507	O Ring Kit	6	6
2	QRE501456	Gasket Set*	1	1
3	QR119874	Cam Bush	1	1
4	QR123960	Rod Bush	6	6
5	QRE65168	Thrust Bearing STD	1	
6	QRE65908	Rod Bearing STD	6	
7	QRE65165	Main Bearing STD	6	
8	QRE65912	Thrust Bearing 10 Thou		1
9	QRE65909	Rod Bearing 10 Thou		6
10	QRE65911	Main Bearing 10 Thou		6



*Gasket Set

Gasket Set QRE501456 Contains			
RE516340	Seal, Crankshaft, Front	1	
RE516340-B	Seal, Crankshaft, Front	1	
RE44574	Seal, Crankshaft, Rear	1	
R116516-B	Gasket, Cyl Head, 6.8 PT	1	
R123572-B	Gasket, Turbo Mount	1	
R123226-B	Seal, Water Bypass Tube	2	
R90658-B	Gasket, Exhaust Manifold	6	
R123570-B	Gasket, Turbo Oil Drain	1	
R54638-B	Gasket, Thermostat Cover, Dual	1	
R123345-B	Gasket, Tstat Housing	1	
R121416-B	Gasket, Water Pump To Head	1	
R81275-B	Gasket, Air Inlet	2	
R123575-B	O-Ring	6	
R136516-B	Gasket, Timing Cover	1	
R136515-B	Gasket, Timing Cover	1	
R520131-B	Gasket, Timing Cover	1	

R520131-B	Gasket, Timing Cover	1	
R520132-B	Gasket, Timing Cover	1	
A4827R-B	Washer, Special Aluminum	1	
R123501-B	Gasket, Oil Cooler Housing	1	
R502864-B	Gasket, Remote OF Adapter	1	
R53108	Gasket, Starter to Block	1	
R72328-B	O-Ring, Turbo Return/Water	4	
R123273-B	O-Ring, Fuel Pump	1	
R89944	O-Ring, Injector Pump Mount	1	
R61105-B	O-Ring, Tube to Timing Cover	2	
T122075-B	O-Ring	2	
R500374-B	Gasket, Oil Filter Header	1	
R123525-B	Gasket, Oil Filter Header	1	
R501428-B	Gasket, Coolant Passage	1	
R123417-B	Gasket, Water Pump	1	
R502902-B	Packing, Oil Fill Cap	1	
R136495-B	Gasket, Oil Fill Cover	3	

Rod Bolts

Part No.	Description	Qty.	Note
QR114083	Rod Bolt	12	For Con Rods Marked: R123959 (64mm Long)
QR501124	Rod Bolt Long	12	For Con Rods Marked: R500000 (61mm Long)

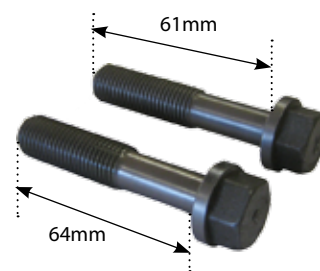

Gaskets

	Part No.	Description	Qty.
1	QRE66083	Head Set	1
2	QRP794	Sump Gasket Set	1

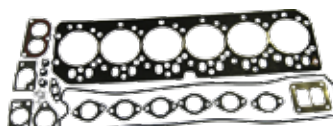

1



2

Valve Kit

Valve Kit 59235 Contains			
	Part No.	Description	Qty.
1	QR98062	Valve, Intake	6
2	QR90692	Valve, Exhaust	6
3	QR85687	Valve Seat, Exhaust	6
4	QR98063	Valve Seat, Intake	6
5	QRE60005	Rotator, Intake & Exhaust	12
6	QR26125	Spring, Valve, Intake & Exhaust	12
7	QR91889	Lock, Valve, Intake & Exhaust	24
8	QRE31617	Cap, Valve Stem	12



Ring Sets

	Part No.	Description
1	QRE507852	Ring Sets



1

4045T Turbo High Horsepower 4.5T Powertech®

350 Series 4.5 Litres 4 Cylinders

	Part No.	Description	99500 Standard Overhaul Kit	99510 .010" Kit
1	QRE507850	Cylinder Kit 106.5 Bore	4	4
1A	QAR65507	O Ring Kit	4	4
2	QRE501455	Gasket Set*	1	1
3	QR115299	Balance Bush	6	6
4	QR119874	Cam Bush	1	1
5	QR114082	Rod Bush	4	4
6	QRE65168	Thrust Bearing STD	1	
7	QRE65908	Rod Bearing STD	4	
8	QRE65165	Main Bearing STD	4	
9	QRE65912	Thrust Bearing 10 Thou		1
10	QRE65909	Rod Bearing 10 Thou		4
11	QRE65911	Main Bearing 10 Thou		4



*Gasket Set

Gasket Set QRE501455 Contains		
R116515-B	Gasket, Cyl Head, 4.5 PT	1
RE516340	Seal, Crankshaft, Front	1
RE44574	SEAL,CRANKSHAFT,REAR	1
R92097-B	Gasket, Turbo Mount	1
R123226-B	Seal, Water Bypass Tube	2
R90658-B	Gasket, Exhaust Manifold	4
R123570-B	Gasket, Turbo Oil Drain	1
R54638-B	Gasket, Thermostat Cover, Dual	1
R123345-B	Gasket, Tstat Housing	1
R121416-B	Gasket, Water Pump To Head	1
R81275-B	Gasket, Air Inlet	2
R123575-B	O-Ring	4
R503891-B	Gasket, Turbo Oil Drain	1
R136516-B	Gasket, Timing Cover	1
R136515-B	Gasket, Timing Cover	1
R520131-B	Gasket, Timing Cover	1

R520132-B	Gasket, Timing Cover	1
A4827R-B	Washer, Special Aluminum	1
R123501-B	Gasket, Oil Cooler Housing	1
R502864-B	Gasket, Remote OF Adapter	1
R53108-B	Gasket, Starter to Block	1
R72328-B	O-Ring, Turbo Return/Water	4
R123273-B	O-Ring, Fuel Pump	1
R89944-B	O-Ring, Injector Pump Mount	1
R61105-B	O-Ring, Tube to Timing Cover	2
T122075-B	O-Ring	2
R500374-B	Gasket, Oil Filter Header	1
R123525-B	Gasket, Oil Filter Header	1
R501428-B	Gasket, Coolant Passage	1
R123417-B	Gasket, Water Pump	1
R502902-B	Packing, Oil Fill Cap	1
R136495-B	Gasket, Oil Fill Cover	3

Cylinder Kit Tier II

QRE516227

Cylinder Kit Tier II John Deere 6320 6420



Rod Bolts

Part No.	Description	Qty.	Note
QR114083	Rod Bolt	8	For Con Rods Marked: R123959 (64mm Long)
QR501124	Rod Bolt Long	8	For Con Rods Marked: R500000 (61mm Long)

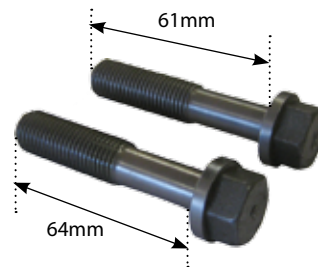

Gaskets

	Part No.	Description	Qty.
1	QRE66082	Head Set	1
2	QRP793	Sump Gasket Set	1

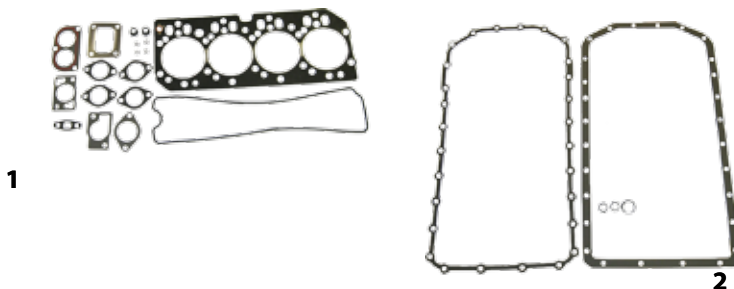

Valve Kit

Valve Kit 59240 Contains			
	Part No.	Description	Qty.
1	QR98062	Valve, Intake	4
2	QR90692	Valve, Exhaust	4
3	QR85687	Valve Seat, Exhaust	4
4	QR98063	Valve Seat, Intake	4
5	QRE60005	Rotator, Intake & Exhaust	8
6	QR26125	Spring, Valve, Intake & Exhaust	8
7	QR91889	Lock, Valve, Intake & Exhaust	16
8	QRE31617	Cap, Valve Stem	8



For Tractors with 4 Valve Cylinders

	Part No.	Description	Qty.
1	QR502370	Valve, Exhaust	8
2	QR502369	Valve, Inlet	8

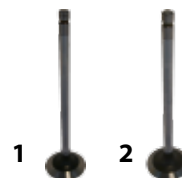

Ring Sets

	Part No.	Description
1	QRE507852	Ring Sets
2	QRE500448	Balancer Shaft Right
3	QRE500449	Balancer Shaft Left

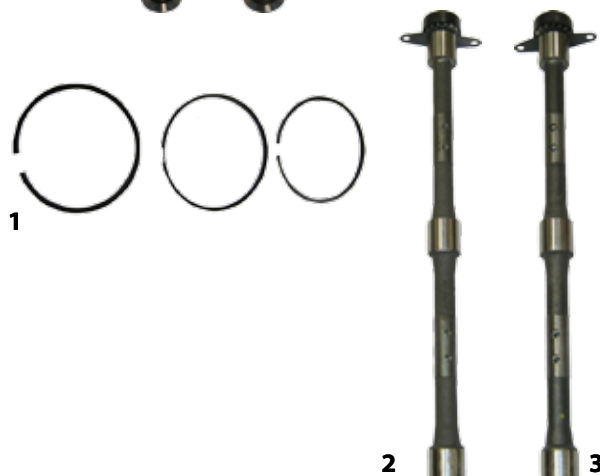

6068H Turbo High Horsepower 6.8T High Horse Powertech®

350 Series 6.8 Litres 6 Cylinders

	Part No.	Description	Standard Overhaul Kit 99600	.010" Kit 99610
1	QRE507850	Cylinder Kit Bore 106.5	6	6
1A	QAR65507	O Ring Kit	6	6
2	QRE501456	Gasket Set*	1	1
3	QR119874	Cam Bush	1	1
4	QR114082	Rod Bush	6	6
5	QRE65168	Thrust Bearing STD	1	
6	QRE65908	Rod Bearing STD	6	
7	QRE65165	Main Bearing STD	6	
8	QRE65912	Thrust Bearing 10 Thou		1
9	QRE65909	Rod Bearing 10 Thou		6
10	QRE65911	Main Bearing 10 Thou		6

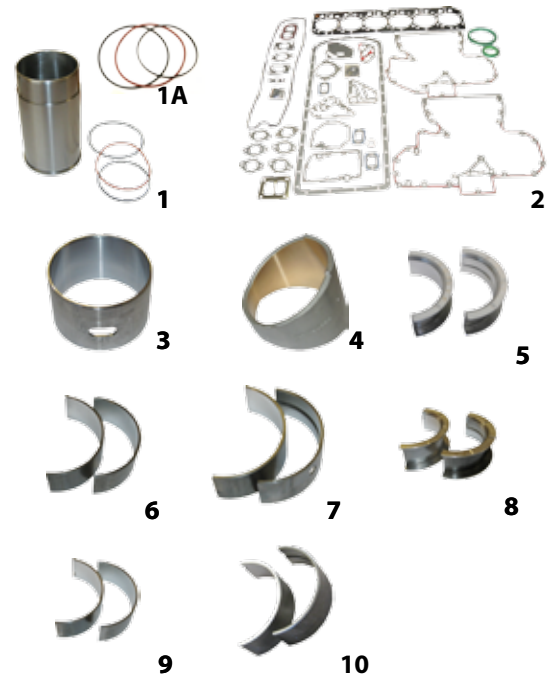

*Gasket Set

Gasket Set QRE501456 Contains			
NRE516340	Seal, Crankshaft, Front	1	
NRE516340-B	Seal, Crankshaft, Front	1	
NRE44574	Seal, Crankshaft, Rear	1	
NR116516-B	Gasket, Cyl Head, 6.8 PT	1	
NR123572-B	Gasket, Turbo Mount	1	
NR123226-B	Seal, Water Bypass Tube	2	
NR90658-B	Gasket, Exhaust Manifold	6	
NR123570-B	Gasket, Turbo Oil Drain	1	
NR54638-B	Gasket, Thermostat Cover, Dual	1	
NR123345-B	Gasket, Tstat Housing	1	
NR121416-B	Gasket, Water Pump To Head	1	
NR81275-B	Gasket, Air Inlet	2	
NR123575-B	O-Ring	6	
NR136516-B	Gasket, Timing Cover	1	
NR136515-B	Gasket, Timing Cover	1	
NR520131-B	Gasket, Timing Cover	1	

NR520132-B	Gasket, Timing Cover	1
NA4827R-B	Washer, Special Aluminum	1
NR123501-B	Gasket, Oil Cooler Housing	1
NR502864-B	Gasket, Remote OF Adapter	1
NR53108	Gasket, Starter to Block	1
NR72328-B	O-Ring, Turbo Return/Water	4
NR123273-B	O-Ring, Fuel Pump	1
NR89944	O-Ring, Injector Pump Mount	1
NR61105-B	O-Ring, Tube to Timing Cover	2
NT122075-B	O-Ring	2
NR500374-B	Gasket, Oil Filter Header	1
NR123525-B	Gasket, Oil Filter Header	1
NR501428-B	Gasket, Coolant Passage	1
NR123417-B	Gasket, Water Pump	1
NR502902-B	Packing, Oil Fill Cap	1
NR136495-B	Gasket, Oil Fill Cover	3

Tier II Cylinder Kit

QRE516227

Cylinder Kit Tier II John Deere
6320 6420 6520 6620 6820
6920



Rod Bolts

Part No.	Description	Qty.	Note
QR114083	Rod Bolt	12	For Con Rods Marked: R123959 (64mm Long)
QR501124	Rod Bolt Long	12	For Con Rods Marked: R500000 (61mm Long)

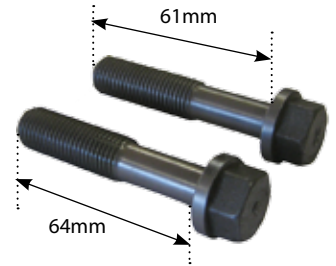

Gaskets

	Part No.	Description	Qty.
1	QRE66083	Head Set	1
2	QRP794	Sump Gasket Set	1

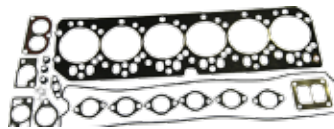

1



2

Valve Kit

Valve Kit 59235 Contains			
	Part No.	Description	Qty.
1	QR98062	Valve, Intake	6
2	QR90692	Valve, Exhaust	6
3	QR85687	Valve Seat, Exhaust	6
4	QR98063	Valve Seat, Intake	6
5	QRE60005	Rotator, Intake & Exhaust	12
6	QR26125	Spring, Valve, Intake & Exhaust	12
7	QR91889	Lock, Valve, Intake & Exhaust	24
8	QRE31617	Cap, Valve Stem	12



For Tractors with 4 Valve Cylinders

	Part No.	Description	Qty.
1	QR502370	Valve, Exhaust	12
2	QR502369	Valve, Inlet	12

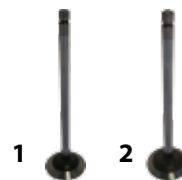

Ring Sets

Part No.	Description
QRE507852	Ring Sets

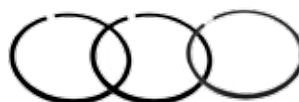

6466T Engine Type

400 Series 466 inches 6 Cylinders



RELIANCE

	Part No.	Description	Bore
1	QRE60288	Cylinder Kit	116
1A	QAR98850	O Ring Kit	
2	QR98845	Gasket Set	
3	QAR77748	Thrust Bearing STD	
4	QAR77747	Thrust Washer Set	
5	QRE22764	Seal Rear Crank	
6	QR26115	Cup Plug, Camshaft	
7	QAR73277	Rod Bearing STD	
8	QR46903	Cam Bushing	
9	QR60724	Gudgeon Bushing	
10	QAR74814	Main Bearing STD	



5



6



7



8



9



10

6076T, A, H Engine Type



RELIANCE



QRE60297
Cylinder Kit Low Ring Engine 6076
Models 4955 4960 8560 8570



QRE60294
Cylinder Kit High Ring Engine 6076
Models 455 4755 7600 7700 7800
8100 8200 8300 8400

4045H 6068HL Engine Type

QRE536083
Cylinder Kit John Deere 4045H
6068HL Bore 106.5 [OE Ref:](#)
[RE536083](#)[RE536083](#)



6081A High Compression Engines

450 Series 8.1 Litres 6 Cylinders

	Part No.	Description	99700 Standard Overhaul Kit	99710 .010" Kit	Bore
1	QRE64509	Cylinder Kit	6	6	116
1A	QAR98850	O Ring Kit			
2	QRE57187	Gasket Set*	1	1	
3	QAR49025	Seal Front	1	1	
4	QRE61253	Thrust Washer for Flange-less Bearing	1	1	
5	QR87561	Cam Bush	1	1	
6	QR74008	Rod Bush	6	6	
7	QRE520036	Seal Rear	1	1	
8	QR82007	Cup Plug, Camshaft	1	1	
9	QRE504198	Thrust Bearing Pair	1	0	
10	QR525767	Rod Bearing STD	6	0	
11	QRE529319	Main Bearing STD	6	0	
12	QRE504199	Thrust Bearing 10 Thou		1	
13	QRE534185	Rod Bearing 10 Thou		6	
14	QRE534181	Main Bearing 10 Thou		6	



*Gasket Set

Gasket Set QRE57187 Contains		
R83020-B	Gasket, Exhaust Manifold,	2
R83021-B	Gasket, Exhaust Manifold,	2
R88397-B	Gasket, Water Manifold Mount	2
R64840-B	Washer, Inj to Cyl Head	6
R77551-B	O-Ring, Fuel Injector Fitting	6
R51603-B	O-Ring, Fuel Injector	6
R124607-B	Gasket, Thermostat Cover, Dual	1
R102838-B	Gasket, Intake Manifold	3
R86743-B	O-Ring, Aftercooler	1
R50405-B	O-Ring, Intake Coupling	1
R50406-B	O-Ring, Intake Coupling	1
R89879-B	Gasket, Turbo Mount	1
R105346-B	Gasket, Turbo Oil Outlet	1
R86062-B	Gasket, T-Stat Housing to Head	1
R120646-B	Gasket, Intake Manifold	3
R119383-B	Gasket, Water Pump Cover	1
R502011-B	Gasket, Inj Pump Cover	1
R53108-B	Gasket, Starter to Block	1
R119847-B	Gasket, Oil Press Regulator	1
R26058-B	Gasket, C/S Seal Housing	1
R100569-B	Gasket, Oil Pump Intake	1
R132396-B	Gasket, Oil Cooler Cover	1
R50424-B	Gasket, Oil Cooler Adapter	1

R124030-B	Gasket, Oil Cooler Adapter	1
NR100911-B	Seal, Intercooler End	1
NT20328-B	Gasket, Oil Filler Cap	1
NR47153-B	O-Ring, Oil Cooler Tube	8
NU17409-B	O-Ring, Bypass Nut	3
NU13639-B	O-Ring, Coolant Heater Plug	1
51M4237	Washer, Copper	2
51M4238	Washer, Copper	2
R50417-B	Gasket, Oil Cooler to Block	1
R54856-B	O-Ring	1
R109625-B	Gasket, Oil Pump Housing	1
R49866-B	Gasket, Rocker Cover, 404, 466	1
R119384-B	Gasket, Timing Gear Cover	1
R88993-B	Gasket, Intercooler	2
R521228-B	Gasket, Oil Pan	1
RE47336-B	Gasket, Cyl Head, Premium	1

Rod Bolts

Part No.	Description	Qty.
QR501035	Rod Bolt (24mm Long)	12



Gaskets

Gaskets			
	Part No.	Description	Qty.
1	QRE57186	Head Set	1
2	59182	Rocker Cover Gasket	1
3	59183	Rocker Cover Gasket Upper	1

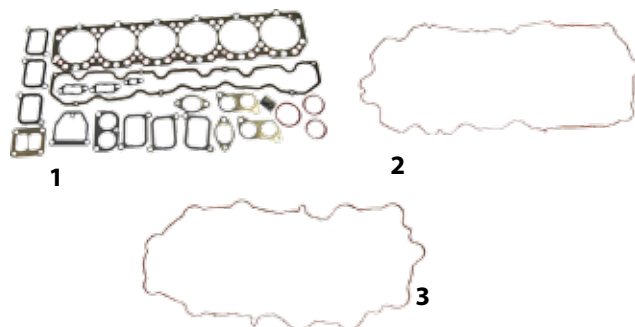

This gasket set includes a cork rocker cover gasket. After Serial No. 200,000 you need to use a 2 piece rubber rocker cover gasket 59182 59183

Valve Kit

Valve Kit 59234 Contains			
	Part No.	Description	Qty.
1	QR84618	Valve, Intake	6
2	QR84619	Valve, Exhaust	6
3	QR91822	Spring, Valve, Intake & Exhaust	12
4	QT20077	Lock, Valve, Intake & Exhaust	24
5	QT20129	Cap, Valve Stem	12

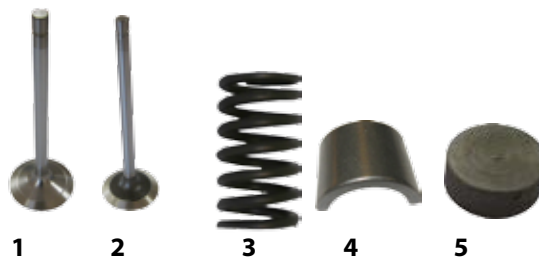

For Tractors with 4 Valve Cylinders

	Part No.	Description	Qty.
1	QR502370	Valve, Exhaust	12
2	QR502369	Valve, Inlet	12

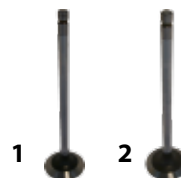

Ring Sets

Part No.	Description
QRE503528	Ring Sets



6068 24 Valve Tier 3 Engines

6530 Premium 6630 Premium 6830 Premium 6930 Premium



RELIANCE

Part No.	Description
1 QRE524450	Cylinder Kit
2 QRE530613	Piston Ring Set
3 QRE531221	Valve Inlet
4 QR502370	Valve Exhaust
5 QRE527832	Head Gasket Set
6 59568	Valve Seal
7 59569	Valve Spring
8 59567	Seat Exhaust Valve
9 59570	Seat Inlet Valve

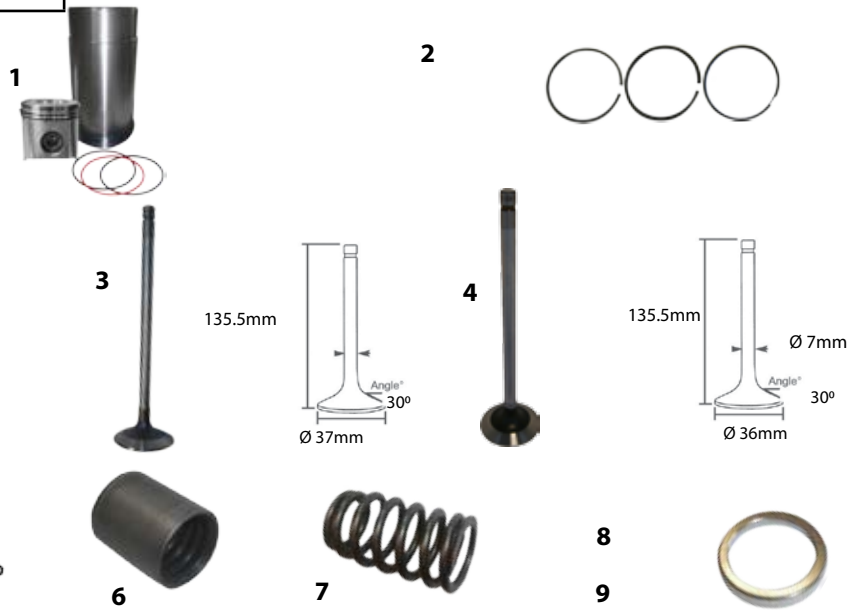

6068 24 Valve Tier 2 Engines

Part No.	Description
1 QRE516227	Cylinder Kit
2 QRE527014	Head Gasket Set



4045 16 Valve Tier 2 & Tier 3 Engines

Part No.	Description
1 QRE524450	Cylinder Kit TIER 3
2 QRE516227	Cylinder Kit TIER 2
3 QRE532842	Head Gasket Set TIER 3
4 QRE526670	Head Gasket Set TIER 2
5 QRE531221	Valve Inlet
6 QR502370	Valve Exhaust
7 59568	Valve Seal
8 59567	Seat Exhaust Valve
9 59570	Seat Inlet Valve

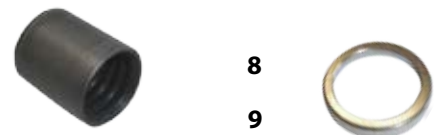
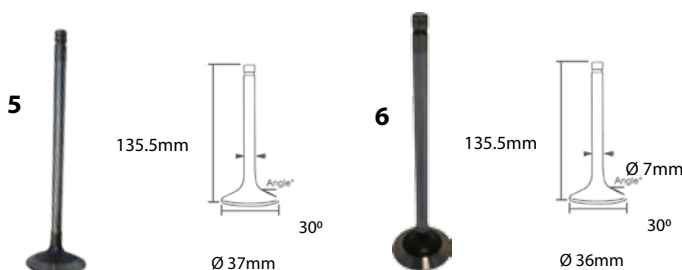
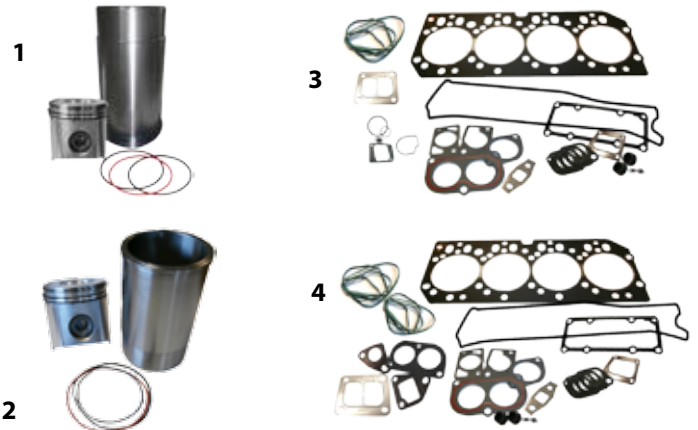

Date:.....

No. of Pages:.....

Name of the Rep.....

A/C Number:.....

From:.....

e-mail.....

Phone No.:.....

Fax No.:.....

Please quote for the following parts - Quotation Number :

I wish to confirm the following order on Quotation Number:

Please supply the following parts:

Please photocopy this page

Please do not remove this page

Qty	Part No.	Description	Unit Price
1.			
2.			
3.			
4.			
5.			
6.			
7.			
8.			
9.			
10.			
11.			
12.			
13.			
14.			
15.			
16.			
17.			
18.			
19.			
20.			
21.			
22.			
23.			
24.			

Comments:

Customer Signature:

Rep's Signature:

Tel No: + 353 44 934 1638

e-mail: info@qtponline.com, www.qtponline.com

Page of

Tier II Engine

Part No.	Description	Qty.
QRE516227	Cylinder Kit 6320 6420 6520 6620 6820 6920	6

OE Ref: RE516227



Part No.	Description	Qty.
QR502370	Valve Exhaust John Deere Powertech 6020 6320 6420 6420S 6520 6620 6820 6920 6920S 6230PR 6330PR 6430PR 6530PR 6630PR 6830PR 6930PR 7220 7320 7420 7520 7720 7820 7430PR 7530PR	12

OE Ref: R502370



Part No.	Description	Qty.
QR502369	Valve Inlet John Deere 6020 Powertech 6320 6420 6420S 6520 6620 6820 6920 6920S 7020 7220 7320 7420 7520 7720 7820	12

OE Ref: R502369



Gasket Sets

2064



Head Gasket Set
John Deere 1020
1030

2052

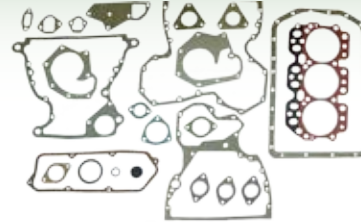

Head Gasket Set
John Deere 1020
1030 1530 163

59352

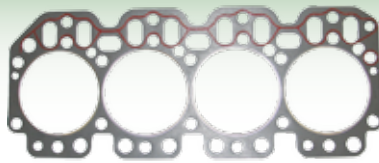

Head Gasket John
Deere 6000 6400

59791

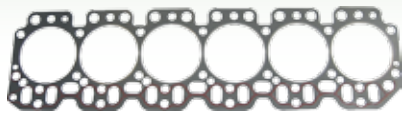

Head Gasket John Deere 3040 - 3640
3050 - 3650 6 Cylinder

59351

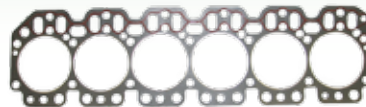

Head Gasket John Deere 6600
6900

2077

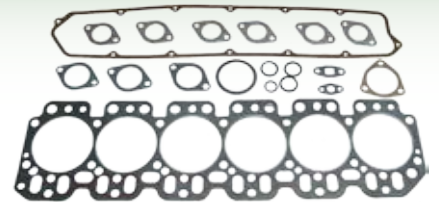

Head Gasket Set John Deere
3120 3130

59775



Head Gasket John Deere 7700
7800 8000 8100

59792



Sump Gasket John Deere 3050 - 3650 Also fits 3040
- 3640 7600 - 7800 6506 6510 6600 6800 6810 6900
6910



53086
Gasket Maker Red



52866
Gasket Maker Red
Aerosol



3171
Gasket Paper - Cork
1000 x 1000 x 3mm



3167
Gasket Paper - Plain
.8mm



3168
Gasket Paper - Plain
1 mm

Gaskets

59255

Gasket Oil Sump
John Deere 6000 -
6400 6010



59254

Head Gasket Set John
Deere 3200 3210 3300
3310 3400 3410 5500
6100 6100SE 6200
6200SE 6300 6300SE
6400 6400SE

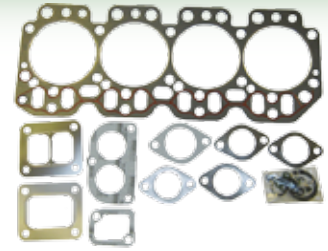

59789

Exhaust Manifold Gasket
John Deere Large Fits 7610 -
7810 6500 - 6900

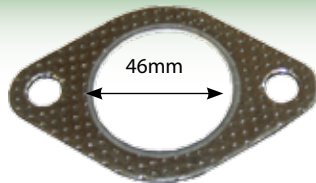

59037

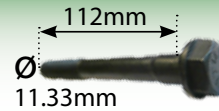

Bolt Cylinder Head John Deere
SET OF 9
Diameter 11.33mm Length 112mm
Thread 1/2 UNC

59605



Head Stud John
Deere 20s 30s 6000
7430 7530

59182

Rocker Cover Gasket John
Deere 6081A 450s Lower



59183

Rocker Cover Gasket John Deere
6081A 450s Upper



Crankshafts

59113

Crankshaft John Deere 6 Cylinder 3120
30304030 3135 2840 2940 3040 3140
3340 3640 3640S
4040 4040S 2950 3050 3150 3350 3650
4050 2955 Holes in nose



59228

Crankshaft John Deere 6 Cyl **Taper Nose**
6510 6910 6520 6920 6530 6930 7430
7530 includes Bearings and Thrust Washer
Hole in nose



59229

Crankshaft John Deere 6 Cyl **Straight Nose**
6510 6910 6520 6920 6530 6930 includes
Bearings and Thrust Washer
Holes in nose



Camshaft

58983

Camshaft Kit John Deere
6359T 6359D 6068T
OE Ref: T20073 + R82821

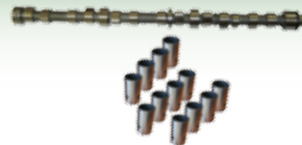

Engine Block Mounting

58852

Engine Block Mounting John Deere 6100
6200 6300 6400 6100SE 6200SE 6300SE
6400SE 6010 6110 6210 6310 6410 6020
6120 6220 6320 6420 OE Ref: AL81953



Oil Pumps

59230

Oil Pump John Deere 6010 - 6910
6020 - 6920 5620 - 5820 6030 - 6930
5080R - 5100R 5080RN - 5100RN



59165

Oil Pump John Deere 2640



QRE55343

Oil Pump John Deere 20s
30s 40s OE Ref: RE55343



59252



Oil Pump John Deere 40s
50s 6000s 4 Cyl 5000s 4 Cyl
3200 3300 Renault

Fuel Components

Fuel Injectors

51469R

Fuel Injector
John Deere
31-3350



51470R

Fuel Injector John
Deere 6100 - 6900
Also Fits John Deere
5300 - 5500



51471R

Fuel Injector
John Deere
2400 - 2850



59765R

Fuel Injector John
Deere 6010 Series
6110 - 6910 & 5620
5720 5820 7610 7710
7810 -up to Serial
Number



Cover Seals

59856

Timing Cover Seal John
Deere 10 20

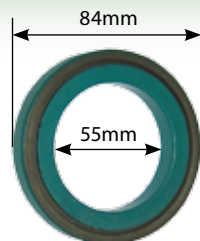

Width 12.7mm

QRE44574

Seal John Deere 40 50
Rear Crankshaft Also
6000 6010 1020 - 2120
1030 - 3130 4239T
4039T 6359T 4239D
6359D 4045T

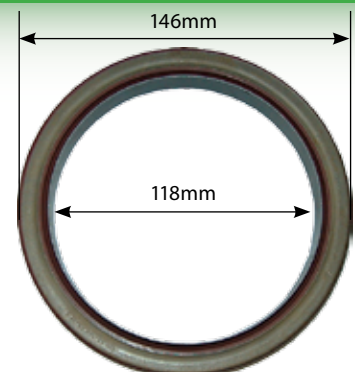

Width 14.5mm

QAR67942

Oil Seal John Deere
1020-3120 1030-4630
3100-3410 40 Series 50
Series 6000 Series 4239D
6359D 4045T 6068T 300
Series

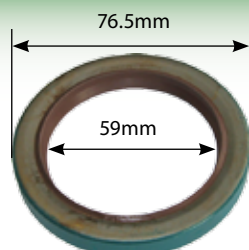

Width 10mm

59300

Seal John Deere Rear
Crankshaft Housing 10s
20s 30s 40s 50s 55s 60s

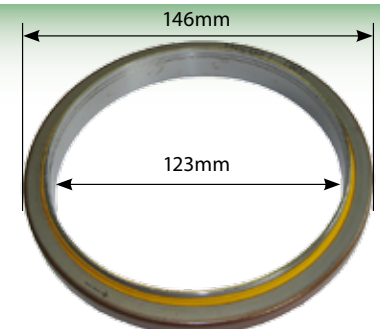

Width 20mm

SOLTRON



52814
50ml

52815
125ml

52816
500ml

52817
1 Litre

Part No.	ML	Initial Treatment 1:2,500	Refills 1:5,000
52814	50	125 Litres	250 Litres
52815	125	312.5 Litres	625 Litres
52816	500	1,250 Litres	2,500 Litres
52817	1 Ltr	2,500 Litres	5,000 Litres

Application:
For Petrol & Diesel Engines

Benefits:

- Eliminates diesel bugs
- Removes tank sludge
- Removes environmentally harmful emissions
- Reduces engine wear
- Improved fuel economy
- Saves money

Protect Your Investment

STANADYNE

Fuel Additives



53489
250ml

53404
500ml

53490
5Ltr

53810
10Ltr

53423
25Ltr

Part No.	Size	Treats
53489	250 ml	125 litres
53404	500 ml	250 litres
53490	5 litres	2500 litres
53810	10 litres	5000 litres
53423	25 litres	12,500 litres

Application

- High pressure common rail
- Unit Injectors
- Rotary Distributor Pumps
- In-line pumps

Benefits

- Upgrades and stabilizes fuel by reducing sludge and fuel tank contaminants
- Cleans and protects fuel system components
- Removes varnish and other deposits to prevent plugging
- Helps remove water from fuel
- Regular use of Stanadyne can dramatically improve power, torque and miles per gallon, while reducing smoke and other harmful emissions
- Recommended by engine and vehicle manufacturers including John Deere
- Performance formula can reduce particulate emissions by up to 49%

Date:.....

No. of Pages:.....

Name of the Rep.....

A/C Number:.....

From:.....

e-mail.....

Phone No.:.....

Fax No.:.....

Please quote for the following parts - Quotation Number :

I wish to confirm the following order on Quotation Number:

Please supply the following parts:

Please photocopy this page

Please do not remove this page

	Qty	Part No.	Description	Unit Price
1.				
2.				
3.				
4.				
5.				
6.				
7.				
8.				
9.				
10.				
11.				
12.				
13.				
14.				
15.				
16.				
17.				
18.				
19.				
20.				
21.				
22.				
23.				
24.				

Comments:

Customer Signature:

Rep's Signature:

Tel No: + 353 44 934 1638

e-mail: info@qtponline.com, www.qtponline.com

Page of

Fuel Lift Pumps



59933

Fuel Lift Pump John Deere 6000 - 6900 VDO **Fits 6110 up to 6610 & 6120 up to 6620**
For SE and Premium Tractors



59933R

Fuel Lift Pump John Deere 6000 - 6900 **Fits 6110 up to 6610 & 6120 up to 6620**



59310

Fuel Lift Pump Electric John Deere 5620 5720 5820 6020 6120 6220 6320 6420 6520 6620 6820 6920 7520 5415 6215 6415 6515 6615

59520

Fuel Lift Pump John Deere 1030- 3130 2140-4040



59457

Lift Pump John Deere 3050 4040s 3350 3650



59609

Fuel Lift Pump John Deere 7210 7410 7510 7630



59261



Fuel Lift Pump Repair Kit 6020 Series

59411

Fuel Lift Pump John Deere 6020 6030 Electric Fits Late 6020 & All 6030 - Premium & SE Also 7430 7530 Series



59816

Fuel Pump John Deere 6010 6020 Electric 6310 - 6910S & 6320 - 6920S
Also 3800 John Deere Tel-ehandler



59816R
Fuel Lift Pump John Deere Replacement type [OE Ref: RE509530](#)

STANADYNE

59333

Diaphragm Kit Delphi Injector Pump 4200 5400
John Deere ** with Metal Centre **



59036

Heater Plug John Deere 50 Series



Fuel Lines



59839

Fuel Line John Deere 10 20 - Pump to Filter



42983

Fuel Line John Deere 6200 6300 Fuel Filter 6400
6500 6600 6800 6900

Valves



59906

Check Valve Fuel Line John Deere



59906R

Valve Non Return 8mm

Common Rail Solenoids



58771

Fuel Shut Off Solenoid 6130 6230
6330 6430 6630 6830 6930 6140M
6150M 6170M [OE Ref: RE534109](#)



59561

High Pressure Pump Valve 20's
Common Rail [OE Ref: RE531864](#)



59562

Fuel Pressure Sensor 20s 30s
Common Rail [OE Ref: RE520930](#)

Fuel Senders



58854
Fuel Sender John Deere
2750 1640 1840 2040
2140 2350 2550
OE Ref: AT31619

58831
Fuel Sender John Deere
4030 4230 4430 4050
4250 4450 4350

58832
Fuel Sender John Deere
1040 1140 1640 2040 2140
OE Ref: AT31619

Fuel Tank Caps



3158
Fuel Cap John Deere 40 50

58830
Fuel Cap John Deere 1020 1120
2020 2120 3120 2440 2640 1030
1130 1630 1830 2030 2130 3030
3130 1040 1140 1640 1840 2040
2140 2240 3040 OE Ref: AT20911

59436
Fuel Tank Cap John Deere
00 10 20 **No Lock**

59840
Fuel Tank Cap John Deere 00
10 20 Lockable

Oil Caps



59391
Oil Cap John Deere 3050
3350 3640 2140 1640 2040

59390
Oil Cap John Deere 2040 - 3640 Filler
Neck Up To Serial Number 429999 1350 -
2450 2650 - 3650 All 6000 6010 6020

59401
Oil Filler Cap Engine
John Deere

59076
Oil Filler Cap John Deere 6800 6900
6810 - 6910 6820 6920 5620 5720 5820
5080R 5080RN 5090R 5090RN 5100R
5100RN 5070M 5080M 5090M

Rear Straps



59496	Tank Strap John Deere 6000 10 20 Diesel Rear - 54.6 GL Tank - Length 805mm
59497	Tank Strap John Deere 6000 10 20 Diesel Tank - 42.2 GL Tank - Length 620mm
59498	Tank Strap John Deere 6000 10 20 Diesel Front - 48.9 GL Tank - Length 715mm
59499	Tank Strap John Deere 6000 10 20 Diesel Rear - 48.9 GL Tank - Length 665mm

61-6400 (Corner Post System) Late Type 2 Piece

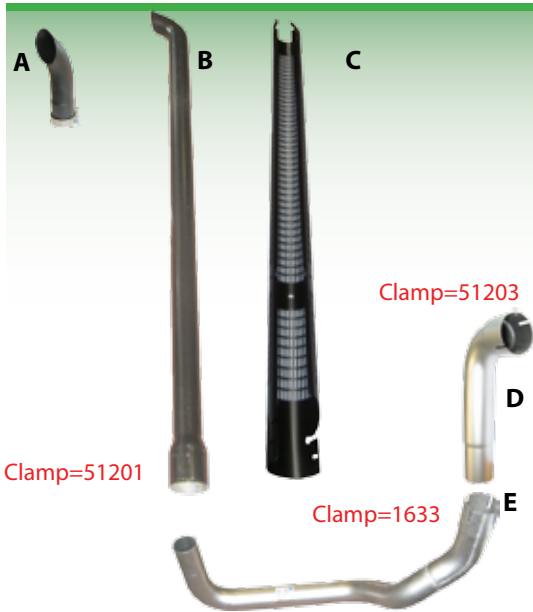

	Part Number	Description	OE Ref:
A	59309	Exhaust Tip John Deere 6000 Series c/o Clamp 65mm	
B	59489	Exhaust John Deere 6100 - 6400 Vertical Pipe Also 6110 - 6410	AL115443
C	59167	Heat Shield John Deere 6010 - 6410 6020 - 6420 5620 - 5720 - 5820 5100M 5080R - 5090R 5080RN - 5090RN 5070M - 5080M - 5090M	
D	59487	Exhaust John Deere 6100 - 6400 To Lower Pipe Also fits John Deere 6110 - 6410 Corner Post Only	L102641
E	59488	Exhaust John Deere 6100 - 6400 Pipe Lower 6110 - 6410 This Suits Only For Corner Post	L102641

6110-6410 (Corner Post System) Late Type 2 Piece

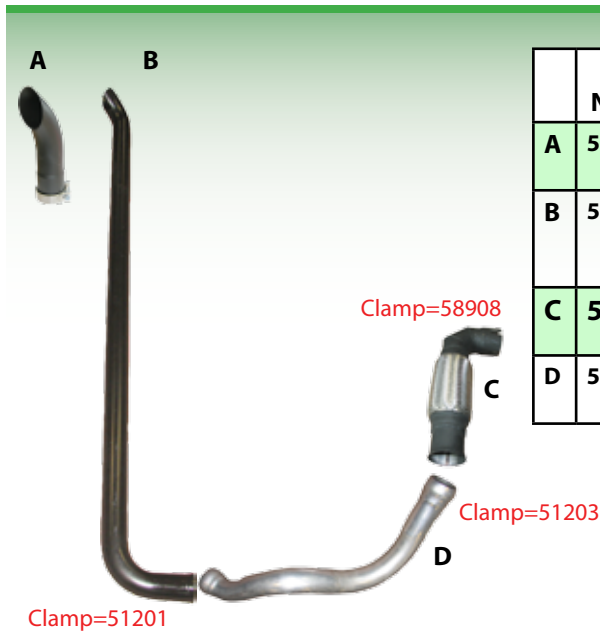

	Part Number	Description	OE Ref:
A	59309	Exhaust Tip John Deere 6000 Series c/o Clamp 65mm	
B	59365	Exhaust John Deere 6010 - 6410 Vertical Pipe From Serial Number 244529 ID 60mm Flange 74mm	AL116902
C	59367	Exhaust John Deere 6100 - 6400 To Lower Pipe 6010 - 6410 From Serial Number 244529	AL155610
D	59366	Exhaust John Deere 6100 - 6400 Lower Pipe 6010 - 6410 From Serial Number 244529	L114990

<p>59934</p>  <p>Exhaust John Deere 6000 6010 4 Cylinder **SE only - Not For Corner Post** 65 mm</p> <p>Clamp=51203</p>	<p>59635</p>  <p>Exhaust Pipe John Deere 6100 - 6400 Lower From S No.143102 for 6000 6110 - 6410 & SE **Middle of Bonnet With Turbo**</p>	<p>59376</p>  <p>Clamp=1637</p> <p>Exhaust Pipe John Deere 6100 - 6400 Under Bonnet 6110 - 6410 SE Models For Silencer Box to Exhaust Pipe - Non Turbo</p>	<p>59244</p>  <p>Exhaust Flexi Pipe John Deere 6030 - 6430 4 Cylinder Only</p> <p>59244 - Clamp</p>
<p>59061</p>  <p>Exhaust Pipe Between Flexi & Stack John Deere 6530 - 7530 Deluxe Exhaust System</p> <p>Clamp=51201</p>			

6320-6420 (Corner Post System)

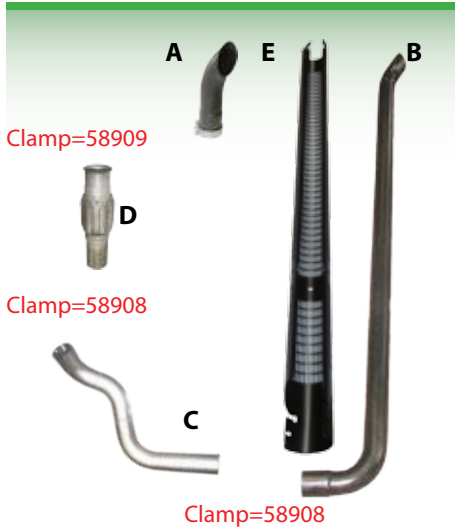

Clamp=58909

Clamp=58908

Clamp=58908

	Part Number	Description	OE ref:
A	59309	Exhaust Tip John Deere 6000 Series c/o Clamp 65mm	
B	59483	Exhaust John Deere 6320 6420 Vertical Pipe CLAMP IS 58908	AL164071
C	59482	Exhaust John Deere 6320 6420 Lower Pipe Also fits John Deere 6330	L158904
D	59481	Exhaust John Deere 6120 - 6420 Flexi Pipe 61.3mm ID for Outlet Pipe Length 230mm 61.3mm ID for Outlet Pipe Length 230mm	AL155630
E	59167	Heat Shield John Deere 6010 - 6410 6020 -6420 5620 - 5720 - 5820 5100M 5080R - 5090R5080RN - 5090RN 5070M - 5080M - 5090M	L158903

6600-6900 (Corner Post System)

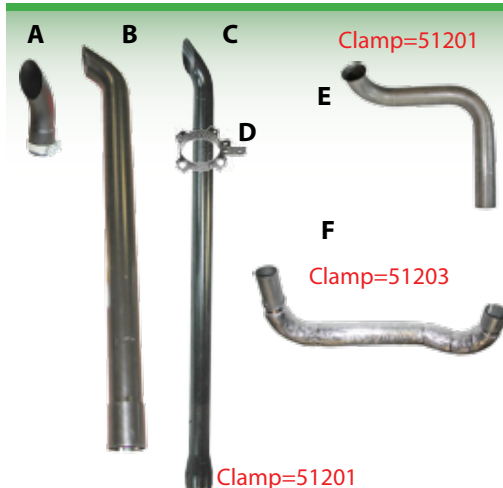

Clamp=51201

Clamp=51203

Clamp=51201

	Part Number	Description	OE ref:
A	59308	Exhaust Tip John Deere 6000 Series c/o Clamp 76mm	
B	59479	Exhaust John Deere 6506 - 6910 SE Vertical Middle of the bonnet	L112233
C	59758	Exhaust John Deere 6600 - 6900 Upper Pipe Also fits John Deere 6506	AL80953
D	59760	Exhaust Clamp John Deere 6506 - 6900	AL80508
E	59725	Exhaust John Deere 6800 6900 From Exhaust Box Curved from Exhaust Box	L102686
F	59757	Exhaust John Deere 6600 - 6900 Lower **Also fits 6506**	AL80501

6510-6910 (Corner Post System)

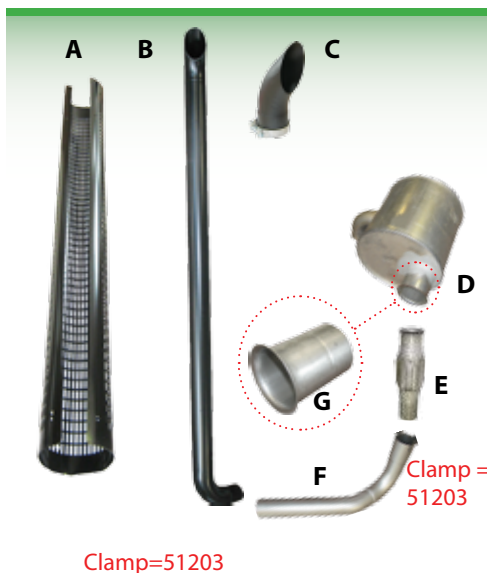

Clamp=51203

	Part Number	Description	OE ref:
A	59311	Heat Shield John Deere 6510 6610 6510 6610SE 6810 6910 6910S	L113658
B	59508	Exhaust John Deere 6510 - 6910 Corner Post	AL116287
C	59307	Exhaust Tip John Deere 7000 Series c/o Clamp 90mm	
D	59493	Exhaust Box John Deere 6810 6910	AL113911
E	59490	Exhaust Pipe John Deere 6810 - 6910 Flexi 61.0mm ID	AL114384
F	59491	Exhaust John Deere 6810 - 6910 Lower Pipe Also fits John Deere 6510 6610	L113259
G	59478	Flange Weld In John Deere Exhaust Box 6810-69	

6520-6920 (Corner Post System)

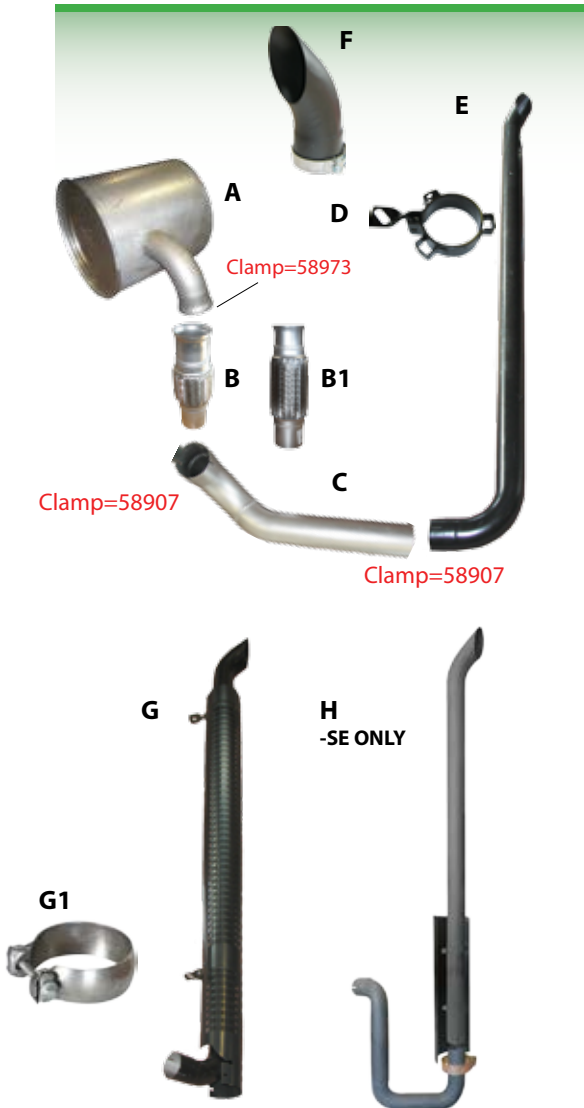

	Part Number	Description	OE ref:
A	59393	Exhaust Box John Deere 6520 6620 6820 6920	AL153972
B	59484	Exhaust John Deere 6520 - 6920 Flexi Pipe 71.6mm ID ** Clamp is 58973 AND 58907**	AL151148
B1	59060	Exhaust Pipe Flexi John Deere 6520 - 6920 6530 - 7530 Deluxe Exhaust System	AL175163
C	59485	Exhaust John Deere 6520 - 6920 Lower Pipe	L152948
D	59299	Exhaust Clamp John Deere 6520 - 6920 Also Fits 6530 - 6930 7430 7530	AL155689
E	59486	Exhaust John Deere 6520 - 6920 Vertical Pipe Also Fits 6530 - 6930 & 7430 & 7530	AL155688
F	59307	Exhaust Tip John Deere 7000 Series c/o Clamp 90mm	
G	59625	Exhaust John Deere 6820 6920 6530 6630 6830 6930 7430 7530 Corner Post Complete Includes Pipe Heat Shield &	AL164277
H	59606	Exhaust Pipe & Guard John Deere 6320SE 6420SE 6520SE 6620SE -SE ONLY	L152494 + AL170250
G1	58973	Exhaust Clamp John Deere 6520 - 6920 Exhaust Box To Flexi ** Suits 59484 & 59244 **	AL169565

7000's (Corner Post System)

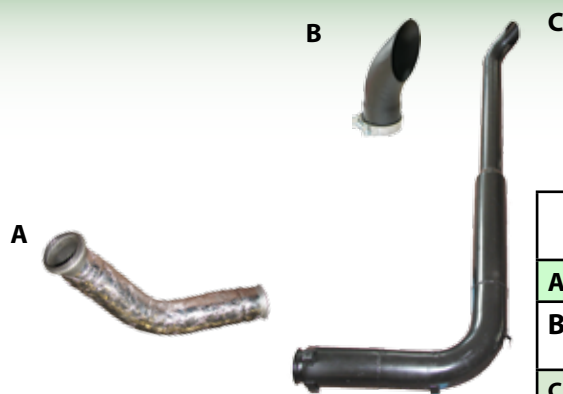

	Part Number	Description	OE ref:
A	59382	Exhaust Pipe John Deere 7710 7810 Lower	RE214148
B	59307	Exhaust Tip John Deere 7000 Series c/o Clamp 90mm	
C	59509	Exhaust John Deere 7000 7600 7700 Fits John Deere 7800 7710 7810 Lower Pipe is 59382	RE175775

Exhaust Systems

6530, 6630, 6830, 6930, 7130, 7230, 7330, 7430, 7530

Deluxe Exhaust System

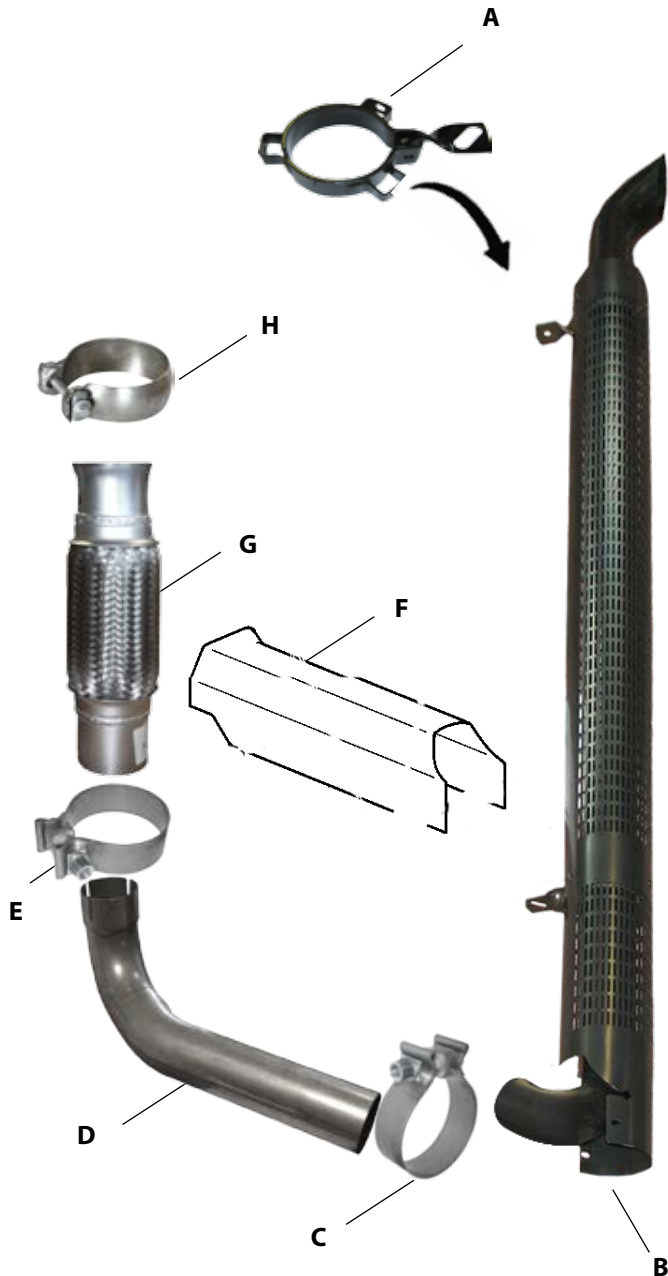

	Part	Description	OE ref:
A	59299	Exhaust Clamp - 6520 - 6920, 6530 - 6930, 7430 7530	AL155689
B	59625	Exhaust Corner Post Complete Includes Pipe Heat Shield & Bracket - 6820 6920 6530 6630 6830 6930 7430 7530	AL164277
C	58907	Exhaust Clamp 6520 6620 6820 6920 6920S 6130 6230 6330 6430 6530 6630 6830 6930 6105R 6115R 6125R 6130R 6140R 6150R 6105M	AL151150
D	59061	Exhaust Pipe Between Flexi & Stack 6530 - 7530 Deluxe Exhaust System	L168524
E	58907	Exhaust Clamp - 6520 6620 6820 6920 6920S 6130 6230 6330 6430 6530 6630 6830 6930 6105R 6115R 6125R 6130R 6140R 6150R 6105M	AL151150
F	58767	Exhaust Guard 6820 6920 6920S 6630 6830 6930 7430 7530 - New Product, Coming Soon	AL177629
G	59060	Exhaust Pipe Flexi 6520 - 6920 6530 - 7530 Deluxe Exhaust System	AL175163
H	58973	Exhaust Clamp 6520 - 6920 Exhaust Box To Flexi	AL169565

Exhaust Pipes

59895

Exhaust John Deere
830 - 1630 1040 -
2640 (Over Bonnet)
1020 1120 1350
- 1850



59896

Exhaust John Deere
1830 2030 2130
(Over Bonnet) 2020
2120



58889

Exhaust John Deere 4040 4240
4440 4640 4840 4050 4250
4450
OE Ref: RE20224



59099

Exhaust John Deere 40's/50's
Clamp=51203



59480

Exhaust John Deere 6220 - 6920
Vertical SE20 + SE 30 Series -
Middle of the Bonnet



Exhaust Pipes & Boxes

59996

Exhaust John Deere
3050 3350 3650
2650 2850 2040
2140 3040 3140
3640 **Curved End
is 58692** 1582 is
Box **

Clamp=51201

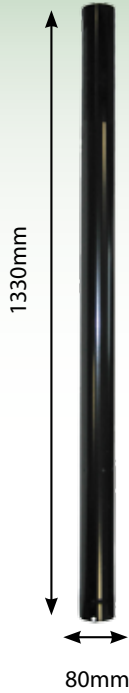

58681

Exhaust Box John Deere 1950



59999

Exhaust Box John Deere 840 940 1040
1140 1550 1750 1850 1850N 1650
Length: 22.5cm. Silencer Ø: 16



Gasket=
1752

4900

Exhaust Box John
Deere 1640 2040
1840 2140 2040S
2250 2450 2650



1582

Exhaust Box John
Deere 2140 2850
Turbo Note: This
is Not for 40 & 50
Series Non Turb



58692

Stack Pipe
3650
Curved
End

Clamp=51201



59899

Exhaust Box John Deere 3040 3140
3640 3050 3150 3350



58693

Exhaust Box John Deere 3650



59612

Exhaust Box John Deere
3040 3140 Under Bonnet



Exhaust Systems

Exhaust Boxes

59295

59114
Exhaust Outlet
Pipe John Deere
6506 6600 6800



58835 - Clamp

59478

Exhaust Box John Deere 6506 6600 6800 6900 **RH Corner Post Type**
Suits 6059T 6068T Engines

59761



59478

59477

Exhaust Box John Deere 65 - 69 65-6910 SE **SE only Not Premium** LH side of Bonnet **

58836 - Clamp



59611

Exhaust Box John Deere 6110 6110SE
6200 6200SE 6210 6210SE 6300
6300SE 6400 6400SE 6410 6410SE
Under Bonnet LH Stack



59610

Exhaust Box John Deere 6110 6110SE
6200 6200SE 6210 6210SE 6300
6300SE 6400 6400SE 6410 6410SE
Under Bonnet RH Stack

58836 - Clamp



58965

Exhaust Box John Deere 10s 20s

6010 Series

6110, 6110 L, 6210, 6210 L, 6310, 6310 L,
6310 S, 6410, 6410 L, 6510, 6510 L, 6510
S 6110 SE, 6210 SE, 6410 SE **6020 Series**
6020 6120 6120L 6120SE 6220 6220L
6220SE 6320 6320L 6320SE 6420 6420L
6420S 6420SE 6520L

OE Ref: AL117294

Weld In Flanges For Exhaust Boxes

59477

Small



59478

Large





59638



Flange Weld In John Deere Exhaust Box
7000

Oil Cooler Hoses & Water Hoses

Oil Cooler Hoses

Part No	Model	OE Ref	Type	Diameter (mm)	Hose clip	Photo
59469	6200-6400	R114099	Hose Oil Cooler	15		
59472	6506 6800-6900	R121566	Hose Oil Cooler	19	50997	
59473	6506 6800-6900	R121567	Hose Oil Cooler	19	50997	

Water Hoses

59464	1840-2140 1350-2850	R70737	Hose Bypass	18	50997	
59461	1020-1120 830-1630	T23534	Hose Top	36		
59462	1020-2120 830-2130 840	T22500	Hose Bottom	48	50988	
59459	1640-2140	L34898	Hose Top	37	50991	
59460	1640 -2140	L34921	Hose Bottom	45	50991	
59465	2250-2850	L56296	Hose Top	37	50991	
59468	2250-2850	L56295	Hose Bottom	48	50988	
59471	3040-4040S	L32456	Hose Top	49	50988	
59470	3040-4040S	L34922	Hose Bottom	58		
59467	6200-6900 6506	L111275	Hose Bottom	58	50987	
59466	6200-6400E	L100593	Hose Top	60	50987	
59463	3120 3030 3130	T28426	Hose Bottom	54	50987	
59458	840-1140 1350 344 384		Hose Top			

Hoses Clips

Original Type



Part No	Diameter (""")	Diameter (mm)
50999	5/16" - 15/32"	8-12
50998	3/8" - 5/8"	10-16
50997	15/32" - 3/4"	12-20
50996	5/8" - 1"	16-25
50995	23/32" - 1"	18-26mm
50992	7/8" - 1 3/16"	23-36
50991	1 27/64" - 1 39/64"	36-41mm
50990	1 21/32" - 1 27/32"	42-47mm
50989	1 49/64" - 1 31/32"	45-50mm
50988	1 5/16" - 2 3/8"	40-60mm
50986	2 3/8" - 3 3/16"	60-80
50985	2 3/4" - 3 1/2"	70-90

Standard Type



Part No	Diameter (mm)	TYPE
2340SS	9.5-12	Stainless Steel
2345SS	11-15	Stainless Steel
2346SS	12-20	Stainless Steel
2357	16-25	
2357SS	16-22	Stainless Steel
2364SS	18 - 25	Stainless Steel
2394	23-35	
2394SS	25- 35	Stainless Steel
2396	28-48	
2397SS	30 40	Stainless Steel
2413SS	35-50	Stainless Steel
2426SS	45-60	Stainless Steel
2440	50-70	
2440SS	55-70	Stainless Steel
2441SS	60-80	Stainless Steel
2443	70-90	
2443SS	70-90	Stainless Steel

Small Hose Clips

Part No	Diameter (mm)
59659	11
59660	13
59658	14
59661	17



Heavy Duty Clamp

Part No	Diameter (mm)
51934	122 - 130
51933	113 - 121



Fan Belts



Part No	Length	Air Breaks	Air Con	Models	Tension
59539	2365mm	Yes	No	6810,6910,6910S,6230,6330.	Mech
59540G	190mm	No	No	6810 6910 6910S 6230 6330	Mech
59541	2515mm	Yes	Yes	6310, 6410, 6510, 6610, 6520, 6620, 6130, 6630	Mech
59542	1915mm	No	No	6510,6610,6130,	Mech
59543	1910mm	Yes	No	6820,6920,6920S,6230,6930,	Mech
59544	2375mm	Yes	No	6820,6920,6920S,6230,6930,	Mech
59545	2505mm	Yes	Yes	6820,6920S,6930,	Mech

Fan Belts



Part No	Length	Air Breaks	Air Con	Models	Tension
59907	2190mm	No	Yes	6800 6900	Mech
59907G	2190mm	No	Yes	6800 6900 8PK2190	Mech
59947G	2205mm	No	Yes	6100 6200 8PK2205 Original 6300 6400 6600 & All SE	Mech
59948	2225m	No	Yes	6100 6200 8PK2225 Also fits 6300 6400 6600 2225mm	Hyd
59948G	2225mm	No	Yes	6100 6200 6300 6400 6600	Hyd
59949	1718mm	No	No	6100 6200 6PK1718 6300 6400 6506 6600 Premium 6100 6200 6300 6400 SE models	Mech
59949G	1718mm	No	No	6100 6200 6PK1718 6300 6400 6506 6600 Premium 6100 6200 6300 6400 SE models	Mech
59950	1700mm	No	No	6600 6800 6900 6PK1700 6506 6600 6800 6900 - W/O Air Con	Mech
59950G	1700mm	No	No	66 68 6900 6PK1700 6506 6600 6800 6900	Mech
59889G	1930mm	No	No	6010 6020 4 Cyl 8PK1930 6110 6210 6310 6410 6120 6220 6320 6420	Mech
58676	2200nn	No	No	6800 6900 8PK2200	Mech
59063	2285mm	Yes	Yes	6100 6200 6300 6400 6800 6900	Hyd
59694G	2460mm	No	Yes	6100 - 6610 M/ten 8PK2460 & A/C 6120 6130 SE and Premium Tractors	Mech
59387	2500mm	Yes	Yes	6810 6910 6910S 8PK2500 For 6810 6910 with Air Brake & Air Con 6230 6330 6430 with Air con up to Serial Numb (98-27/64")	Mech
59375	2455mm	No	Yes	6820 c/o Air Con 8PK2455 6820 - 6920S 6230 - 6930	
58675	773mm			Alternator Belt John Deere 6930 - 7530 Premiu	

Fan Belts



Part No	Length	Air Breaks	Air Con	Models	Tension
59321	1120mm	No	No	Fan Belt John Deere 2020 2120 - B44	Mech
59320	1215mm	No	No	Fan Belt John Deere 1020 1120 B59 17 x 1215 1520 2120 1030 1130 1630 2020 2120 1830 2030 X17X12151LP	Mech
59319	1328mm	No	No	3120 3130 3030 - 17 x 132 1640-2040 2040S 2140 X17X1328LP	Mech
59318	1390mm	No	No	2840 3030 3130 X17X1390LP	Mech
59325	1397mm	No	No	B53 2250 - 2850	Mech
59324	1447mm	No	No	Collar Shift 3300 B54 3410 2250 - 2650	Mech
59317	1460mm	No	No	3040 3140 X17X1460	Mech
59323	1473mm	No	No	3100-3210 2350 - 2850 B55	Mech
59322	1540mm	No	No	3050 3350 - B59	Mech

Drive Belt Overview

5020, 5M, 5R Series Tractors (5620-5820, 5070M-5100M, 5080R-5100R)

1

For Tractors **Without** Airconditioning/
Pneumatic Trailer Brake
Mechanical Tensioning

**5620-5820, 5070M,
5080M, 5080R-5100R**

Part No:	59889G
Length:	1930mm
OE Ref:	L114489

2

For Tractors **With** Pneumatic
Trailer Brake
Mechanical Tensioning

5100M

Part No:	59544
Length:	2375mm
OE Ref:	L153281

3

For Tractors **With** Air Conditioning
Mechanical Tensioning

**5620, 5720, 5070M,
5080M, 5080R, 5090R**

Part No:	58680
Length:	2475mm
OE Ref:	L111601

4

For Tractors **With** Air Conditioning And
Pneumatic Trailer Brake
Mechanical Tensioning

5820, 5090M, 5100R

Part No:	59541
Length:	2515mm
OE Ref:	L114468

5090M

Part No:	59542
Length:	1915mm
OE Ref:	L114488

5820, 5090M, 5100R

Part No:	59694G
Length:	2460mm
OE Ref:	L111600

5100M

Part No:	59545
Length:	2505mm
OE Ref:	L153282

5100M

Part No:	59543
Length:	1910mm
OE Ref:	L153280

5100M

Part No:	59375
Length:	2455mm
OE Ref:	L155538

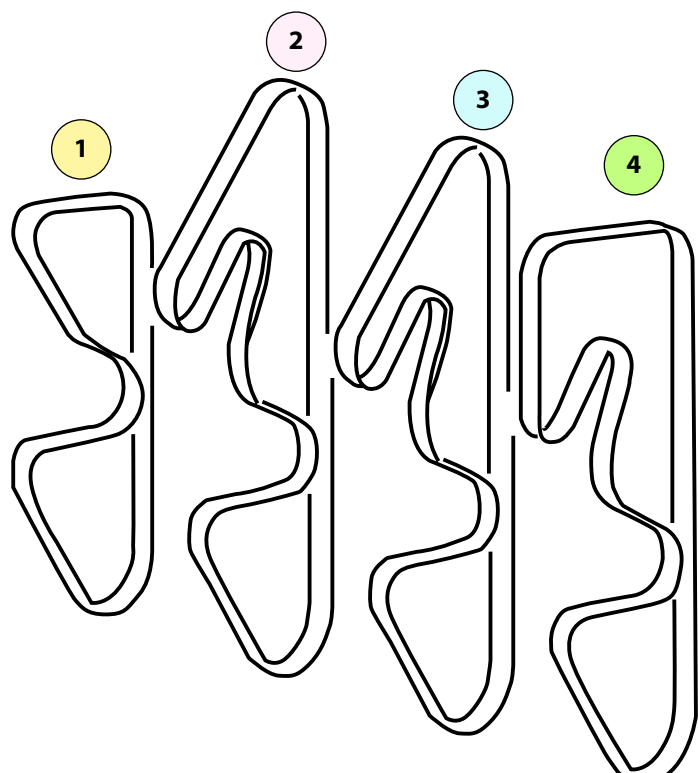

6000 Series (6100-6900, 6100SE-6400SE)

1 Tractors **Without** A/C Pneumatic Trailer Brake

6100, 6300 Up to Serial No. 125189		6200, 6400 Up to Serial No. 125189		6506, 6600 Up to Serial No. 159348		6800, 6900 Up to Serial No. 159348	
Part No:	59949G / 59949	Part No:	59949G / 59949	Part No:	59949G / 59949	Part No:	59950G / 59950
Length:	1718mm	Length:	1718mm	Length:	1718mm	Length:	1700mm
OE Ref:	L111169	OE Ref:	L111169	OE Ref:	L111169	OE Ref:	L110600
Tension:	Hydraulic	Tension:	Hydraulic	Tension:	Hydraulic	Tension:	Mechanical
From Serial No. 125190 Up to 148908		From Serial No. 125190 Up to 148908		From Serial No. 159439		6100SE, 6400SE	
Part No:	58677	Part No:	58677	Part No:	59950G / 59950	Part No:	59948G / 59948
Length:	1740mm	Length:	1740mm	Length:	1700mm	Length:	1718mm
OE Ref:	L111148	OE Ref:	L111148	OE Ref:	L110600	OE Ref:	L111169
Tension:	Hydraulic	Tension:	Hydraulic	Tension:	Mechanical	Tension:	Mechanical
From Serial No. 159439		From Serial No. 159439					
Part No:	59948G / 59948	Part No:	59948G / 59948				
Length:	1718mm	Length:	1718mm				
OE Ref:	L111169	OE Ref:	L111169				
Tension:	Mechanical	Tension:	Mechanical				

2 Tractors **With** Pneumatic Trailer Brake

6100, 6300 Up to Serial No. 159438		Part No:	58676	OE Ref:	L101411	Without Viscous Fan Only
		Length:	2200mm	Tension:	Hydraulic	

3 Tractors **With** A/C

6100, 6300 Up to Serial No. 106163		6800, 6900 Up to Serial No. 159438	
Part No:	59907G/59907	Part No:	58676
Length:	2225mm	Length:	2200mm
OE Ref:	L111170	OE Ref:	L101411
Tension:	Mechanical	Tension:	Hydraulic
From Serial No. 159439		From Serial No. 159439	
Part No:	58678	Part No:	59948G / 59948
Length:	2215mm	Length:	2190mm
OE Ref:	L110391	OE Ref:	L111804
Tension:	Mechanical	Tension:	Mechanical
6200, 6400, 6506, 6600 Up to Serial No. 159438		6100SE - 6400SE	
Part No:	59907G / 59907	Part No:	59947G
Length:	2225mm	Length:	2205mm
OE Ref:	L111170	OE Ref:	L110605
Tension:	Mechanical	Tension:	Mechanical
From Serial No. 159439			
Part No:	59947G		
Length:	2205mm		
OE Ref:	L110605		
Tension:	Mechanical		

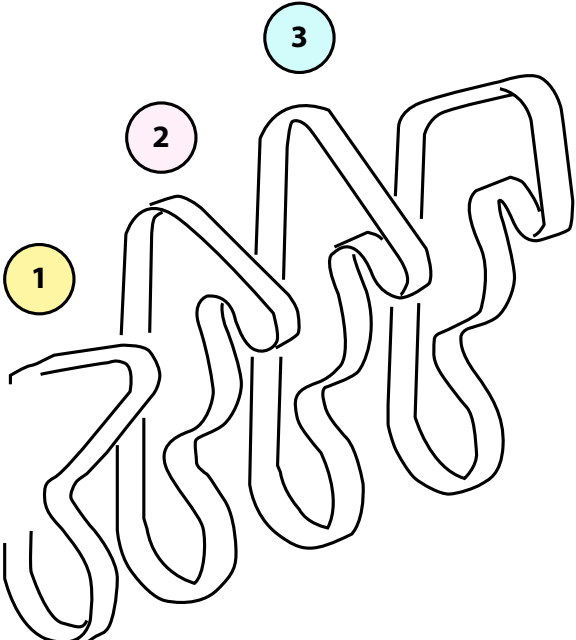

6010 Series Tractors (6010-6910S, 6010SE-6610SE, 6205, 6505)

1	2	3	4
For Tractors Without Airconditioning/ Pneumatic Trailer Brake Mechanical Tensioning	For Tractors With Pneumatic Trailer Brake Mechanical Tensioning	For Tractors With Air Conditioning Mechanical Tensioning	For Tractors With Air Conditioning And Pneumatic Trailer Brake Mechanical Tensioning
6010-6410, 6010SE-6410SE, 6205	6810-6910S	6110, 6210, 6010SE-6210SE	6310-6610, 6310SE-6610SE
Part No: 59889G	Part No: 59539	Part No: 58680	Part No: 59541
Length: 1930mm	Length: 2365mm	Length: 2475mm	Length: 2515mm
OE Ref: L114489	OE Ref: L111801	OE Ref: L111601	OE Ref: L114468

6510, 6610, 6510SE, 6610SE, 6505	
Part No: 59542	
Length: 1915mm	
OE Ref: L114488	

6310-6610, 6310SE-6610SE	
Part No: 59694G	
Length: 2460mm	
OE Ref: L111600	

6810-6910S	
Part No: 59387	
Length: 2500mm	
OE Ref: L114292	

6810-6910S	
Part No: 59540G	
Length: 1900mm	
OE Ref: L114286	

6810-6910S	
Part No: 59387	
Length: 2500mm	
OE Ref: L114292	

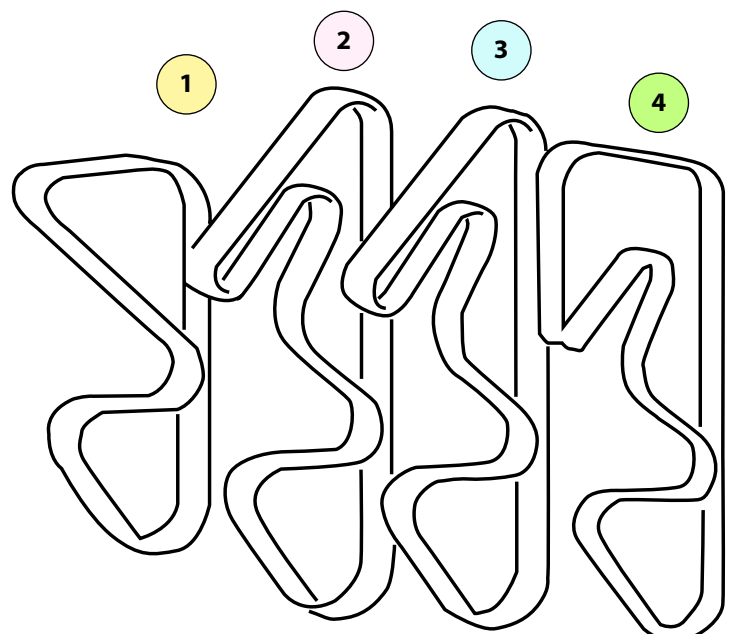

6020 Series Tractors (6020-6920S, 6020SE-6620SE, 6215, 6515)

1	2	3	4
For Tractors Without Airconditioning/ Pneumatic Trailer Brake Mechanical Tensioning	For Tractors With Pneumatic Trailer Brake Mechanical Tensioning	For Tractors With Air Conditioning Mechanical Tensioning	For Tractors With Air Conditioning And Pneumatic Trailer Brake Mechanical Tensioning
6020-6420, 6020SE-6420SE, 6215	6820-6920S	6120-6520, 6020SE-6620SE	6620
Part No: 59889G	Part No: 59544	Part No: 58680	Part No: 59541
Length: 1930mm	Length: 2375mm	Length: 2475mm	Length: 2515mm
OE Ref: L114489	OE Ref: L153281	OE Ref: L111601	OE Ref: L114468

6520, 6620, 6520SE, 6620SE, 6515	
Part No: 59542	
Length: 1915mm	
OE Ref: L114488	

6620	
Part No: 59694G	
Length: 2460mm	
OE Ref: L111600	

6820-6920S	
Part No: 59545	
Length: 2505mm	
OE Ref: L153282	

6820-6920S	
Part No: 59543	
Length: 1910mm	
OE Ref: L153280	

6820-6920S	
Part No: 59375	
Length: 2455mm	
OE Ref: L155538	

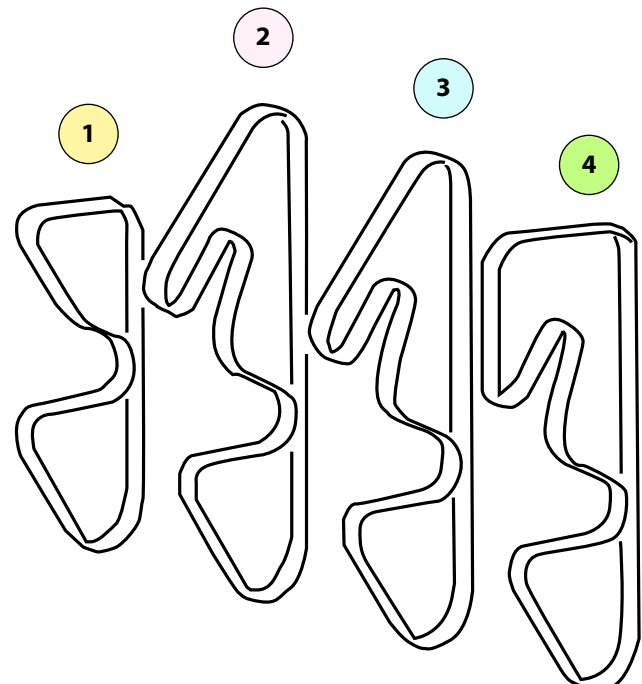

6030 Series Tractors

(6225-6525, 6130-6930, 6230-6930 Premium, 7430 & 7530 Premium)

1	2	3	4
For Tractors Without Airconditioning/ Pneumatic Trailer Brake Mechanical Tensioning	For Tractors With Pneumatic Trailer Brake Mechanical Tensioning	For Tractors With Air Conditioning Mechanical Tensioning	For Tractors With Air Conditioning And Pneumatic Trailer Brake Mechanical Tensioning
6225, 6525, 6130, 6230, 6230 Premium, 6530, 6630, 6530 Premium, 6630 Premium	6130-6430, 6230 Premium, 6330 Premium, 6930, 6830-7530 Premium	6130, 6230, 6230 Premium, 6630, 6630 Premium	6130, 6230, 6230 Premium, 6630, 6630 Premium
Part No: 59542	Part No: 59544	Part No: 59694G	Part No: 59541
Length: 1915mm	Length: 2385mm	Length: 2460mm	Length: 2515mm
OE Ref: L114488	OE Ref: L153281	OE Ref: L111600	OE Ref: L114468

6430 Premium	6430 Premium	6430 Premium	6430 Premium
Part No: 59540G	Part No: 59539	Part No: 59387	Part No: 59387
Length: 1900mm	Length: 2365mm	Length: 2500mm	Length: 2500mm
OE Ref: L114286	OE Ref: L111801	OE Ref: L114292	OE Ref: L114292

6325, 6425, 6330, 6430, 6330 Premium, 6830, 6930, 6830-7530 Premium
Part No: 59543
Length: 1910mm
OE Ref: L153280

6530, 6530 Premium
Part No: 58680
Length: 2475mm
OE Ref: L111601

6330, 6430, 6330 Premium, 6830, 6930, 6830 Premium
Part No: 59545
Length: 2505mm
OE Ref: L153282

6330, 6430, 6330 Premium, 6930, 6830 Premium
Part No: 59375
Length: 2455mm
OE Ref: L155538

6930-7530 Premium
Part No: 58679
Length: 2560mm
OE Ref: L169272

6930-7530 Premium
Part No: 58675
Length: 773mm
OE Ref: L169990

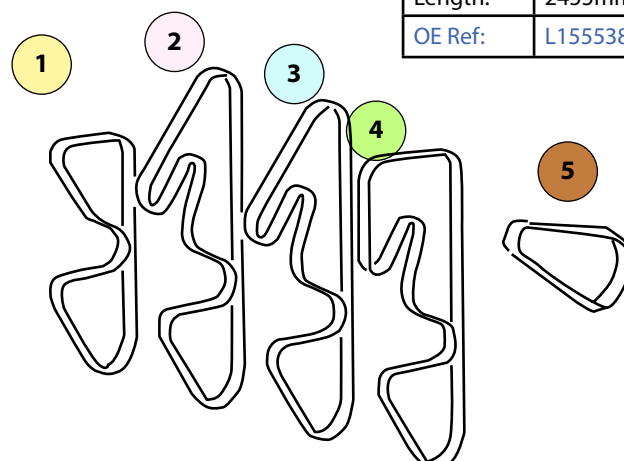

Cooling System

Water Pumps

59814



Water Pump John Deere 300
301 380 400 401 440 440A
440B 480 1020 1520 2020
300B 301A

59163



Water Pump John Deere 830
930 1020 1120 2030 2020 2120
** Repair Kit 59100 **

59100



Water Pump Repair Kit John Deere
1020 1120 2020 2120 1030 1130 1630
1830 2030 2130 3030 1350 1550 1750
1850 1950

59284



Water Pump John Deere 2020
2030 2040 2240 1020 1030 1130

59812



Water Pump John Deere 3050
3350 3650

60006



Water Pump John Deere
6100 - 6900

59979

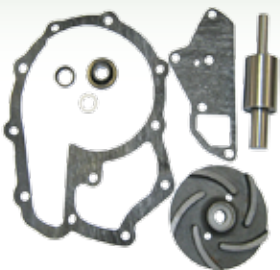

Water Pump Kit John Deere 40's 50's

59958



Water Pump Kit John Deere 40 50's
4 cyl only 4 Cyl 50's From 795107 to
829915

59095



Water Pump John Deere 2650
2650N 2850 2250
2450 1350 5300 5400 5500

58791

Gasket Water Pump 40s 50s
** Suits 59979 ** [OE Ref: R56809](#)



Cooling System

Water Pumps

59866R

Water Pump John Deere 6010 6020
6030 Standard Incl 59860 Gasket &
59853 Seal** 7610 - 7810 Also Renault
Ares 540 - 610 - 725 - 826 Claas
OE Ref: RE505980

Gasket = 59860



59859



Water Pump Repair Kit John Deere
10/20's ** Pump is 59866 **

59213

Water Pump John Deere 8.1l
Powertech 6081
7010 7020 7710 7720 7810
7820 7920 7610 7710 7810
8100 8200 8300 8400 8110
8210 8310 8120



59298

Water Pump John Deere
6230 - 7530 Premium 4045
6068 Tier3 Engines



59189



Water Pump John Deere 6076 Engine
** Repair Kit is 59188 **

59188



Water Pump Repair Kit John Deere 6076
** Water Pump is 59189 **

59253

Water Pump Gasket Outlet
Housing John Deere
6100 - 6900 5300 5400
5500



59860

Water Pump Gasket John
Deere 10 20. OE Ref:
R123417



59853

Water Pump Seal John
Deere 10 20 Series



59858

Pump Rod Seal John
Deere 6820/6920



58897

Fan Blade John Deere 3120 - 20
Series 3030 3130 1140F 1640
1640F 1840 2040 2040F 2040S
2140 OE Ref:



58896

Fan Blade John Deere 1020 1120
2020 2120 1030 1035 1130 1630
1635 1830 2030 2035 2130 2135
OE Ref: AT23180AT23180
AT26373



58896 - Water Pump to suit

Cooling System Air Conditioning



59091
Air Compressor John Deere 6000 Series 6010 Series 6020 Series
Renault Ares 540 546 550 556 566 610 616 620 626 630 636 656
696 710 [OE Ref: AL176858](#)



59550
Compressor John Deere 6000 6010 6015 6020 L Series 6030
Standard Series 7020s 7030s Renault Ares 540 546 550 556
566 [OE Ref: AL153386](#)



58790
Condensator John Deere 6020 Series 6030
Series 7030 Series [OE Ref: AL207876](#)



58789
Condensator John Deere 3050 3350 2650 2850 2450 3650
[OE Ref: AL41721](#)



59008
Receiver Dryer John Deere 40 50 6000 6010 7010 Series
[OE Ref: AL77581](#)



59552
Evaporator John Deere 2050 8030 30 40 50 55 Series
[OE Ref: AL37526](#)

Viscous Fans



59002

Viscous Fan John Deere 5080R 5090R
5100R 6225 6325 6525 6130 6230 6330
6430

OE Ref: [AL177841](#)



59001

Viscous Fan John Deere 6505 6010SE
6210SE 6310SE 6410SE 6510SE 6610SE
6010 6110 6110L 6210 6210L 6310 6310L
6310S 6410 6410L 6410S

OE Ref: [AL118091](#)



59618

Viscous Fan John Deere 6520SE
6620SE 6920SE 6520 6620 6820 6920
6920S 7220 7320 7420 7520

OE Ref: [AL155874](#)



59617

Viscous Fan John Deere 6215 6415 6120L 6220L
6320L 6420L 6520L 6020SE 6120SE 6220SE
6320SE 6420SE 6020 6220 6320 6420 6420S
6520 OE Ref: [AL155873](#)



59577

Viscous Fan John Deere 3150 3155
3255 3350 Oe Ref: [AL69178](#)



59615

Viscous Fan John Deere 3050 3350 3055
2955 OE Ref: [AL69177](#)



59000

Viscous Fan John Deere 6100SE
6200SE 6300SE 6400SE 6100
6200 6200L 6300 6300L 6400
6400L 6506 6600 6600 6800 6900
7500 6500L

OE Ref: [AL79618](#)



59619

Viscous Fan John Deere
6100SE 6200SE 6300SE
6400SE 6200 6400 6506 6600
6800 6500L

OE Ref: [AL81448](#)



59616

Viscous Fan John
Deere 6910 6910S
OE Ref: [AL111576](#)



59596

Viscous Fan John
Deere 7710 7810
RE169092

Thermostat Housing

3163

Thermostat Cap John Deere 90
Degrees 90°



59551

Thermostat Switch John Deere
5220 5320 5520 2940 30 Series
40 Series 50 Series 4560 4570
4960 5210 5310 5410 5510 5220
5320 5520 Case [OE Ref: AL59879](#)



Seals

59858

Pump Rod Seal John
Deere 6820/6920



59122

Thermostat Seal John Deere 30
Series



Thermostats

4398

Thermostat 82°

Thermostat Ford 82| c/o Pin
Case CX70 80 90 3000 Series
John Deere 40



2485666

Thermostat 82°

Thermostat 82| All
Models



59083

Thermostat John Deere
6010 6110 6210 6310
78' 6410 6505 6020
6120 6220 6320 6420
6420S 6520 6620 5620
5720 5820 6920SE 3800
3215 3220



59345

Thermostat John Deere
6820 6920 6920S



59077

Thermostat
John Deere
6020 - 6620
7220 7320



58912

Electrical Connector CAN Bus Terminator
- Electronic Control Unit John Deere 6020
6120 6220 6420 6620 6820 6920 6920S
6230 6330 6430 6530 6630 6830 6930 7430
7530 [OE Ref: RE207311](#)



58673

Sensor Coolant Temperature
John Deere SE6010 - 6410







58672

Sensor Low Water John Deere
5820 Early 6120 6220



Diesel Stop Solenoids



<p>1976</p>  <p>Solenoid 12v Diesel Stop BOSCH Type</p>	<p>2038</p>  <p>Solenoid Diesel Stop 12V CAV Type 2 Spade Connections</p>	<p>1992</p>  <p>Solenoid Diesel Stop 12V CAV Type Single Nut Connection</p>	<p>62727</p>  <p>Solenoid 12V Diesel Stop 42s 54s Plug In Type</p>
---	---	--	--

59068



Stopper Cable John Deere 20 30 401200mm

Tensioners

<p>59834</p>  <p>Pulley Tensioner John Deere Hydraulic Belt 61/62/63/64/65/66/68/6900</p>	<p>59080</p>  <p>Pulley Idler Belt John Deere 6010 - 6910 6020- 6920 5620 5720 5820 6130 - 6930 7430 7530 5080R 5080RN 5090RN 5100R 5100RN 5070M 5080M</p>
---	--



<p>59833</p>  <p>Pulley Tensioner John Deere Mechanical Belt 61/62/63/64/65/66/68/6900</p>	<p>59166</p>  <p>Fan Belt Tensioner John Deere 6100 - 6900</p>
--	--

<p>59216R</p>  <p>Fan Belt Tensioner John Deere 6010</p>	<p>59216</p>  <p>Fan Belt Tensioner John Deere 6010</p>	<p>59831</p>  <p>Pulley Tensioner Idler John Deere 6010 6020 6030 ** Tensioners are 59216 & 59215 **</p>	<p>59215</p>  <p>Fan Belt Tensioner John Deere 6020</p>	<p>59215R</p>  <p>Fan Belt Tensioner John Deere 6020</p>
--	---	--	--	--

Cooling System

Radiators

	<p>59475</p> 	<p>59448</p> 	<p>59476</p> 
<p>58895 Radiator John Deere 820 920 1020 1030 1130 1530 1630 3030 830 930 2040 2240 OE Ref: AT20849</p>	<p>Radiator John Deere 2250 - 2850 Early Type for tractors with no expansion tank</p>	<p>Radiator John Deere 3050 3350 ***Up to Serial Number 664559***</p>	<p>Radiator John Deere 3050 3350 3650 ***From Serial Number 664560***</p>

<p>59372</p> 	<p>59373</p> 	<p>59370</p> 
<p>Radiator John Deere 6506 6600 6800</p>	<p>Radiator John Deere 6110 6200 6210 6310 6410</p>	<p>Radiator John Deere 6910</p>

<p>59374</p> 	<p>59447</p> 
<p>Radiator John Deere 6200SE 6300 6400</p>	<p>Radiator John Deere 7600 7700 7800 **Also 7710 7810 up to Serial No. 089999</p>

Cooling System

Radiators

59407



Hose Kit = 59405

Radiator John Deere 6 Cylinder 20 Series
6520 6620 6820 6920 6920S SE6320
SE6420 SE6520 SE6620

59406



Hose Kit = 59405

Radiator John Deere 4 Cylinder 20 Series
Note: 59407 is for some 4 Cylinder SE models

59025



Radiator John Deere 6530 6630
6830 6930

Oil Coolers

59327

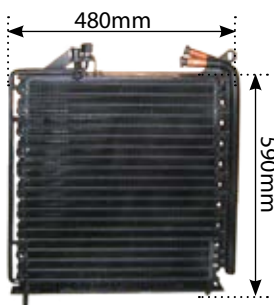

Radiator Oil Cooler John Deere 4 Cylinder For tractors with Air Conditioning 6000 6400 6010 6410

59634

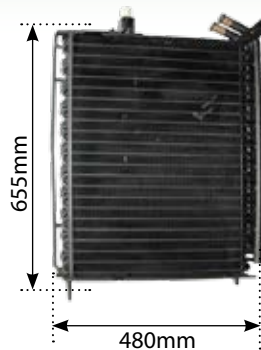

Radiator Oil Cooler John Deere 6 Cyl 6000 with A/C 6506 6600 6800 6900 & SE Model 6510 6510 6610 6810 6910 6910S (Core 23")

59085

Oil Cooler John Deere 1640 1840 2040 2140 3040 3140 3340 3640



Cooling System

Radiators Parts

63405



Drain Tap 1/4 BSP

59399



Radiator Drain Plug John Deere
6000 6010

59398



Radiator Drain Plug John Deere
6020 6030

59405

Modified Hose Kit John Deere To
Suit Oil Cool
To Suit 59407 & 59406



59586

Heater Valve John
Deere 20 Series
OE Ref: AL171742



Radiator Caps

59389

Radiator Expansion
Tank Filler Cap 1350-
2450
2650-3650



59392

Radiator Expansion Tank
Cap John Deere 6000



59397

Radiator Cap John Deere
6000 6010 6020 Filler



59395

Radiator Cap John Deere 4040
4840 4050 15lbs Up To Serial
Number



59394

Radiator Cap John Deere
940 3140 1030 1630 2020
2120 3120



59402

Radiator Cap John Deere
1640 - 3140



Individual Filters

Engine Oil Filters

1657G



Engine Oil Filter John Deere Spin on 6000 Gen **6100 - 6900** 3120 3130 2450 - 3650 Most of the 50 Series plus older models -1020

1657



Engine Oil Filter John Deere Spin on 6000 **6100 - 6900** 3120 3130 2450 - 3650 Most of the 50 Series plus older models -1020

1453G



Engine Oil Filter John Deere 6010s Genuine **Non Genuine 1453**

1453



Engine Oil Filter John Deere 6010 Series

59983



Engine Oil Filter John Deere 6020 6030 Renault Ares 836 617 656 ***Donaldson 59983R***

59983R



Engine Oil Filter John Deere 6020 6030 Renault Ares 836 617 656

5044



Engine Oil Filter John Deere 7610 7710 7810 Also 4240

58772



Engine Oil Filter 7710 7810 8120 8220 8320 8420 8520 9120 9220 9320 9420 9520 9620 7720 7820 7920 [OE Ref: RE509672](#)

Individual Filters

Fuel Filters

3527S

Fuel Filter John Deere 40 50



59668

Fuel Filter John Deere 7000 8000 9000
Also 10 20 30 US built engine 8.1L up



59640



Fuel Filter John Deere 6 cyl 6030 - Primary

59640S



Fuel Filter John Deere 6 cyl 6030's Primary

59641



Fuel Filter John Deere 6 cyl 6030's - Seconda

59641S



Fuel Filter John Deere 6 cyl 6030's Secondary

58913

Fuel Sensor John Deere 6220 6320 6420 6620 6520 6820 6920 6920S 6130 6230 6330 6430 6530 6630 6830 6930
OE Ref: RE519696



3797



Fuel Filter John Deere 6000 6010 6020 Second 109mm

3797S



Fuel Filter John Deere 6000 6010 6020 Second 109mm

59978



Water Separator Filter John Deere/ Renault

51585



Water Separator Filter Assembly Ford / John D

51586



Water Separator Filter Assy Ford/John Deere

59981

Fuel Filter John Deere 6020's Inline
Replacement is 59981R



59981R

Fuel Filter John Deere 6020's Inline
** Body 55mm - Overall Length 120mm **



41751

Fuel Filter In Line Short Gauze Type



41750

Fuel Filter Large In Line Gauze Type



Individual Filters

Fuel Filters

<p>59892</p>  <p>Fuel Filter John D 4 & 6 Cyl Premium 6020's</p>	<p>59892S</p>  <p>Fuel Filter John D 4 & 6 Cyl Premium 6020's</p>	<p>59893</p>  <p>Fuel Filter John Deere 4 Cyl Premium 6020's</p>	<p>59893S</p>  <p>Fuel Filter John Deere 4 Cyl Premium 6020's</p>
--	---	---	---

<p>59642</p>  <p>Fuel Filter John Deere 4 cyl 6030's -Secondary</p>	<p>58952</p>  <p>Fuel Filter John Deere 6105R 6115R 6125R 6130R 6105M 6115M 6125M 6130M 6140M OE Ref: RE544394RE544394</p>	<p>59120</p>  <p>Fuel Filter - Element John Deere 8130 8230 8 8530 9230</p>
<p>58913</p> <p>Fuel Sensor to suit 59642</p>		

<p>59891</p>  <p>Fuel Filter John Deere 6 Cyl Premium 6020's Primary Filter - 6620 6820 6920 6920S</p>	<p>780068</p>  <p>Fuel Filter John Deere 6 Cyl Premium 6020's Primary Filter - 6620 6820 6920 6920S</p>	<p>59890</p>  <p>Fuel Filter John Deere 6 Cyl Premium 6020's Secondary (151mm Long)</p>	<p>59890S</p>  <p>Fuel Filter John Deere 6 Cyl Premium 6020's Secondary (151mm Long)</p>
--	---	--	--

<p>409665</p>  <p>Water Separator Ford TM120-190 (30 Mic) Fuel Filter John Deere 4 cyl 6030's Secondary</p>	<p>409665L</p>  <p>Water Separator Ford TM120-190 (30 Mic) Fuel Filter John Deere 4 cyl 6030's Secondary</p>	<p>59643</p>  <p>Fuel Filter John Deere 4 Cyl 6030's - Primary</p>	<p>59643S</p>  <p>Fuel Filter John Deere 4 cyl 6030's Primary</p>
		<p>58913</p> <p>Fuel Sensor to suit 59643</p>	

Hydraulic & Transmission Filters

59763

Overall height =250mm
OD=80mm

Hydraulic Oil Filter John Deere
4 Cylinder SE



59763R

Overall height =255mm
OD=75mm

Hydraulic Oil Filter John Deere 4
Cylinder SE

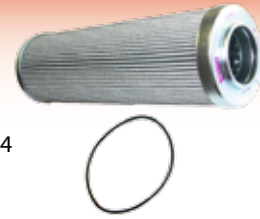

59446

Overall height =250mm
OD=105mm

Hydraulic Filter John Deere
6130 - 6930 4 & 6 Cylinders
255mm

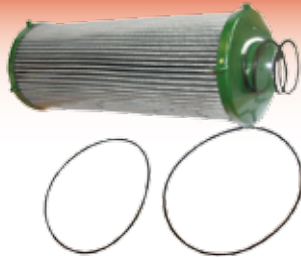

58946

Oil Filter Hydraulic and Transmission
John Deere 6510 6610 6810 6910
6910S 6320 6420 6420S 6520 6620
6820 6920 6920S 6230 6330 6430
6530 6630 6830 6930 7430
[OE Ref: AL206482](#)



59946

Overall height =205mm
OD=75mm

Hydraulic Filter John Deere 10 20 Short Also fits
Renault Ares Length 208mm



59691

Overall height =230mm
OD=75mm

Hydraulic Filter John Deere -
Autopower only



59116



Clamp John Deere Hy-
draulic Oil Filter Pipe 10
20 30 Series

6935

Overall height =208mm
OD=78mm

Hydraulic Filter John Deere 10
20 Short



58945

Hydraulic Filter John Deere 6105R 6115R 6125R
6130R 6140R 6150R 6170R 6190R 6210R 6175R
6195R 6215R [OE Ref: AL203341](#)

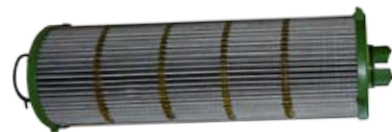

1658G

Overall height =140mm
OD=100mm

Transmission Oil Filter
John Deere 40/50 Genu-
ine 2140 - 3640 2650 2850
3050 3350 3650



1658

Overall height =140mm
OD=100mm

Transmission Oil Filter John
Deere 40 / 50 2140 - 3640 2650
2850 3050 3350 3650



3830

O Ring John Deere for
1658 Filter



AL25554

Overall height =144mm
OD=113mm

Transmission Filter John
Deere - Old Type
1020 1120 1030 1130
1630 1830 2030 2130



58948

Oil Filter John Deere
6105R 6115R 6125R
6130R 6140R 6150R
6170R 6190R 6210R
[OE Ref: DE30500](#)



Hydraulic & Transmission Filters

3800



Transmission Filter John Deere 6000 10 20 30 (Short)

3800R



Transmission Filter John Deere 6000,10,20,30 (Short)



59302
Hydraulic Filter
John Deere 4230
4040 4040S 4240
4240S 4440 4640
4840 8440 8640
4560 4760 4960
4050 4250 4350
4450 4650 4850
4055 4255
OE Ref: AR70506

58804

Transmission Filter John Deere 6100 6400 6506 6600
OE Ref: AL79010AL79010



3815



Hydraulic Filter John Deere 50 Screw On

59990



Transmission Filter John Deere 6000's (Long) 6100 - 6900 / 6110 - 6910 / 6120 - 6920

59990R



Transmission Filter John Deere 6000 - Long
6100 - 6900 6110 - 6910 6120 - 6920
Fits 50HX

59443



Hydraulic Filter John Deere 7720 7920 7730 7930 Length 195mm

2218



Hydraulic Filter

59666



Hydraulic Filter John Deere 7000 7010 7020
Also 7030 Powerquad & Autoquad Transmission
9000T Length 235mm

59667



Hydraulic Filter John Deere 7010 7020 7030
Infinite Variable Transmission Filter

P/S Filter

59314

Steering Filter John Deere 40 50 2040 - 3140 & 2250 2240 2650 3050 3350
Hydrostatic Steering Filter



Complete Filter Kits



Part No	Description
59874	Filter Kit John Deere 4 Cyl / 20's SE Range
59875	Filter Kit John Deere 6 Cyl / 20's SE Range
59876	Filter Kit John Deere 4 Cyl / 20's Premium
59877	Filter Kit John Deere 6 Cyl / 20's Premium
59878	Filter Kit John Deere 6 Cyl / 10's SE Range
59879	Filter Kit John Deere 65-69's
59880	Filter Kit John Deere 4 Cyl / 10's SE Range
59881	Filter Kit John Deere 6000-6400
59882	Filter Kit John Deere 3040/3050/3140/3150 Genuine
59883	Filter Kit John Deere 3040/3050/3140/3150
59218	Filter Kit John Deere 6520 SE 6 Cyl Front End 4 Cyl Back End

59294

Filter Screen John Deere 10 20 6810 - 6910S 6820 - 6920S



Air Filters

4631



Air Filter John Deere 2650 2850 3050 Outer ** 2355 & 2555 Up to Serial Number 634102 ** 1750 1850 2450 2755 2855N 2955 3055 3155 2250

59293-Kit

59450



Air Filter John Deere 2650 2850 3050 Inner ** 2355 & 2555 Up to Serial Number 634102** 1550 1750 1850 2250 2450 2855N 2955

1431



Air Filter John Deere 3040 3140 3150 Outer 2140DT 1640 2040 2140 2240 2750 2940 3340 3340DT 3640 ** Inner is 1433 **

59292-Kit

1433



Air Filter John Deere 2040 3040 3150 Inner 2140DT 1640 2140 2240 2750 2940 2950 3140 3340 3340DT 3640 ** Outer is 1431 **

59438

Air Filter John Deere 7700 - 7800 7710 Outer
Also fits 7810



59440

Air Filter John Deere 7700 - 7800 Inner
Also fits 7710 7810



59439

Air Filter John Deere 7600 7610 Outer



59441G

Air Filter John Deere 7600 7610 Inner



59437

Air Filter John Deere 7610 7810 7720 7930 Out



58947

Air Filter John Deere 6105R 6115R 6125R 6140R 6150R 6170R 6190R 6210R 6105M 6115M 6125M 6130M 6140M 6150M 6170M
OE Ref: RE540710



1659

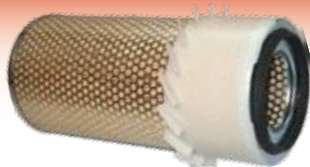

Air Filter IHC John Deere

4460

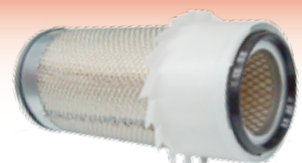

Air Filter John Deere 2040 2120 1640 Outer

Outer & Inner Air Filters

59445

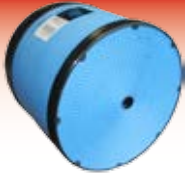

Air Filter John Deere 7720
7920 Outer
Fits 7730 7930

59444



Air Filter John Deere 7720 - 7920
Inner
Fits 7730 - 7930

59915

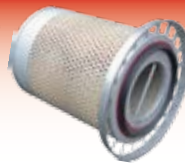

Air Filter John Deere 6500
6600 Outer
Also fits 6800 6900

59924

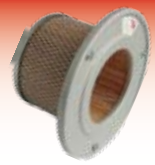

Air Filter John Deere
6500 6600 Inner
Fits 6800 6900

Kit = 59121

59925

Air Filter John Deere
6000 4 Cylinder
Outer 6100 6200
6300 6400 6110
6210 6310 6410



59884

Air Filter John Deere
6000 4 Cylinder Inner
6100 6200 6300 6400
6110 6210 6310 6410



58949

Air Filter John Deere 6105R 6115R 6125R
6110R 6120R 6130R 6105M 6110M 6120M
6130M 6115M 6125M **OE Ref: AL215055**



59810



Air Filter John Deere
20 Outer 6 Cylinder
Outer

59809



Air Filter John Deere
20 Inner 4 & 6 Cylinder
Inner

59817



Air Filter John Deere 20
Outer 4 Cylinder
Outer

58950

Air Cleaner John Deere 6110M 6120M
6130M 6135M 6145M 6155M 6175M 6195M
6105R 6115R 6125R 6140R 6130R 6150R
6170R 6190R 6210R **OE Ref: AL215054**



Cab Filters

59331



Air Filter Cab John Deere 6000 6010 6020 6030 20 & 30 Series

59279

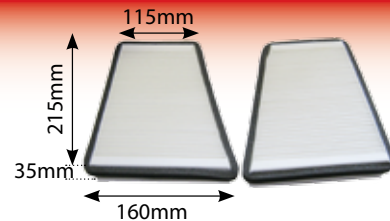

Cab Air Filter John Deere 6110 6210 6310 6410 6510 6610 6810 6910

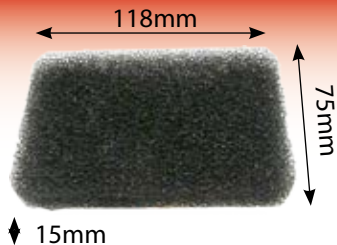

59022
Cab Air Circulation Filter John Deere 6000 -
6900 6010 - 6910 **OE Ref: L101794**

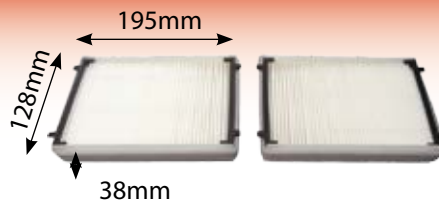

59021
Cab Air Filter John Deere 6220 - 6920 6230
- 6930 7430 7530 6105R - 6210R
OE Ref: L155288



58944
Cab Air Filter 6170R 6190R 6210R
6105R 6115R 6140R 6150R 6130R
6145R 6155R **OE Ref: L205372**

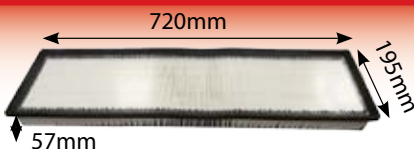

59020
Cab Filter John Deere 3040 3140 3050 3350 2650 2850 3650
OE Ref: L38598 For the SG2 without a roof hatch.

59019

Cab Filter John Deere 7700
7800 7710 7810
OE Ref: RE48882

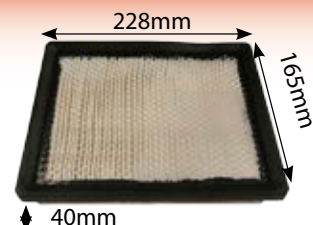

Cab Filters

58844

Cab Air Filter Dust John Deere
6610 6810 6910 6710 6650 6750
6850 6950 [OE Ref: AZ43412](#)

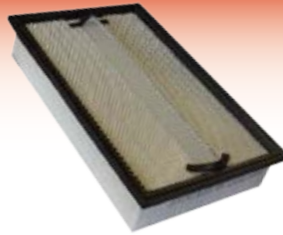

58848

Cab Air Filter Pollen John Deere 5620
5720 5820 5620 5225 5325 5425 5525
5720 5820 5070 5080M 5080R 5090M
5090R 5100M 5100R [OE Ref: RE198488](#)

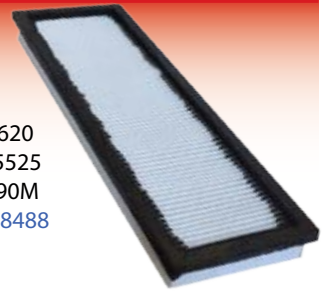

58845

Cab Air Filter Dust John Deere 5620
5720 5820 5620 5225 5325 5425 5525
5720 5820 5070 5080M 5080R 5090M
5090R 5100M 5100R [OE Ref: RE198488](#)

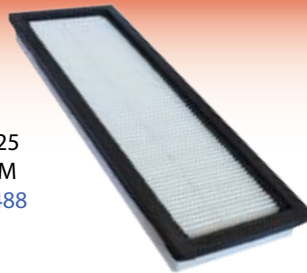

58850

Cab Air Filter Carbon Pesticide
John Deere 5320 5420 5520 5320
5420 5520 6100SE 6200SE 6400SE
6200 6300 6400 6405 6505 6506
6600
[OE Ref: AL119095CA](#)



CARBON

58847

Cab Air Filter Pollen John Deere 5620
5720 5820 5620 5225 5325 5425 5525
5720 5820 5070 5080M 5080R 5090M
5090R 5100M 5100R [OE Ref: RE151778](#)

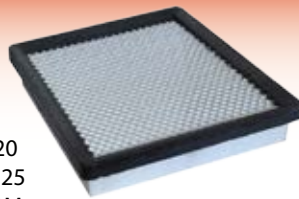

58943

Carbon Air Filter John Deere 6105R
6115R 6125R 6140R 6150R 6170R
6190R 6210R [OE Ref: AL208648](#)

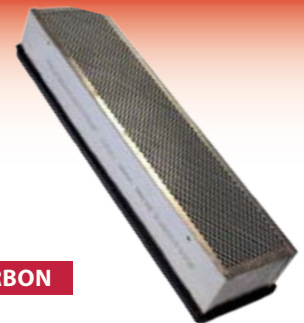

CARBON

58849

Cab Air Filter Carbon John Deere
6010SE 6110SE 6210SE 6310SE
6410SE 6510SE 6610SE 6010S
6110L 6210L 6310L 6410L 6410S
6510L [OE Ref: L156235](#)

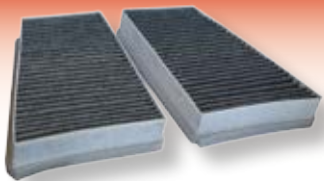

CARBON

58953

Air Filter John Deere 6105R
6115R 6125R 6130R 6140R
6150R
[OE Ref: AL212841](#)

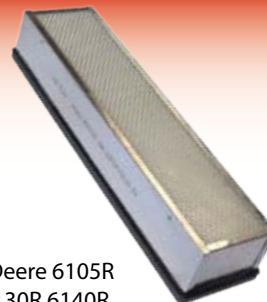

58846

Cab Air Filter Dust John
Deere 5315 5515 [OE Ref: ER200790](#)

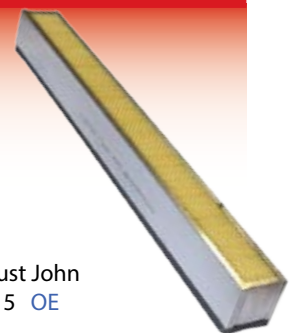

58851

Cab Air Filter Carbon John Deere
6320L 6420L 6520L 6120SE 6220SE
6320SE 6520SE 6120 6220 6420
6230 Premium 6330 Premium 6430
Premium [OE Ref: L156225](#)

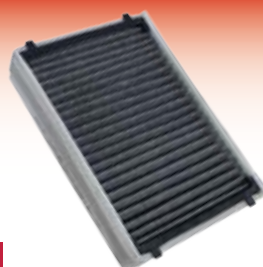

CARBON

58887

Cab Air Filter John Deere 3040 3140
3050 3350 2650 2850 3650 ** With
Roof Hatch ** 503mm x 144mm x
55mm
[OE Ref: L38596](#)

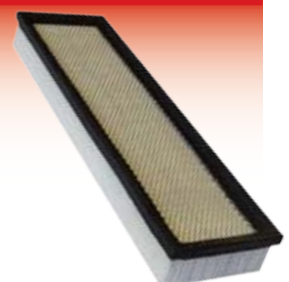

John Deere 6000 Series Filters

Genuine Oil

1657G

Engine Oil Filter John Deere Spin on 6000 Geniune



Fuel

3797

Fuel Filter John Deere 6000 6010 6020 Second



Hydraulic

3800

Filter John Deere 6000,10,20,30 (Short)



59116

Clamp Hydraulic Oil Filter Pipe John Deere 10 20 30 Series



Transmission

59946

Hydraulic Filter Short JD10/20/ Renault Ares
Oe Ref: AL203060 Premium



Replacement

1657

Engine Oil Filter John Deere Spin on 6000 Replacement



3797S

Fuel Filter John Deere 6000 6010 6020 Second
J D 7000 701 5620 5720 5820 / 3200 3400 teleh
Normal Flow 5 Micron 4.3"
Length Round End



3800R

Filter John Deere 6000,10,20,30 (Short)



6935

Hydraulic Filter 3600 6100 8100 Also fits 6200 6400 8200 Length 205mm
Hydraulic Filter John Deere 10 20 Short OE Ref: 3618662M1

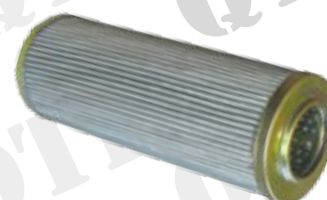

John Deere 6000 Series Filters

Cab Filter

59331

Air Filter Cab John Deere
6000 6010 6020 6030
20 & 30 Series



Air Filters

4 Cylinder Outer (6100,6200,6300,6400)



Outer 59925

Air Filter John Deere 6000
4 Cylinder Outer
6100 6200 6300 6400
6110 6210 6310 6410

4 Cylinder Inner



Inner 59884

Air Filter John Deere 6000
4 Cylinder Inner
6100 6200 6300 6400
6110 6210 6310 6410

6 Cylinder Outer (6506,6600,6800,6900)



Outer 59915

Air Filter John Deere 6500 6600
Outer
Also fits 6800 6900

6 Cylinder Inner



Inner 59924

Air Filter John Deere 6500 6600
Inner
Also fits 6800 6900

59121

Air Filter Kit
John Deere
6500 6600
6800 6900

John Deere 6010 Series Filters

Genuine ▼

Oil

1453G

Engine Oil Filter John Deere 6010s
Genuine



Replacement ▼

1453

Engine Oil Filter John Deere 6010
Series



Fuel

3797

Fuel Filter John Deere 6000 6010
6020 Second



3797S

Fuel Filter John Deere 6000 6010
6020 Second



Hydraulic

3800

Filter John Deere
6000,10,20,30
(Short)



59116

Clamp
Hydraulic Oil Filter
Pipe John Deere
10 20 30 Series

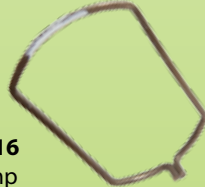

59990

Transmission Filter John Deere
6000's
(Long)



Transmission

3800

Filter John Deere
6000,10,20,30
(Short)



John Deere 6010 Series Filters

Cab Filter

59331

Air Filter Cab John Deere
6000 6010 6020 6030



Air Filters

4 Cylinder Outer (6010,6110,6210,6310,6410)



Outer 59925

Air Filter John Deere 6000
4 Cylinder Outer
6100 6200 6300 6400
6110 6210 6310 6410

4 Cylinder Inner



Inner 59884

Air Filter John Deere 6000 4 Cyl Inner
6100 6200 6300 6400 6110 6210 6310 6410

6 Cylinder Outer (6510, 6610, 6810, 6910)



Outer 59915

Air Filter Outer John Deere
65 66 68 69

6 Cylinder Inner



Inner - 59924

Air Filter Inner John Deere
5 66 68 69

John Deere 6020 Series Filters 4 Cylinder (6020, 6120, 6220, 6320, 6420)

Genuine ▼
Oil

Replacement ▼

59983

Engine Oil Filter John Deere 6020's / 6030's



Early Type With 1 Fuel Filter

3797

Fuel Filter John Deere 6000 6010 6020 Second



Late Type With 2 Fuel Filters

59981

Fuel Filter John Deere 6020's Inline



59893

Fuel Filter John Deere 4 Cyl Premium 6020's



59892

Fuel Filter John D 4 & 6 Cyl Premium 6020's



Hydraulic

59990

Transmission Filter John Deere 6000's (Long)



59983R

Engine Oil Filter John Deere 6020's / 6030's



3797S

Fuel Filter John Deere 6000 6010 6020 Second



59981R

Fuel Filter John Deere 6020's Inline



59892S

Fuel Filter John D 4 & 6 Cyl Premium 6020's



59892S

Fuel Filter John D 4 & 6 Cyl Premium 6020's



59990R

Transmission Filter John Deere 6000's (Long)



John Deere 6020 Series Filters 4 Cylinder (6020, 6120, 6220, 6320, 6420) Genuine Transmission

Replacement 

3800



Filter John Deere
6000,10,20,30
(Short)

59116



Clamp
Hydraulic Oil Filter
Pipe John Deere
10 20 30 Series

3800R

Filter John Deere 6000,10,20,30
(Short)



59946

Hydraulic Filter
JD10/20/
(Short)



Cab Filter

59331

Air Filter Cab John Deere
6000 6010 6020 6030



Air Filters

4 Cylinder Outer



Outer 59817

Air Filter Outer John Deere
20 4 Cylinder

4 Cylinder Inner



Inner 59809

Air Filter Inner John Deere 20
4/6 Cylinder

John Deere 6020 Series Filters 6 Cylinder (6520, 6620, 6820, 6920)

Genuine ▼
Oil

Replacement ▼

59983

Engine Oil Filter John Deere 6020's / 6030's



59983R

Engine Oil Filter John Deere 6020's / 6030's



Fuel

3797

Fuel Filter John Deere 6000 6010 6020 Second



3797S

Fuel Filter John Deere 6000 6010 6020 Second



59981

Fuel Filter John Deere 6020's Inline



59981R

Fuel Filter John Deere 6020's Inline



59891

Fuel Filter John Deere 6 Cyl Premium 6020's



59891S

Fuel Filter John Deere 6 Cyl Premium 6020's



59890

Fuel Filter John Deere 6 Cyl Premium 6020's



59890S

Fuel Filter John Deere 6 Cyl Premium 6020's



Hydraulic

3800

Filter John Deere 6000,10,20,30 (Short)



59116

Clamp Hydraulic Oil Filter Pipe John Deere 10 20 30 Series



59946

Hydraulic Filter Short JD10/20/Renault Ares



3800R

Filter John Deere 6000,10,20,30 (Short)



John Deere 6020 Series Filters 6 Cylinder (6520, 6620, 6820, 6920)

Genuine ▼
Transmission

Replacement ▼

59990

Hydraulic Filter Short JD10/20/
Renault Ares
(Long)



59990R

Hydraulic Filter John Deere
10/20/Ares Short
(Long)



Cab Filter

59331

Air Filter Cab John Deere
6000 6010 6020 6030



Air Filters

6 Cylinder Outer



Outer 59810
Air Filter Outer John Deere
20 6 Cylinder

6 Cylinder Inner



Inner 59809
Air Filter Inner John Deere 20
4/6 Cylinder

John Deere 6030 Series Filters 4 Cylinder 6130, 6230, 6330, 6430

Genuine ▼
Oil

Replacement ▼

59983

Engine Oil Filter John Deere 6020's / 6030's



59983R

Engine Oil Filter John Deere 6020's / 6030's



Fuel

59643

Fuel Filter John Deere 4 Cyl 6030's -
Primary



59643S

Fuel Filter John Deere 4 cyl 6030's
Primary



59642

Fuel Filter John Deere 4 cyl 6030's
-Secondary



59642S

Fuel Filter John Deere 4 cyl 6030's
Secondary



Hydraulic

59946

Hydraulic Filter Short
JD10/20/Renault Ares



6935

Hydraulic Filter 3600 6100
8100 Also fits 6200 6400
8200 Length 205mm
Hydraulic Filter John
Deere 10 20 Short **OE Ref:**
3618662M1

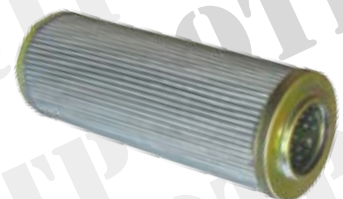

John Deere 6030 Series Filters 4 Cylinder

6130, 6230, 6330, 6430

Genuine ▼
Transmission

Replacement ▼

3800

Filter John Deere
6000,10,20,30
(Short)



59116
Clamp
Hydraulic Oil Filter
Pipe John Deere
10 20 30 Series



3800R

Filter John Deere 6000,10,20,30
(Short)



Cab Filter

59331
Air Filter Cab John Deere
6000 6010 6020 6030



Air Filters

4 Cylinder Outer



Outer 59817
Air Filter Outer John Deere
20 4 Cylinder

4 Cylinder Inner



Inner 59809
Air Filter Inner John Deere 20
4/6 Cylinder

John Deere 6030 Series Filters 6 Cylinder

6530, 6630, 6830, 6930

Genuine 
Oil

Replacement 

59983

Engine Oil Filter John Deere 6020's / 6030's



59983R

Engine Oil Filter John Deere 6020's / 6030's



Fuel

59640

Fuel Filter John Deere 6 Cyl 6030 - Primary



59640S

Fuel Filter John Deere 6 cyl 6030's Primary



59641

Fuel Filter John Deere 6 cyl 6030's - Secondary



59641S

Fuel Filter John Deere 6 cyl 6030's Secondary



Hydraulic

59446

Hydraulic Filter John Deere 6130 - 6930



6935

Hydraulic Filter 3600 6100 8100 Also fits 6200 6400 8200 Length 205mm Hydraulic Filter John Deere 10 20 Short [OE Ref: 3618662M1](#)

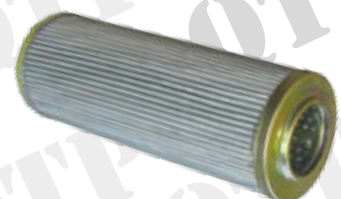

John Deere 6030 Series Filters 6 Cylinder 6530, 6630, 6830, 6930 Genuine Transmission

Replacement

3800

Filter John Deere
6000,10,20,30
(Short)



59116

Clamp
Hydraulic Oil Filter
Pipe John Deere
10 20 30 Series



59691

Hydraulic Filter
John Deere
Autopower only



3800R

Filter John Deere 6000,10,20,30
(Short)



Cab Filter

59331

Air Filter Cab John Deere
6000 6010 6020 6030



Air Filters

6 Cylinder Outer



Outer 59810

Air Filter Outer John Deere
20 6 Cylinder

6 Cylinder Inner



Inner 59809

Air Filter Inner John Deere 20
4/6 Cylinder

John Deere 5020 Series (5620 5720 5820)

Genuine ▼
Oil

Replacement ▼

59983

Engine Oil Filter John Deere 6020's / 6030's



59983R

Engine Oil Filter John Deere 6020's / 6030's



Fuel

3797

Fuel Filter John Deere 6000 6010 6020 Second



3797S

Fuel Filter John Deere 6000 6010 6020 Second



59981

Fuel Filter John Deere 6020's Inline



59981R

Fuel Filter John Deere 6020's Inline



Hydraulic

59990

Transmission Filter John Deere 6000's (Long)



59990R

Transmission Filter John Deere 6000's (Long)



Cab Filters

429959

Air Filter Kit 4200 - 373.8mm LongSuits John Deere 5620 5720 5820
3901475M1 & 3901476M

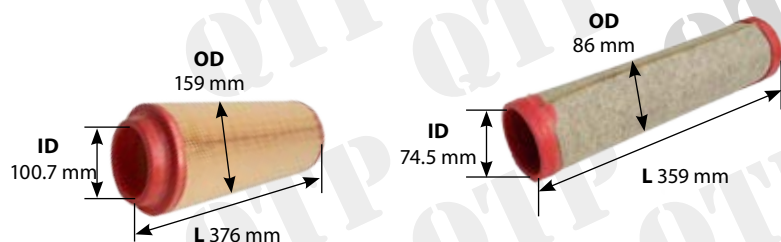

John Deere 7000 6 Cylinder 00's. 7600 Models

Genuine ▼

Replacement ▼

Air

59441G

Air Filter Inner
John Deere 7600 7610



59439G

Air Filter Outer
John Deere 7600 7610



59439

Air Filter Outer
John Deere 7600 7610



Oil

1657G

Engine Oil Filter John Deere Spin on
6000 Genuine **6100 - 6900** 3120
3130 2450 - 3650



1657

Engine Oil Filter John Deere Spin
on 6000 **6100 - 6900** 3120
3130 2450 - 3650



Fuel

3797

Fuel Filter John Deere 6000 6010
6020 Second John Deere 7000
7010 Series 5620 5720 5820 / 3200
3400 Telehandler



3797S

Fuel Filter John Deere 6000 6010 6020
Second JD 7000 701 5620 5720 5820 /
3200 3400 Telehandler
Normal Flow 5 Micron 4.3" Length
Round End



Hydraulic/ Transmission

59666

Hydraulic Filter John Deere 7000 7010
7020 Also 7030 Powerquad & Auto-
quad Transmission 9000T



59437

Air Filter Cab John Deere 7610
7810 7720 7930



Cab House



Filters

John Deere 7700/7800

Genuine ▼

Replacement ▼

Air

59440

Air Filter Inner
John Deere 77-7800 7710 7810



59438

Air Filter Outer
John Deere 77-7800 7710 7810



Oil

5044

Engine Oil Filter John Deere 7610
7710 7810



Fuel

59668

Fuel Filter John Deere 7000 8000 9000 -
Standard Also 10 20 30 US built engine
8.1L up



Hydraulic

59666

Hydraulic Filter John Deere 7000 7010
7020 Also 7030 Powerquad & Auto-
quad Transmission 9000T



John Deere 7610 - 6 Cylinder

Genuine ▼

Replacement ▼

Air

59441G

Air Filter Inner
John Deere 7600 7610



59439

Air Filter Outer
John Deere 7600 7610



Oil

1453G

Engine Oil Filter John Deere 6010s
Genuine



1453

Engine Oil Filter John Deere 6010
Series



Fuel

3797

Fuel Filter John Deere 6000 6010
6020 Second John Deere 7000
7010 Series 5620 5720 5820 / 3200
3400 Telehandler



3797S

Fuel Filter John Deere 6000 6010 6020
Second JD 7000 701 5620 5720 5820 /
3200 3400 Telehandler
Normal Flow 5 Micron 4.3" Length
Round End



Hydraulic/Transmission

59666

Hydraulic Filter John Deere 7000 7010
7020 Also 7030 Powerquad & Auto-
quad Transmission 9000T





John Deere 7710/7810

Genuine ▼

Air

Replacement ▼

Oil

Fuel

Hydraulic/Transmission

59440

Air Filter Inner
John Deere
77-7800 7710 7810



59438

Air Filter Outer
John Deere
77-7800 7710 7810

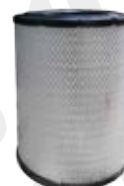

5044

Engine Oil Filter
John Deere
7610 7710 7810



59668

Fuel Filter John Deere
7000 8000 9000 - Standard Also 10 20
30 US built engine 8.1L up



59666

Hydraulic Filter John Deere 7000 7010
7020 Also 7030 Powerquad & Auto-
quad Transmission 9000T



59667

Hydraulic Filter John Deere 7010 20
30's Infitive Variable
Transmission Filter



John Deere 7720/7820/7920 6 Cylinder

Genuine ▼

Replacement ▼

Oil

59983

Engine Oil Filter
John Deere 6020's / 6030's



59983R

Engine Oil Filter
John Deere
6020's / 6030's



Fuel

59891

Fuel Filter John Deere 6 Cyl Premium
6020's Primary Filter - 6620 6820 6920
6920S
Now 30 Micron
(Was 10 Micron) 109mm



780068

Fuel Filter John Deere 6 Cyl Premium
6020's Primary Filter - 6620 6820 6920
6920S ROUND E Now 30 Micron
(Was 10 Micron) 6.0" REVERSE F



59890

Fuel Filter John Deere 6 Cyl Pre-
mium 6020's Secondary (151mm
Long)



59890S

Fuel Filter John Deere 6 Cyl
Premium 6020's Secondary (151mm Long)
NORMAL FLOW 2 MICRON 6.0" LENGTH
Round End



Hydraulic

59666

Hydraulic Filter John Deere 7000 7010
7020 Also 7030 Powerquad & Auto-
quad Transmission 9000T



59443

Hydraulic Filter
John Deere
7720 7920 7730 7930



59667

Hydraulic Filter John Deere 7010 20
30's
Infitive Variable
Transmission Filter**



59442

PTO Filter Front Filter 7720 7920
7730 7930



John Deere 7430/7530 6 Cylinder

Genuine ▼

Replacement ▼

Oil

59983

Engine Oil Filter
John Deere 6020's / 6030's



59983R

Engine Oil Filter
John Deere
6020's / 6030's



Fuel

59641

Fuel Filter John Deere 6 cyl 6030's
- Primary



59641S

Fuel Filter John Deere 6 cyl 6030's
Primary **Stanadyne Replacement**
Normal Flow 2 Micron 6.0" Length
Crinkled End



59640

Fuel Filter John Deere 6 Cyl 6030 -
Secondary



59640S

Fuel Filter John Deere 6 cyl 6030's
Secondary
Stanadyne Replacement
Reverse Flow 30 Micron 6.0" Length
Crinkled End



Hydraulic

3800

Transmission Filter John Deere
6000,10,20,30
(Short)



3800R

Transmission Filter John Deere
6000,10,20,30
(Short)



59446

Hydraulic Filter John Deere 6000
30s 4 & 6 Cylinders



59691

Hydraulic Filter John Deere - Au-
topower only Autopower=John
Deere's CVT 10,20,30's



John Deere 7730/7830/7930 6 Cylinder

Genuine ▼

Replacement ▼

Oil

59983

Engine Oil Filter
John Deere 6020's / 6030's



59983R

Engine Oil Filter
John Deere 6020's / 6030's



Fuel

59641

Fuel Filter John Deere
6 cyl 6030's - Primary



59641S

Fuel Filter John Deere 6 cyl 6030's Primary
Stanadyne Replacement Normal Flow 2 Micron 6.0" Length Crinkled End



59640

Fuel Filter John Deere 6 Cyl 6030 -
Secondary



59640S

Fuel Filter John Deere 6 cyl 6030's Secondary
Stanadyne Replacement Reverse Flow 30 Micron 6.0" Length Crinkled End



Hydraulic

59666

Hydraulic Filter John Deere 7000 7010
7020 Also 7030 Powerquad & Auto-
quad Transmission 9000T



59443

Hydraulic Filter
John Deere 7720 7920 7730 7930



59667

Hydraulic Filter John Deere 7010
20 30's
**Infinite Variable Transmission
Filter**



59442

PTO Filter Front Filter 7720 7920
7730 7930



Ball Joints



2825

Ball Joint Case Maxxum Ford 40



3144

Ball Joint Ford 8210 Carraro 4WD



6463

Ball Joint

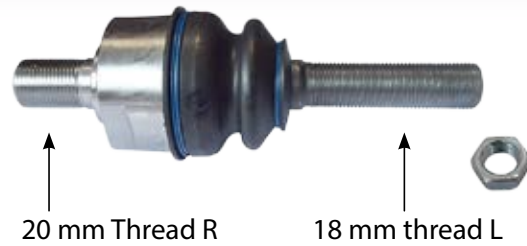

4255

Ball Joint



59960

Ball Joint



3176

Ball Joint

Ball Joints

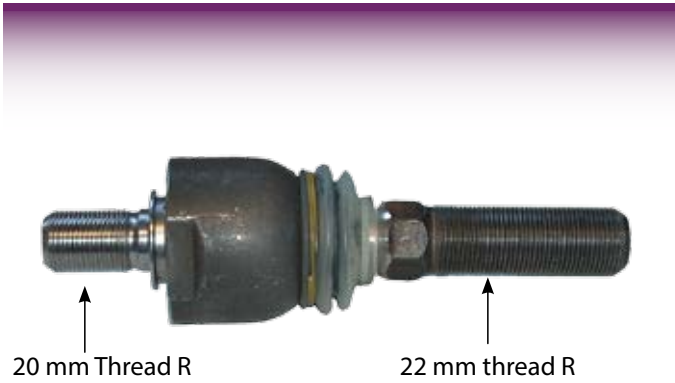

52011

Ball Joint IHC ZF 4WD

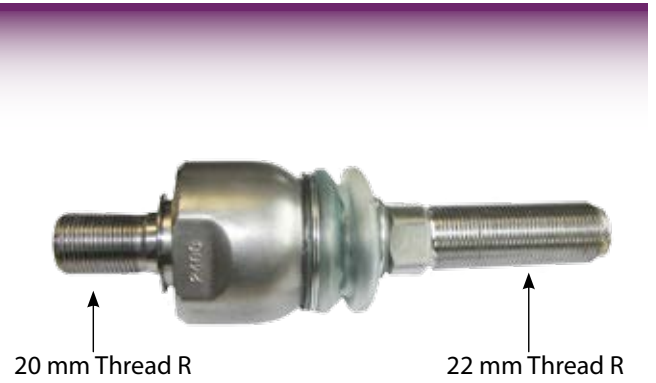

51255

Ball Joint IHC 956 1056

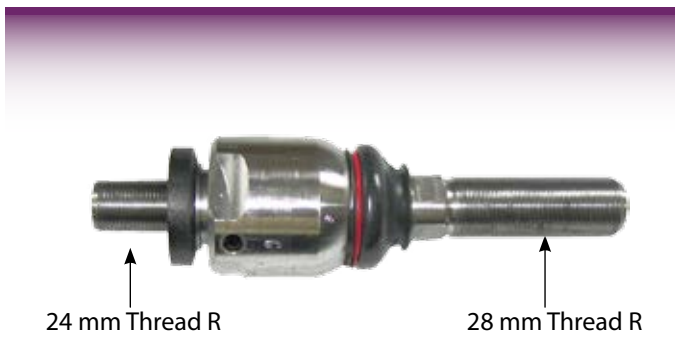

59785

Ball Joint John Deere 3040 3140 3640 3050 3350 3650 6800 6900 6810 6910 6910S 4WD 6820 6920 6920S With or Without TLS

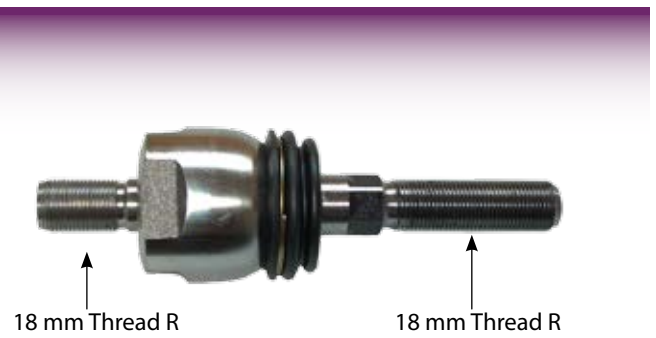

6537

Track Rod End 240 4200 362 Ball Joint Inner

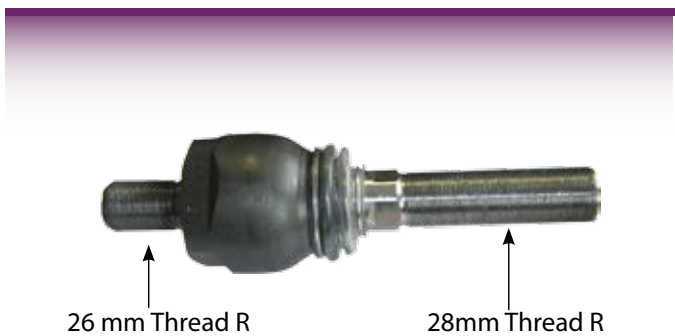

59316

Ball Joint John Deere 6520 6620 6820 6920 6520SE 6530 6530 Prem 6830 6830 Prem 6920S 6930 6930 Prem



60001

Track Rod End John Deere 7600 - 7810 4040 - 4840 7600 - 7800 4555 - 4955

Track Rod Ends

Ball Joints

59782

Track Rod End John Deere
24-2650-2850



59599

Track Rod End John Deere 2750
2950 2140 3040 3140 Steyr
9125 9145 CVT120 CVT130
CVT150 CVT170. Left Hand
[OE Ref:AR97872](#)



59598 Right Hand
[OE Ref:AL168706](#)



20 mm Thread R

18 mm Thread R

6463

300 42's - 4WD - New Type JD 2400 -
2600 - 2850 (APL325/735)

59784

Track Rod End John Deere 6800
6900 6900 6010 For 740222
APL2060 Axle



59786

Track Rod End JD 30 31 3640 30
33 3650 RH M28x1.5 For APL350
Axle **does not suit ZF APL345
axle **



59787

Track Rod End JD 30 31 3640
30 33 3650 LH M28x1.5 For
APL350 Axle **does not suit ZF
APL345 axle **



28 mm Thread R

24 mm Thread R

59785

JD 3040 3140 3640 3050 3350 3650
6800 6900 6810 6910 6910S 4WD
6820 6920 6920S With or Without TLS
APL350 M28 x 1.5

59963

Track Rod End John Deere
61/62/63/6400 LH
For APL2025 Axle



59964

Track Rod End John Deere
61/62/63/6400 RH
For APL2025 Axle



22 mm Thread R

20 mm Thread R

59960

JD 6100 6200 SE Inner
Also fits 6300 6400

Track Rod Ends

Ball Joints

59961

Track Rod End John Deere 10/20 LH For
APL2035 APL2045 Axle ** FOR 7420 7520
6520SE 6920SE - USE 59315



59962

Track Rod End John Deere 10/20 RH For
APL2035 APL2045 Axle ** FOR 7420 7520
6520SE 6920SE - USE 59315



24 mm thread R

22 mm thread R

3144

Ball Joint John Deere 10's SE RH Thread

59315

Track Rod End John Deere 6830
6930 Prem 7420 7520 6520SE
6920SE For JD740 JD745 JD750
Axle

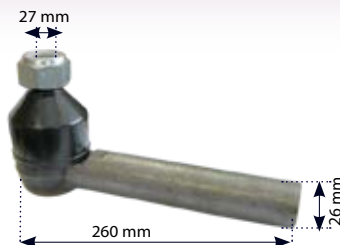

28 mm Thread R

26 mm Thread R

59316

Ball Joint John Deere 6520 6620 6820 6920
6520SE 6530 6530 Prem 6830 6830 Prem
6920S 6930 6930 Prem

59296

Track Rod John Deere 5620
5720 5820 Outer 5080R
5090R 5100R - 22mm
Thread



24 mm thread R

22 mm thread R

3144

Ball Joint John Deere 10's SE RH Thread

58670

Track Rod End John Deere 20
30 4 Cyl Outer

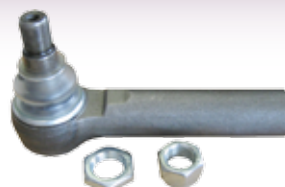

24mm Thread R

26 mm Thread R

58671

Ball Joint John Deere 20 30 4 Cyl Inner

58940

Track Rod End John Deere 6105R 6115R 6125K 6105M
6115M 6125M 6090RC 6100KC 6110RC 6090MC 6100MC
6110MC
OE Ref: AL211652



Front Axle Parts

58682

Pin John Deere Front Axle with TLS Shear Pin



59355

Front Axle Pin Soft Drive Ram 6510 6610 6810 6910 6910S 6520 6620 6820 6920 6920S Shear Pin



59588

Front Axle Pin John Deere 6000 6300 6500 6010 6020 6030 7010 7410 ** 59052 is Modified Version with Bush ** OE Ref: L111817



58994

Axle Casting Locating Pin John Deere 830 930 1030 1130 1630 1830 2030 2130 820 920 1020 1120 2020 2120 1640 1840 2040 2140 OE Ref: L34070



Pan Hard Rods

A

59335

Pin Pan Hard Rod John Deere TLS ** Pan Hard Rod is 59412 ** ** Bush is 59339 **

B

59339

Bush Pan Hard Rod John Deere 6010 6020 4WD 6010 - 6910 6020 - 6920 Suspension

C

59412

Pan Hard Rod John Deere 6010 - 6020 4WD 6010 - 6910 & 6020 - 6920 Suspension **For Front Axle**BUSH IS 59339**

CA

59053

Pan Hard Rod John Deere 7720 7820 7920 7630 7730 7830 7930

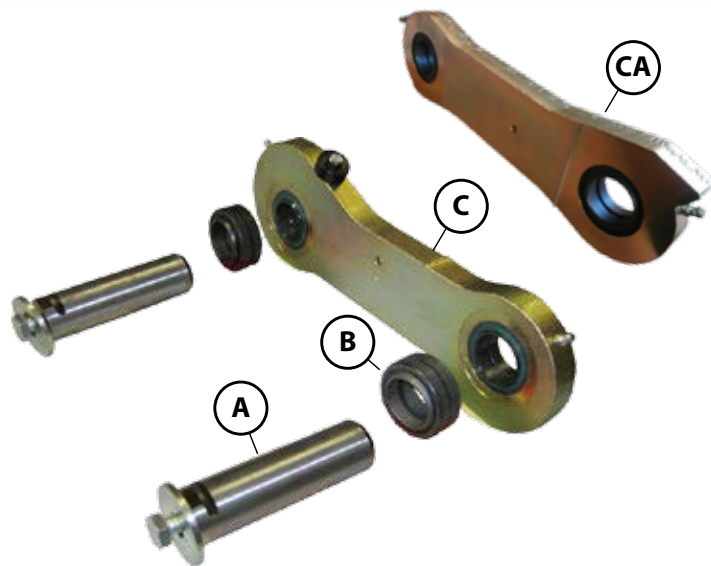

58898

Sensor Axle Position John Deere 10 Series 20 Series 30 Series R Series M Series
OE Ref: AL113843



Axle - Transmission Parts

Wheel Hubs



59304
Oil Seal Front wheel hub
John Deere 20 30 40

2499
Wheel Hub John Deere
1020 2140 Front

Oil Seal= 59304



59363
Wheel Hub John Deere
3020 4020 1520 2520 4030
4230

Oil Seal= 59304



2497
Wheel Hub John
Deere 3120 3350
Front

Oil Seal= 59304



4960



U Joint Ford TW5 TW15 TW25 -
34 x 97mm

59055

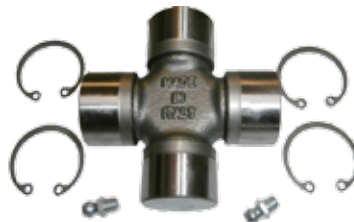

Universal Joint John Deere 2140 2850
6100 6200 6300 6400 6010 6110 6210
6310 6410 6020 6120 6220 6320 6420
Fendt 304 307 308 309 310

28 x 71.5mm

59033



Universal Joint John Deere 1840 2040
2850 3040 3350 3640 6820 6920 6930
7530 Case 1046 1246 1255 35mm x 97mm

Front Hub Seals

59854

Front Axle Hub Seal John Deere
6520-6920 6520-6920
Size 95 x 70 x 13/14.5



59855

Front Axle Hub Seal John Deere
6820 6920
Size: 180 mm 150 mm 14.5 / 16 mm



58669

Hub Seal Inner John Deere 00 10 20
Series 4 Cylinder

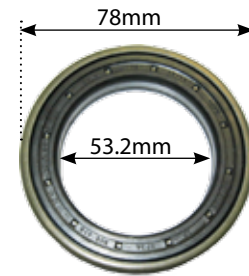

59827

Hub Seal John Deere Front Axle
3050 3350 3650
Size: 138 x 165 x 13.5



4161

Axle Seal ZF Ford APL345
Size: 46 x 65 x 15.7



59269

Seal Front Axle John Deere
6000 Series



59257

Hub Seal John Deere 6100 6200 6300
6400 6110 - 6410 6020 - 6620SE 6020 -
6420SE Prem
Size: 150x178x13

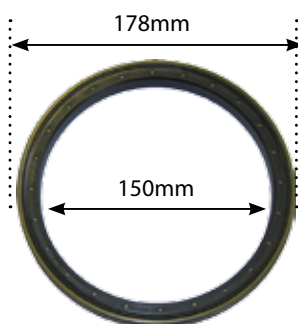

59268

Plate Seal Front Axle John Deere
6000 Series 4WD
Size: 41x72x3.5

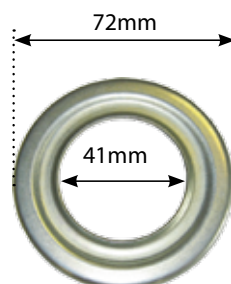

58856

Axle Seal John Deere 6010 6020 6100
6110 6120 6200 6210 6220 6300 6310
6320 6400 6410 6420 6506 6600 6800
Fendt 304 307 308 309 [OE Ref: AL79902](#)

Size 48.7 mm, 67.8 mm, 13.7 mm



Front Axle Bushing



59864
Front Axle Main Pivot Bush
John Deere**2 Per Tractor**

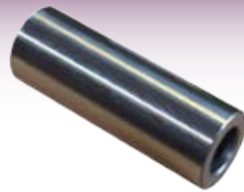

58993
Bushing Front Axle 4WD John Deere 1020 2020 2030
2630 2440 2640 2040 2240 1640 1840 1830 2030 2130
1020 1120 830 930 1030 1130 1630
OE Ref: T21669

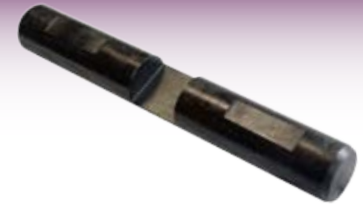

58995
Shaft Differential Bevel Gear John Deere
1530 1830 2030 2130 940 1040 1140 1640
1840 2040 2140 3040 3140 3640 3050 3350
2650 2850 2250
OE Ref: L29226

Steering Worm Guide

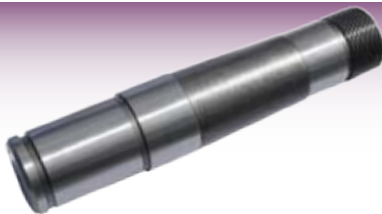

58997
Pin Front Axle Top Arm
John Deere 1640 1840
2040 OE Ref: AL31088



59075
Steering Worm Guide As-
sembly John Deere 6100
6200 6400

Steering Pivot Pins

3226

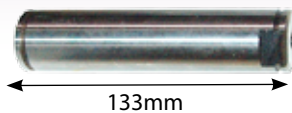

Steering Pivot Pin John Deere 133mm

3263

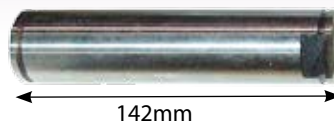

Steering Pivot Pin John Deere
2030 2130

3243



Steering Pivot Pin John Deere
3030/3130

ZF Axle Shaft

4048

ZF Axle Shaft Ford 10
John Deere 2040 - 2650 & Case



Gear

4563

Gear Ford 10 & John Deere 2040 - 2650



Axle Parts

APL2060

<p>59141</p> <p>King Pin APL2060 John Deere 6800 6900 10 20</p> <p>Bearing = M86649/10</p>	<p>59140</p> <p>Pivot Housing APL2060 RH John Deere 6800 6900 10 20</p>	<p>59139</p> <p>Pivot Housing APL2060 LH John Deere 6800 6900 10 20</p>	<p>59138</p> <p>Carrier Housing APL2060 John Deere 6800 6900 10 20</p>
---	--	--	---

<p>59144</p> <p>King Pin APL2045 Axle John Deere Deutz</p> <p>Bearing = M86649/10</p>	<p>59041</p> <p>Axle Pivot John Deere 8100 8200 8300 8400 8110 8210 8310 8410 8120 8220 8320 8420 8520 8130 8230 8330 8430 8225R 8235R 8245R 8266R</p> <p>Bearing = 59047</p>
--	--

<p>58862</p> <p>Axle Pivot Joint APL 2045 2060 John Deere 6506 6600 6800 6900 6510 6610 6810 6910 6910S 6520 6620 6820 6920 6920S 6320SE 6420SE</p> <p>Bearing = M86649/10</p> <p>OE Ref: L101718</p>	<p>58861</p> <p>Axle Pivot Joint John Deere 6100 6100SE 6200 6200SE 6300 6300SF 6400 6400SE 6010 6010SE 6110 6110SE 6210 6210SE 6310 6310SE 6410</p> <p>OE Ref: T188397</p>
--	--

<p>59052</p> <p>Pin & Bush Main Frame John Deere 6100 6200 6300 6400 6600 6800 6900 6110 6210 6310 6410 6510 6610 6810 6910 6205 6505 6020 6120 6220 6320 6420 6520 6620 6820 6920 6215 6515 6130</p>	<p>59047</p> <p>Bearing Cup John Deere 8100 8200 8300 8400 8110 8210 8310 8410 8120 8220 8320 8420 8520 8130 8230 8330 8430 8235R 8245R 8260R 8270R</p>
--	--

<p>42982</p> <p>Front Axle Joint Assembly APL335 Ford 7610</p>	<p>59135</p> <p>Planet Carrier APL735 John Deere 2650 2850</p>
---	---

Axle Parts

APL3052

59134



King Pin APL3052
3054 John Deere
Case Ford

59132



Pivot Housing
APL3052 - 3054 LH
John Deere

59133



Pivot Housing
APL3052 - 3054
RH John Deere

APL345-350

42979



Pivot Housing APL345-350 RH
Ford Case

42980



Pivot Housing APL345-350 LH
Ford Case

59145



Pivot Housing APL345 350 RH
John Deere 3040 3140 3050
3350

59146



Pivot Housing APL345 350 LH
John Deere 3040 3140 3050
3350

APL1551/1552/1251/1351

59149



Carrier Housing
APL1551-1552 John
Deere Case

42988



Pivot Housing APL1351
- APL1251 LH

59150



Pivot Housing
APL1351-APL1251 RH

41204



King Pin Stub Axle
Ford 5600 6700 ZF
4WD

59151



King Pin 2140 3050
APL325 John Deere

Bearing = 84548/10

Axle Parts

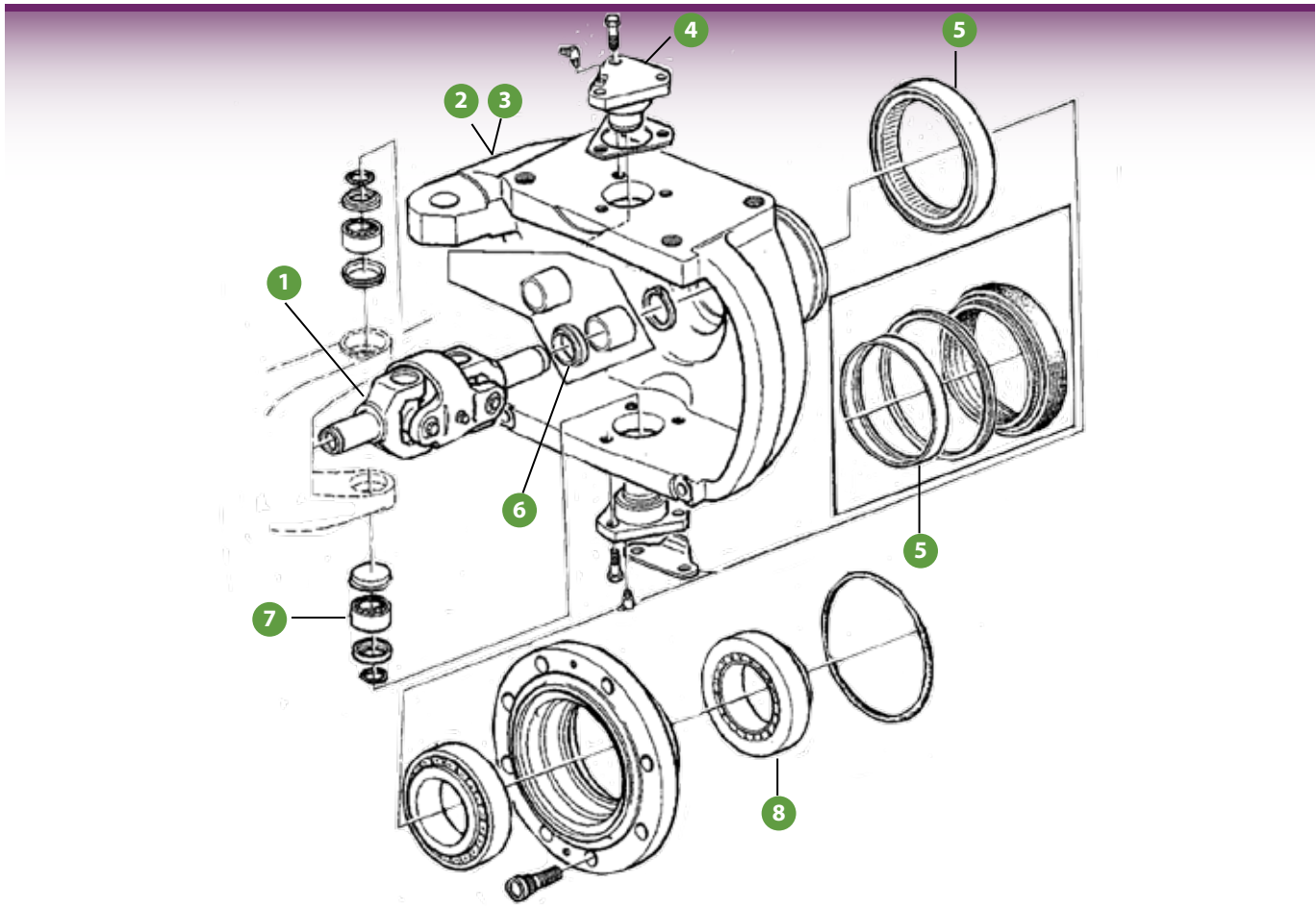

1 59142

Front Axle Joint Assembly
APL735 John Deere 50 40



2 59136

Pivot Housing APL735 RH
John Deere 2650 2850



3 59137

Pivot Housing APL735 LH John Deere
2650 2850

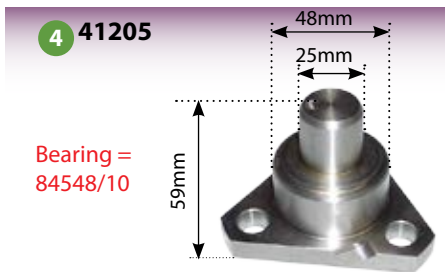

4 41205

Bearing =
84548/10

Stub Axle Ford 5610 6610 6810 ZF
IHC JD 4WD 6410 7610 JD 2850



5 4064

Axle Seal Ford APL325 APL330
APL335 ID 121.5 - OD 150 - H 12.8

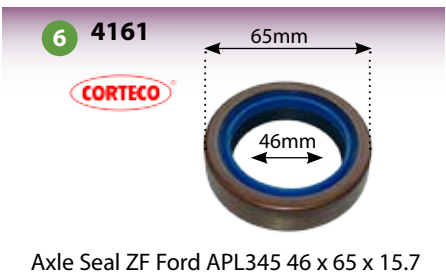

6 4161

Axle Seal ZF Ford APL345 46 x 65 x 15.7
OE Ref: 81288C1

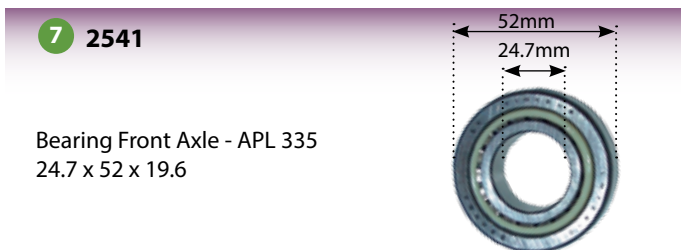

7 2541

Bearing Front Axle - APL 335
24.7 x 52 x 19.6

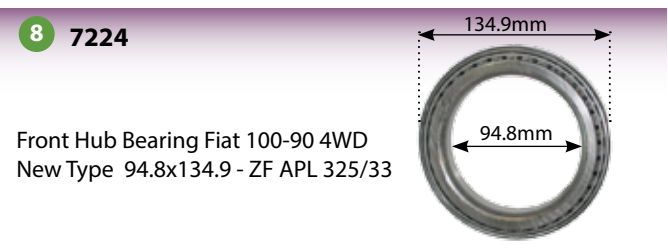

8 7224

Front Hub Bearing Fiat 100-90 4WD
New Type 94.8x134.9 - ZF APL 325/33

Axle Parts

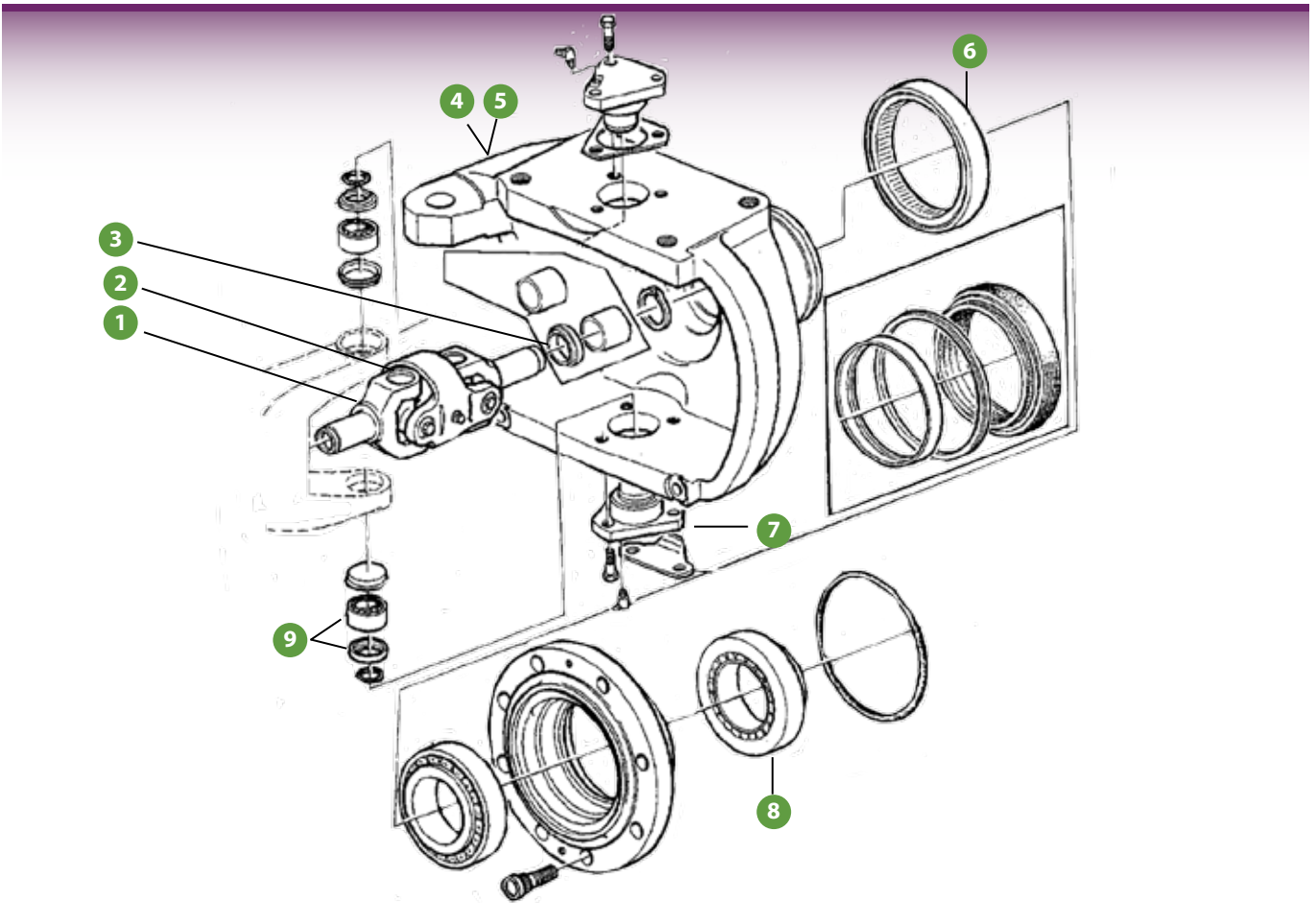

1 59143



Front Axle Joint Assembly
APL345 350 John Deere 40 50
Ford TW 8210

2 2855

U Joint ZF APL 345
4WD Axle 30.2 x 82mm
Massey Ferguson 3095
3120 3125 3635 3645
3655 3670 3690 6170
6180 6190 6270 6280
30.2mm x 82mm

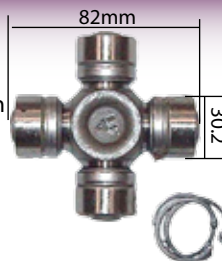

3 4161

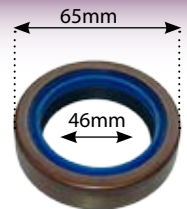

Axle Seal ZF Ford APL345 46 x 65 x 15.7
OE Ref: 81288C1

4 59148



Pivot Housing APL315 315N 325 325N
LH John Deere Case

5 59147



Pivot Housing APL315 315N 325 325N
RH John Deere Case

6 59827

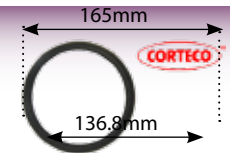

Hub Seal John Deere
Front Axle
136.8 x 165 x 13.5

7 41206

Bearing =
84548/10

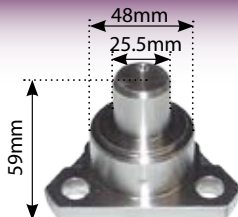

Stub Axle Ford ZF IHC JD 4WD 7610
7710 7910 8210 TW 5 / 15 / 25 Case 956
1056 JD 3050 3350 3650

8 2314

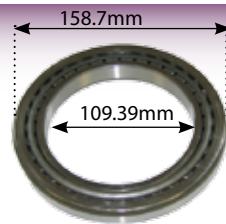

Bearing Front Axle Carraro ZF APL 345
158.7x109.39

9 84548/10



Stub Axle Bearing

Orbital Units

<p>1447</p> <p>Orbital Unit 300 3000 - 100 OSP **Note M18 for Hyd Pipes**</p> 	<p>6907</p> <p>Orbital Unit 300 3000 125 OSP M18 Thread **Note M18 holes for Hyd Pipes**</p> 
<p>4655</p> <p>Orbital Unit c/o Relief Valve 3/4 JIC 100 OSP</p> 	<p>4564</p> <p>Orbital Unit Seal Kit to Suit 4655</p> 
<p>51051</p> <p>Orbital Unit 200 OSP 3/4 JIC</p> 	<p>4605</p> <p>Orbital Unit Ford 40 TS 4WD M18 -12 Spline 24.25mm Diameter 20mm high 150 OSP</p> 
<p>52184</p> <p>Orbital Unit Case MXU Puma JX JXU Maxxum Ford 35 60 TL L M T TL Series TLA TM TSA TSA Series STZOR125M170 175 OSP</p> 	<p>4857</p> <p>Orbital Unit John Deere 160 OSP (40 Series)</p> 
<p>1504266</p> <p>Orbital Unit Repair Kit IHC Massey Ferguson</p> 	<p>7808</p> <p>Orbital Unit Fiat 56 88 90 93 94 Series 100 OSP 1/2" BSP</p> 
<p>1810503</p> <p>Orbital Unit Repair Kit</p> 	<p>4620</p> <p>Orbital Unit Fiat 2 Ram Axle 160 OSP 1/2BSP Also fits Zetor</p> 
<p>59049</p> <p>Transmission Shaft John Deere 1640 1840 2040 3040 3140 3340 3640 3640S 2250 2250F 2650 2450F 2650F 2850 3050 3150 3350</p> 	<p>59048</p> <p>Levelling Yoke Short John Deere 3640 3640S 2250 2250F 2450 2650 2450F 2650F 2850 3050 3150 3350</p> 
<p>4600</p> <p>Steering Column Assembly Hydrostatic 830mm</p> 	<p>62292</p> <p>Orbital Unit Fitting Kit 675 -698 French Type **2 x Screw & 4 x O Ring** 575 - 590</p> 
<p>59045</p> <p>Cylinder Rod John Deere 7200 7400 7600 7700 7800 7210 7410 7510 7610 7710 7810 8100 8200 8300 8400</p> 	<p>59046</p> <p>Cylinder Rod Repair Kit John Deere</p> 

Tractor Seats

4901

Seat John Deere Tractor



59769

Seat John Deere Gator



59129

Seat Cover John Deere 00 Series Mechanical Seat

OE Ref: [MCJHD1110](#)

58827

Passenger Seat John Deere 5000s
OE Ref: [LVB25717](#)



2195

Arm Rest Grammer Seat RH Landini John Deere



59267

Seat Cover John Deere 5020 After 2007 6000 6010 6020 Air Seat

OE Ref: [MCJHD1729](#)

59251

Seat Cover John Deere 5820 6020 6010 6030 7430 7530SE 5020 Series Up To 2007 Mechanical Seat

OE Ref: [MCJHD1730](#)



59115

Seat Belt Mounting Bracket John Deere



59032

Seat Holder John Deere SE6010 SE6210 SE6310 SE6410

OE Ref: [AL120003](#)



59071

Seat Belt Kit John Deere Passenger Seat

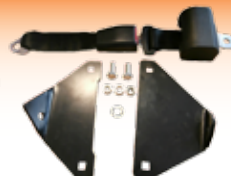

59902

Seat Passenger John Deere **
Seat Belt Mounting Kit is 59071
** ** Seat Belt is 51806 ** Brackets are 59115 *



58892

Handle Kit Passenger Seat John Deere



51806

Seat Belt Automatic 2 Points



59565

Seat John Deere 8110 8210 Passenger 8310 8410 8120 8220 8320 8420 8520 7720 7820 7920 8110T 8210T

Oe Ref: [RE192707](#)



59564

Seat Back John Deere 8110 8210 Passenger 8310 8410 8120 8220 8320 8420 8520 7720 7820 7920 8110T

Oe Ref: [RE168331](#)



59563

Seat Bottom John Deere 8110 Passenger 8210 8310 8410 8120 8220 8320 8420 8520 7720 7820 7920 8110T

Oe Ref: [RE312760](#)



Decal Kits

58793

Decal Kit 3050 OE Ref: L59278



58792

Decal Kit 3040 OE Ref: L35211



59674

Decal Kit John Deere 6400



59673

Decal Kit John Deere 6600



59672

Decal Kit John Deere 6800



59671

Decal Kit John Deere 6900



59227

Decal John Deere SE 6100 6200
6300 6400 6010 6110 6210 6310
6410 6510 6610 LH



59226

Decal John Deere SE 6100 6200
6300 6400 6010 6110 6210 6310
6410 6510 6610 RH



53680
Decal
30kmph



53681
Decal
40kmph



53682
Decal
50kmph



53683
Decal
60kmph



Decal Kits

58954

Decal Kit John Deere **6210**
 OE Ref: L113596



58955

Decal Kit John Deere **6310**
 OE Ref: L113598

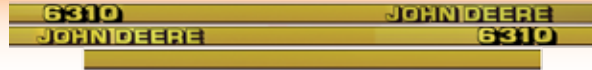

59416

Decal Kit John Deere **6410**



59415

Decal Kit John Deere **6610**



59414

Decal Kit John Deere **6810**



59413

Decal Kit John Deere **6910**



59559

Decal Kit John Deere **6320**
 OE Ref: L153869 + L153870



59247

Decal Kit John Deere **6420**



59246

Decal Kit John Deere **6820**



SG 2 Cab Parts

Cab Glass

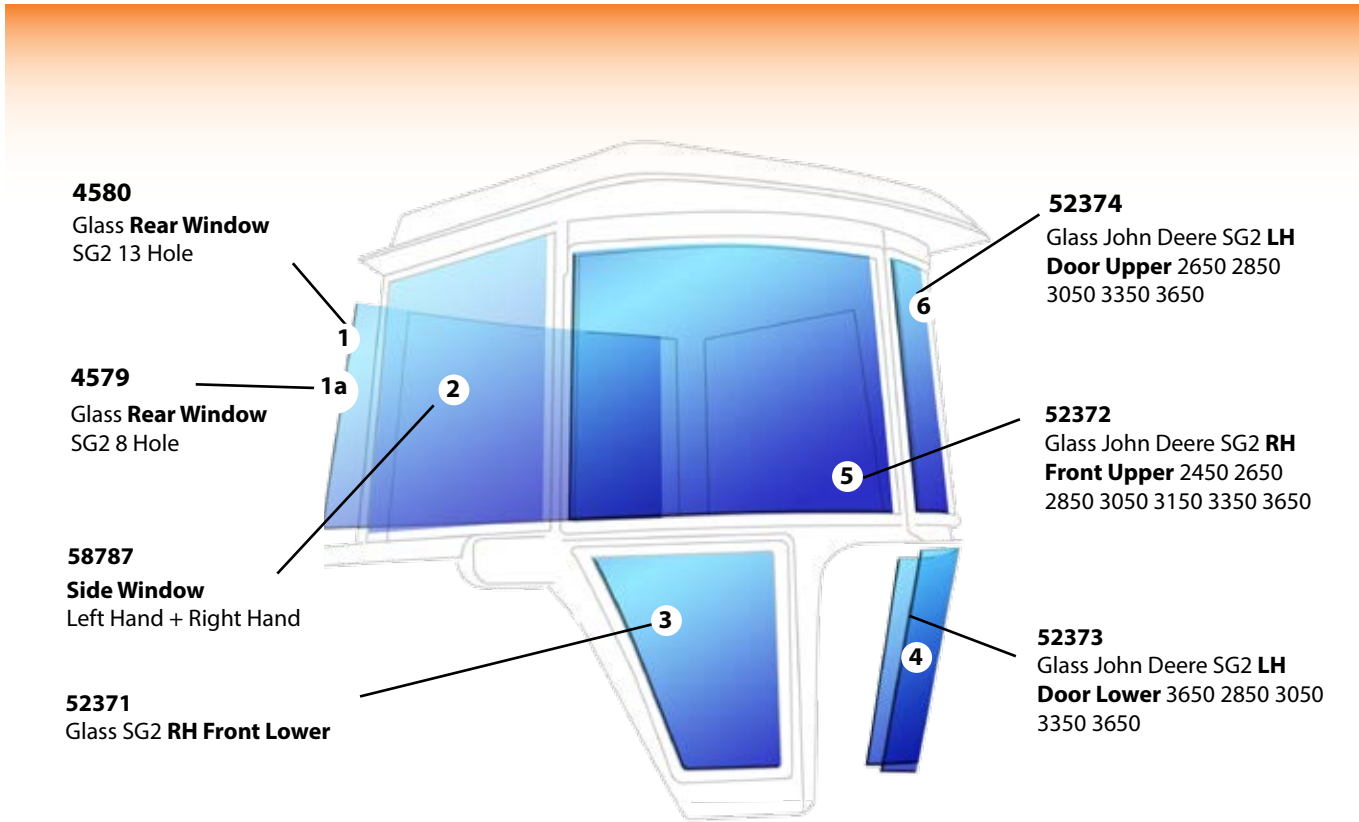

SG 2 Cab Parts



Gas Strut John Deere 40/50's - Rear Window (150N) (SG2 Cab) Length 735mm - Ram 324mm



Wiper Blade John Deere 50's SG2 Cab



Fan Cab Blower John Deere 40 50 10 SG2 Cab 11 Series Combine SG2 Cab



Door Handle John Deere 940 1040 1140 1640 1840 2040 2140 1030 1130 1630 1830 2030 2130 3030 3040 3130 3140 4050 4240 4440 4650 4630 4430 4840 SG2 Cabs LH RH

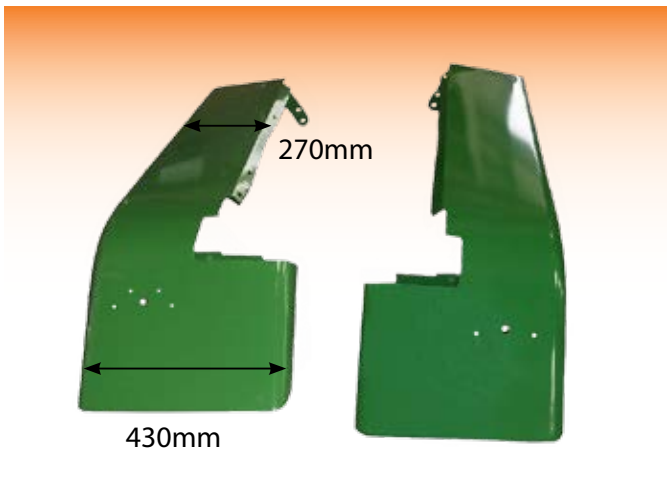

59600
Mudguard Kit John Deere SG2 430mm PAIR
** Narrow Mudguard **** 59601 is 490mm PAIR **

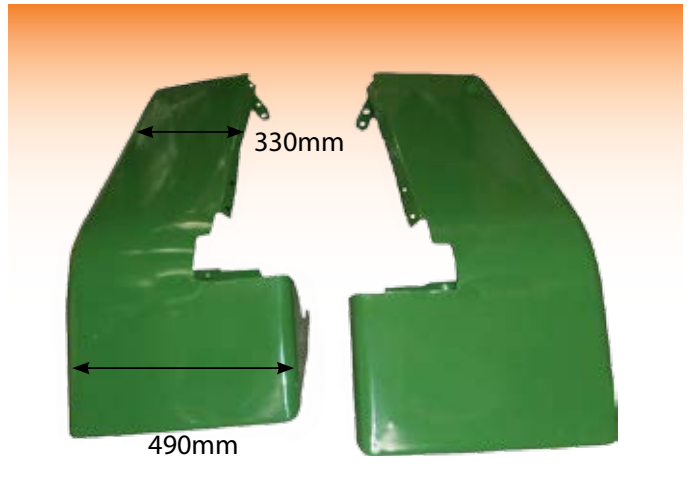

59601
Mudguard Kit John Deere SG2 490mm PAIR ** Wide Mudguard **** 59600 is 430mm PAIR **

Foot Steps & Components - 6010 , 6020 , 6030 Series

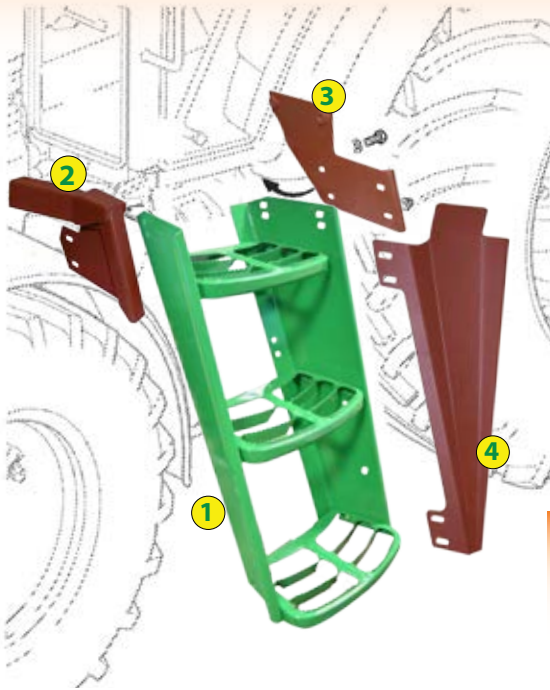

1	59941	Foot Step 6600 6800 6900 - 3 Step Left Hand/Right Hand - OE Ref: AL82365
2	59583	Front Foot Step Bracket - Left Hand - OE Ref: AL154750
	59582	Front Foot Step Bracket - Right Hand - OE Ref: AL154749
3	59580	Rear Foot Step bracket - Left Hand - OE Ref: AL180272
	59581	Rear Foot Step bracket - Right Hand - OE Ref: AL180273
4	59579	Foot Step to Mudguard Panel - Left Hand - OE Ref: L111349
	59578	Foot Step to Mudguard Panel - Right Hand - OE Ref: L111351

59995

Foot Step John
Deere 6000 6010
4 Cyl - 2 Step



59980

Foot Step John Deere Bolt On



Front Grill & Lamps - 6 Cyl - 30 Series & 20 Series Premium

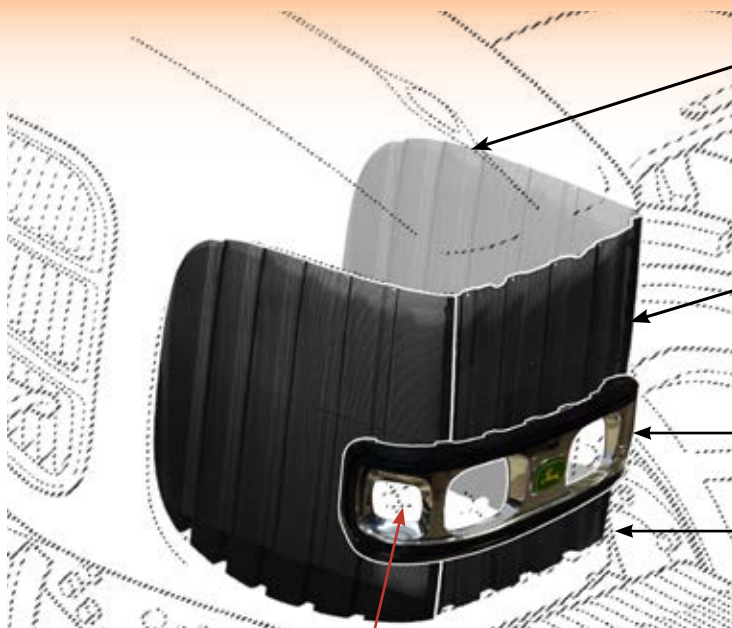

59103

Front Grill John Deere 6520 6620 6820
6920 6530 6630 6830 6930 LH

59104

Front Grill John Deere 6520 6620 6820
6920 6530 6630 6830 6930 RH

59101

Front Grill Middle Upper John Deere 6520
6620 6820 6920 6530 6630 6830 6930

59186

Head Lamp Frame John Deere 30s Premium

59102

Front Grill Middle Lower John Deere 6520
6620 6820 6920 6530 6630 6830 6930

58966

Front Work Lamp John
Deere 30s Premium OE
Ref: AL173620

58967

Bulb for 58966
OE Ref: 57M9328



59303

Glass Head Lamp Frame John Deere 30s
Premium



Front Grill 4 Cyl - 6020 , 6030 Series

58901

Front Grill Upper John Deere 6020 6120
6220 6320 6420 6420S 6215 6515 6130
6230 6330 6430 6225 6325 6425 OE Ref: L157398

58903

Side Grill John Deere 6020 6120
6220 6320 6420 6215 6515 6130
6230 6330 6430 6225 6325 6425
RIGHT HAND OE Ref: L155185

58900

Front Grill Lower John Deere 6020 6120 6220
6320 6420 6420S 6215 6515 6130 6230 6330
6430 6225 6325 6425 OE Ref: L155181



58902

Side Grill LEFT HAND
OE Ref: L155184

58824

Head Lamp Surround John
Deere 20 Series 30 Series OE
Ref: L116524

Nose Cone

4325

Nose Cone John Deere 1030
1130 2030 2130



Side Grill

59998

Grill John Deere 1630 2030 2130
Side



Battery Trays

59585

Battery Tray John Deere
SE6510 SE6610 6205 6505
6800 6900 OE Ref: AL79635
AL118522



59584

Battery Tray John Deere 6310
6410 6110 6210 6310 6410 SE6010
SE6110 SE6210 SE6310 SE6410
6205 6505 SE6100 SE6200 SE6300
SE6400
OE Ref: AL112808 AL118561



Foam

59124



Cladding John Deere 6010 LH
Panel Foam

59503



Sun Roof Foam John Deere 6000 6010

59474



Dash Cover Foam John Deere 50

59504

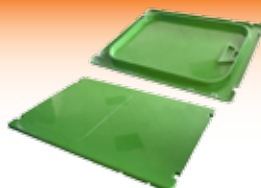

Sun Roof John Deere 6000 6010 6020 6030 6100 6900 6110 6910
6020 6920 6030 6930 7430 7530 1200mm x 860mm

59360



Recess Sunroof Handle John
Deere 6000 Series

Mudguard Flaps

Tractor Mudguard Flaps Sold as Pairs



Note: All measurements are +/- 15mm due to the nature of manufacturing process

2969	A: 350 mm, B: 1000mm
402947	A: 380 mm, B: 1140mm
402948	A: 480 mm, B: 1160mm
2436	A: 320 mm, B: 960mm
2968	A: 400 mm, B: 1225mm
2959	A: 540mm, B: 1320mm
2960	A: 600mm, B: 1340mm

62811

Mudguard Kit Universal
4WD 400mm Flaps ** 63136
is Adaptor Plate **



51719

Mudguard Spacer
40mm



63136

Conversion Plate Mudguard
Mounting Bracket ZF Side Drive
Case MF Carraro 709



Mudguard & Mudguard Extensions

59916



Mudguard Extension John Deere 6000,10 LH ** RH is 59991 with Number Plate Lamp Hole ** ** RH is 59710 without Number Plate Lamp Hole

59991



Number Plate Slot Lamp Slot

Mudguard Extension John Deere 6000, 10 RH ** Slot for Number Plate + Lamp Hole **

59006

Mudguard John Deere 6000 - 6900 6010 - 6910 SE Only
Pair
OE Ref: RE286515



59710

Mudguard Extension John Deere 6000,10 RH
**** Number Plate Slot ****
Does Not Have Lamp Hole



59518

Mudguard John Deere 4240s Cab LH
4040 - 4840 4050 - 4850 Series

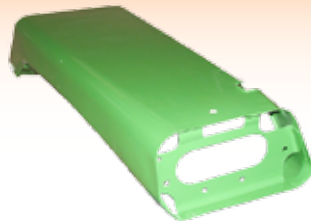

59517

4240s Cab Right Hand Mudguard

59549

Surround Mudguard Lamps John Deere 2140 3040 3140 3050 3350 2650 2850 ** Mudguards are 59518 & 59517 **
OE Ref: R81696 + R81697

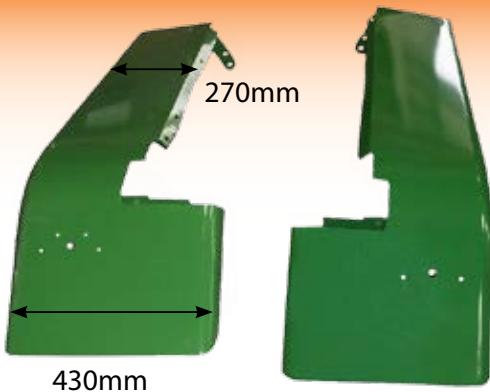

59600

Mudguard Kit John Deere SG2 430mm PAIR
** Narrow Mudguard **** 59601 is 490mm PAIR **

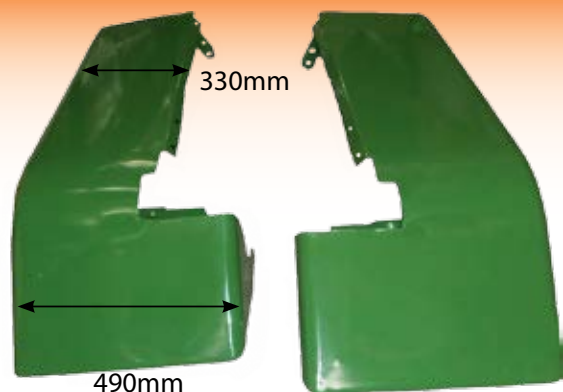

59601

Mudguard Kit John Deere SG2 490mm PAIR ** Wide Mudguard **** 59600 is 430mm PAIR **

Mirrors and Arms

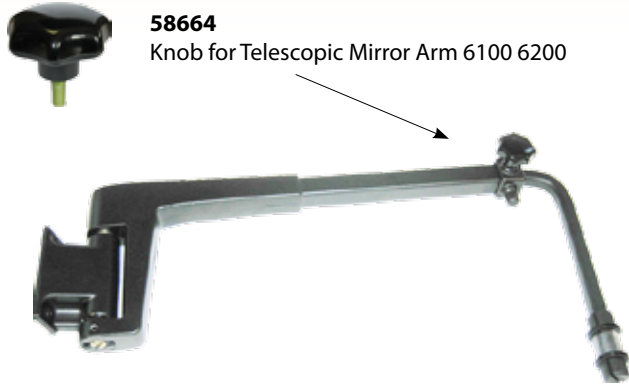

59796
Left Hand

59800
Right Hand

Telescopic Mirror Arm
John Deere
10 20 6000'

59901
Rear View Mirror John
Deere 10 20 6000



59901GL
Rear View Mirror Glass John Deere
10 20 60 - PAIR 281 x 201 mm



Mirrors and Arms



59009
Mirror Arm John Deere 40s 50s LH



59010
Mirror Arm John Deere 40s 50s RH



59011
Mirror John Deere 40s 50s Rear View

59797
Left Hand

59903
Right Hand

Mirror Arm Kit (Telescopic)
JD 6000 Series



6399001
Left Hand

6399000
Right Hand

Complete Mirror
(225x312mm)



6398025
Mirror Replacement



Gas Struts

Note:

Check newton rating of existing gas strut before ordering a replacement.
Using a gas strut with a lower or higher newton rating can result in damage or glass breakage.

59952



Application	Models	Force (N)	Length (mm)	Ram (mm)	OE Ref
Steering column	5020 Series 6000 Series 6010 Series 6020 SE Series 6020 Series 6030 Series 5R Series	330	230	65	AL150755

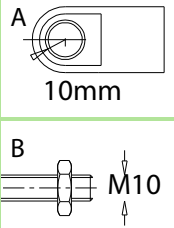

59663



Application	Models	Force (N)	Length (mm)	Ram (mm)	OE Ref
Door	6000 Series 6010 Series	250	260	90	AL110629

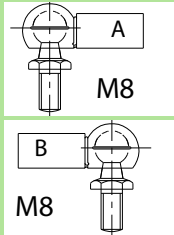

59664



Application	Models	Force (N)	Length (mm)	Ram (mm)	OE Ref
Door	5020 Series 6030 Series 7030 Series 6030 Premium Series 5025 Series 7030 Premium Series	350	245	70	AL174358

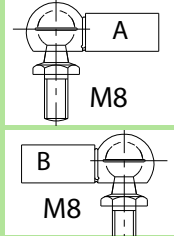

1514



Application	Models	Force (N)	Length (mm)	Ram (mm)	OE Ref
Rear window	40 Series	150	730	320	AL33170

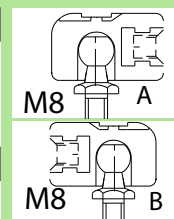

59821



Application	Models	Force (N)	Length (mm)	Ram (mm)	OE Ref
Rear window	50 Series 40 Series	150	735	324	AL35675

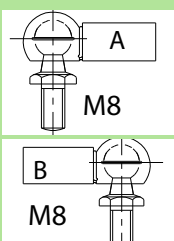

59818



Application	Models	Force (N)	Length (mm)	Ram (mm)	OE Ref
Rear window	40 Series	200	495	205	AL33170

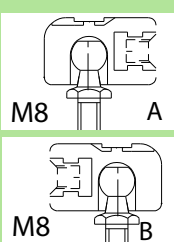







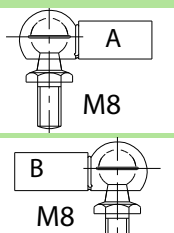

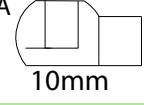
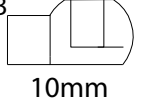

59371

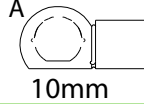
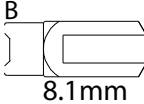

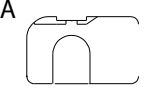
Application	Models	Force (N)	Length (mm)	Ram (mm)	OE Ref
Rear window	6000 Series 6010 Series 6020 Series 6030 Series	130	500	195	AL114803

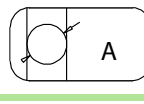
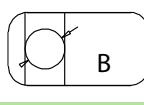

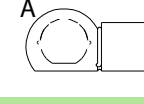
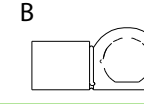
Gas Struts

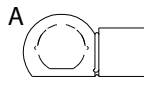
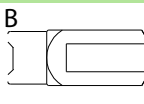
 <p>59079</p>	Application	Models			 <p>A 10mm</p>
	Sun roof	6000 Series 6010 Series 6020 Series 6030 Series 7030 Series			
	Force (N)	Length (mm)	Ram (mm)	OE Ref	 <p>B 10mm</p>
200	515	220	AL160699		
 <p>59770</p>	Application	Models			 <p>A 10mm</p>
	Bonnet	6000 Series 6010 SE Series 6010 Series			
	Force (N)	Length (mm)	Ram (mm)	OE Ref	 <p>B 8.1mm</p>
900	355	105	AL77767		
 <p>59069</p>	Application	Models			 <p>A</p>
	Bonnet	6020 Series 6030 Series 6025 Series			
	Force (N)	Length (mm)	Ram (mm)	OE Ref	 <p>B</p>
510	550	205	AL174088		
 <p>59078</p>	Application	Models			 <p>A</p>
	Bonnet	6020 Series 6030 Series 7030 Series			
	Force (N)	Length (mm)	Ram (mm)	OE Ref	 <p>B</p>
800	545	190	AL174087		
 <p>58904</p>	Application	Models			 <p>A</p>
	Bonnet	6130R 6140R 6145R 6150R 6155R 6175R 6195R 6215R 6130M 6135M 6140M 6145M 6150M 6155M 6170M 6175M			
	Force (N)	Length (mm)	Ram (mm)	OE Ref	 <p>B</p>
750	620	250	AL215748		
 <p>58905</p>	Application	Models			 <p>A</p>
	Bonnet	6105R 6110R 6115R 6120R 6125R 6130R			
	Force (N)	Length (mm)	Ram (mm)	OE Ref	 <p>B</p>
825	710	315	AL214868		

3943

8-18 Steel Eye for Gas Struts - All Gas Strut Except 300's Door



3942

Ball Joint 8-18 Steel - All Gas Strut Except 300 Series Door



TRACTOR PAINT

Hand brush or spray
Hardens to an OEM Finish
No colour variance

PLEASE NOTE:
Use QTP Thinners Only.
Follow directions on tin.

For a Professional Finish

1 Choose Paint
Spray or Brush

Choose
From a wide
range of colours

2 TR1488
1 Ltr Thinners

Mixing Ratio
Paint : Thinners
9:1 or 10:1

3 TR7000
1 Ltr Clear
Lacquer

Tough
Durable &
easy to use



MASSEY FERGUSON

- 1200TR** 35 4 Cylinder Gold
- TR1001** 35 4 Cylinder Red
- TR1180** 35X Ferguson Grey
- TR1187** Massey Ferguson Red
- TR1181** MF 100s Silver Mist
- TR1265** Massey Ferguson Flint Grey
- TR1399** Stoneleigh Grey
- TR1116** Transmission Brown / Charcoal Grey
- TR1000** 42 Series Chassis Black
- TR1002** Massey Ferguson 42 54 Red (New Red)
- TR1004** 42 Series Silver Mist
- TR1179** Smoke Grey
- TR1222** NH Driveline Grey - New Cab
- TR1225** Massey Ferguson Light Grey Pain
- 1191TR** Light Grey

RENAULT

- TR6615** Renault Grey
- TR6611** Renault Orange

SAME

- TR5501** Same Blue

FORD

- TR2440** Fordson Empire Blue
- TR3488** Fordson Orange
- TR1182** Ford Tractor Blue
- TR6616** New Holland Chassis Grey
- TR1071** Ford Grey
- TR1196** New Holland Ford Blue
- TR1221** New Holland Grey White for Wheels

FIAT

- TR3130** Fiat Brown
- TR3487** Fiat Opal White
- TR4188** Fiat Terracotta Brown
- TR3131** Fiat Orange
- TR3132** Fiat Cream

JOHN DEERE

- TR1162** John Deere Green
- TR2134** John Deere Yellow

LANDINI

- TR1065** Landini Blue

FENDT

- TR1060** Fendt Green

53208
Grey Primer
Wheel Spray
500ml Can



53207
Silver Paint
Wheel Spray
500ml Can



53210
Black Paint
Wheel Spray
500ml Can



53209
High Gloss
Black Paint
Wheel Spray
500ml Can



TRACTOR PAINT

Hand brush or spray
Hardens to an OEM Finish
No colour variance

PLEASE NOTE:
Use QTP Thinners Only.
Follow directions on tin.

For a Professional Finish

TR1156



1 Litre
Red Oxide Primer

TR2397



1 Litre
Buff Primer Undercoat

TR1955



1 Litre
Grey Primer Undercoat

IHC/DAVID BROWN

- TR1163** IHC Off-White Wheels
- TR1231** International Red
- TR4703** Case/IHC Red New Red
- TR3489** David Brown Hunter Pink
- TR1184** David Brown Orchid White
- TR1184A** David Brown Power Red

Deutz

- TR6617** Deuta Green
- TR6618** Deuta Green

ZETOR

- TR1193** Zetor Grey
- TR1183** Zetor Red
- TR1189** Zetor Chassis Green

LEYLAND

- TR1190** Leyland Light Blue
- TR1190A** IHC / Leyland Dark Blue

WHITE/BLACK

- TR2175** Matt Black
- TR1109** Gloss Black
- TR1420** White

INDUSTRIAL

- TR1520** Old Hitachi Orange
- TR1003** New Hitachi Zaxis Orange
- TR1185** Industrial Yellow
- TR1198** New JCB Yellow
- TR1115** New Holland Clayson Yellow
- TR1160** New Ford Yellow
- TR1192** Komatsu Yellow
- TR1194** New Holland Yellow
- TR1195** Senator Lime Green
- TR1253** Rotavator Orange
- TR2393** Case Brown
- TR2396** New Cat Yellow
- TR2401** Case Tan
- TR2447** Kvernland Green
- TR3684** Land Rover Blue



59633
JD Green Spray
Can Aerosol
400ml

59623
JD Yellow Spray
Can Aerosol
400ml

NUFFIELD

- TR3490** Nuffield Orange/Red

Date:.....

No. of Pages:.....

Name of the Rep.....

A/C Number:.....

From:.....

e-mail.....

Phone No.:.....

Fax No.:.....

Please quote for the following parts - Quotation Number :

I wish to confirm the following order on Quotation Number:

Please supply the following parts:

Please photocopy this page

Please do not remove this page

	Qty	Part No.	Description	Unit Price
1.				
2.				
3.				
4.				
5.				
6.				
7.				
8.				
9.				
10.				
11.				
12.				
13.				
14.				
15.				
16.				
17.				
18.				
19.				
20.				
21.				
22.				
23.				
24.				

Comments:

Customer Signature:

Rep's Signature:

Tel No: + 353 44 934 1638

e-mail: info@qtponline.com, www.qtponline.com

Page of

Wiper Motors

1008

Kit = 4169



Wiper Motor 12 Volt 110°
Small Tapered Shaft
c/w switch
Shaft Length=58mm

3859

Kit = 4195



Wiper Motor 12 Volt 90°
Small Tapered Shaft
c/w Switch
Shaft Length=58mm

3860



Wiper Motor 24 Volt 90°
Small Tapered Shaft
c/w switch
Shaft Length=58mm

4169



Wiper Motor Kit 12 Volt
110° c/w Arm & Blade
Shaft Length=58mm

4195

Motor = 3859



Wiper Motor Kit 12 Volt 90°
c/w Arm & Blade
Shaft Length=58mm

6671



Wiper Motor 300 12V 115°
(Shaft length 78mm)

6645

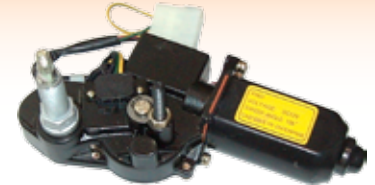

Wiper Motor 390 12V 105°
Large Tapered Shaft
Shaft length 33mm

63240



Wiper Motor Front 54s 42s 43s

1563



Wiper Motor Ford Super Q TW5
TW35 10

59283



Wiper Motor John Deere 6000

51027



Wiper Motor John Deere
SG2 12V 90°

51061

Arm = 2207
Blade = 1619



Wiper Motor 5400 6100 6200
6400 7400 8100
Also Fits 8200 - For Rear
Window

51059

Arm = 2207
Blade = 1619



Wiper Motor 390 398
105° Shaft Length
48mm

63268

Wiper Motor John Deere
SG2 12V 90°



Wiper Motors

41656



Wiper Motor 12 Volt 120; Straight
Single Spin Shaft Length 99mm

51045



Wiper Motor 12 Volt 110; Short Stem
Straight Shaft Length 46mm Arm ref
is 4296

2491



Wiper Motor 12 Volt 80; Small
Tapered Shaft Shaft Length 58mm -
Check Type of Cab

2492



Wiper Motor 12 Volt 110; Small Ta-
pered Shaft Shaft Length 58mm

51006



Wiper Motor David Brown
12V 95; Large Tapered Shaft
- Shaft Length 80mm 1194
1294 1394 1494 1594 1694
1190 1690

51260



Wiper Motor 12 Volt 90;
Small Tapered Shaft Wiper
Motor With Cover & Switch -
Shaft 48mm

2494

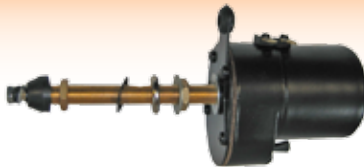

Wiper Motor 12 Volt 105
Degrees Small TapereShaft
Length 94mm

2493



Wiper Motor 12 Volt 85 De-
grees Small Tapered
Shaft Length 94mm

51026

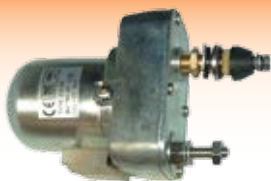

Wiper Motor Case 12V 115;
Small Tapered Shaft
Shaft Length 34mm

51025





Wiper Motor Case 12V 135;
Small Tapered Shaft
Shaft Length 34mm

Wiper Blades

Photo	Part No	Description	Length	
			Inches	mm
	61941	Wiper Blade 4200 4300 6100 - 508mm - 20"	20"	508
	2837	Wiper Blade Ford Q & Super Q Cab 500mm John Deere 50's SG2 Cab Wiper Arm Q Cab 2870		500
	62039	Wiper Blade John Deere 6000 6100 6020 Front	23½"	600
	59803	Wiper Blade John Deere 6000 6010 6020 Rear **Front is 62039** Length: 500mm		

Wiper Arms

Photo	Part No	Description	Length	
			Inches	mm
	2870	Wiper Arm Ford Super Q & Q Cab 431mm - 17"	17"	431
	59802	Wiper Arm John Deere 6000 10 20 30 **Front & Rear**		

Door Hinges

LH

59826

Door Hinge John Deere 00/10's Top LH

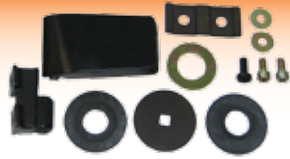

RH

59825

Door Hinge John Deere 00/10's Top RH



59928

Door Hinge John Deere 00/10's Bottom LH



59824

Door Hinge John Deere 00/10's Bottom RH



59630

Door Hinge John Deere 6000 Series Top LH



59629

Door Hinge John Deere 6000 Series Top RH



59632

Door Hinge John Deere 6000 Series Bottom LH



59631

Door Hinge John Deere 6000 Series Bottom RH



4261

Window Handle Ford AP Cab Rear
David Brown & IH Sekura Explorer Cab
1190 1290 1390 1590 1690 John Deere SG2



Rear Windows

59887

Window Hinge John Deere 00/10/20's LH Rear



59886

Window Hinge John Deere 00/10/20's RH Rear



59082

Hinge Side Window John Deere 6100 - 6900 6010 - 6910 6020 - 6920 6130 - 6930 7430 7530 6105M 6115M 6125M 6130M 6140M 6150M 6170M



59832

Window Handle Kit John Deere 50's SG2 Rear



59823



Window Handle Kit John Deere 00 10 20 Rear



Door Parts

<p>59914</p>  <p>Door Lock John Deere - 00 Series Only LH</p>	<p>59452</p>  <p>Seal Door Handle John Deere Inner 61 - 6900</p>	<p>59455</p>  <p>Outer Door Handle John Deere 61 6900 LH & RH</p>	<p>59362</p>  <p>Rubber Door Handle John Deere Outer 6000 7000</p>	
<p>59107</p>  <p>Door Switch John Deere 1550 1750 1850N 1950N 940 1040 1140 1640 1840 2040 RH</p>	<p>59108</p>  <p>Door Lock John Deere 1550 1750 1850N 1950N 940 1040 1140 1640 1840 2040 LH</p>	<p>59081</p>  <p>Knob Door Handle & Lock John Deere 6100 - 6900 RH</p>	<p>59109</p>  <p>Door Handle John Deere 940 1040 1140 1640 1840 2040 1550 1750 1850 1950 RH</p>	<p>59110</p>  <p>Door Handle John Deere 940 1040 1140 1640 1840 2040 1550 1750 1850 1950 LH</p>
<p>59098</p>  <p>Door Latch John Deere 10 20 30 Series LH Inner</p>	<p>59097</p>  <p>Door Handle & Lock Kit John Deere 10 20 30 Series LH</p>	<p>59112</p>  <p>Door Handle John Deere 940 1040 1140 1640 1840 2040 2140 1030 1130 1630 1830 2030 2130 3030 3040 3130 3140 4050 4240 4440 4650 4630</p>		
<p>59111</p>  <p>Door Handle John Deere 1640 2040 3040 3140 4050 4250 4650 4850 LH SG2 Cab</p>	<p>59456</p>  <p>Door Bracket John Deere 6100 - 6900 LH Inner</p>	<p>59119</p>  <p>Door Handle John Deere 6120 6920 7820 30s</p>	<p>59451</p>  <p>Push Pull Inner Door Handle John Deere LH 6000 10 20 30 Series</p>	

Cab Mounts

<p>59454</p>  <p>Bush John Deere Door Glass Small</p>	<p>59329</p>  <p>Cab Mounting Isolator Rubber John Deere 6000 6010 6020 6030</p>	<p>59502</p>  <p>Cab Mounting John Deere 50 Series 60 10 20</p>
---	---	---

Gear Levers

 <p>59357</p> <p>Gear Lever Boot John Deere 40 2630 2640 3120 3050 3350</p>	<p>59266</p>  <p>Gear Lever Knob John Deere 6000 Series 3 Button Power Quad</p>	<p>59403</p>  <p>Range Lever Knob John Deere 6000 Series</p>	<p>59639</p>  <p>Range Lever Knob John Deere 6010 6020</p>
<p>59265</p>  <p>Gear Stick Button Autoquad Plus 20s 30s Gear Stick Complete is 59266</p>			

SG2 Cab Glass

1 4580 Rear Window 13 Hole

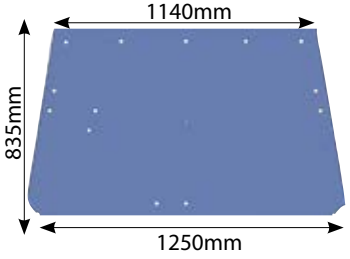
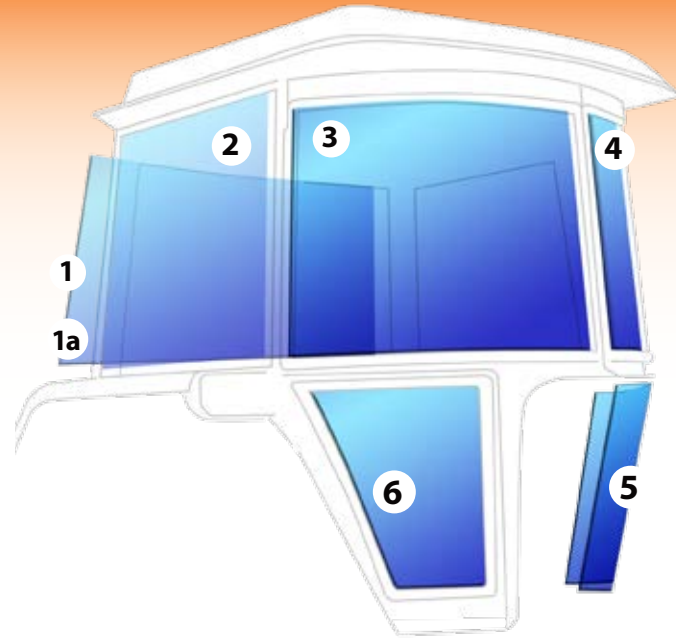
1a 4579 Rear Window 8 Hole

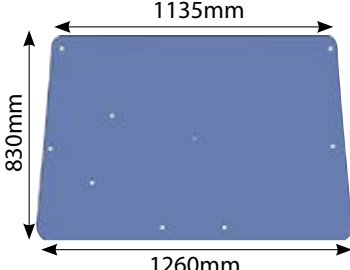

2 58787 Side Window Left Hand + Right Hand

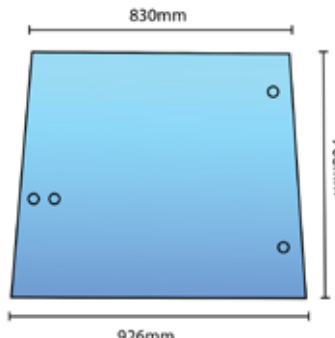

3 52372 Right Hand Front Upper

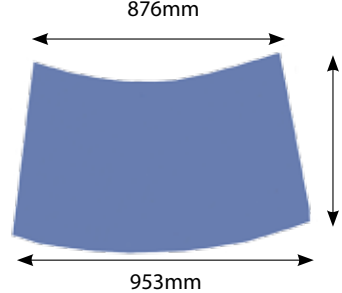

4 4580 Left Hand Door Upper

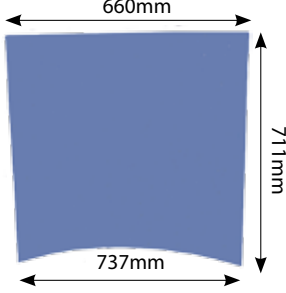

5 52373 Left Hand Door Lower

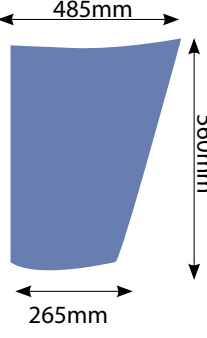

6 52371 Right Hand Front Lower

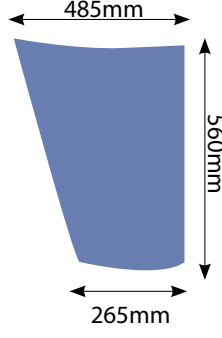

5000 Series Glass

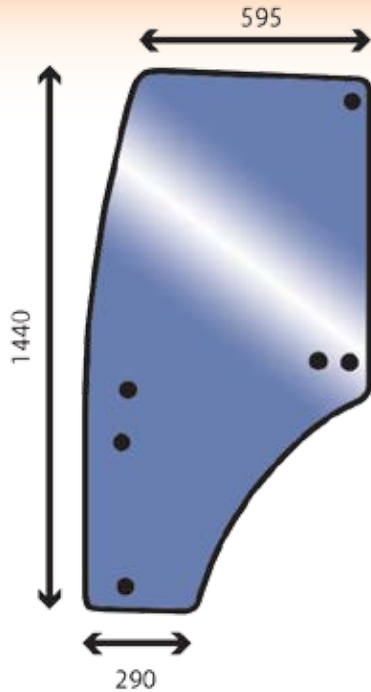

59004
 Glass John Deere 5220 5320 5420 5520
 5620 5820 LH Curved 6 Hole
 OE Ref: R198624

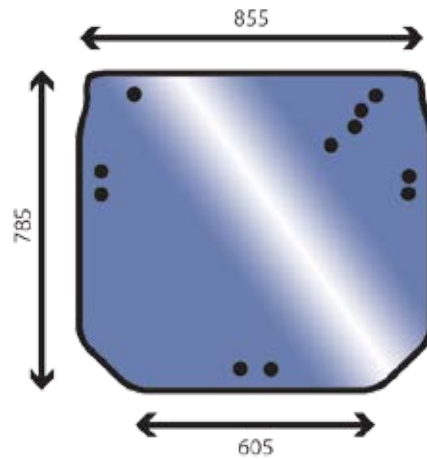

59003
 Glass John Deere 5220 5320 5420 5520
 5620 5820 Rear Upper 11 Holes
 OE Ref: R206835

MCI/CC2 Glass

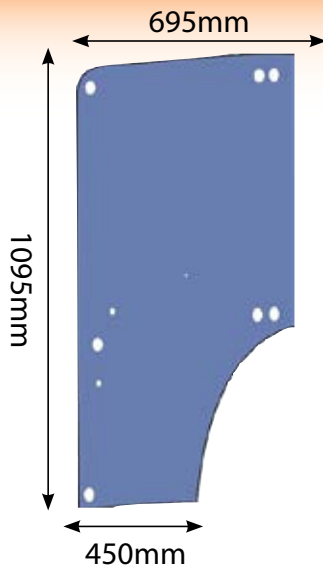

4627
 Glass John Deere MC1 & CC2 Cab Upper Door
 1040 1140 1550 1640 1750
 1850 1950 2040

6000 Series Glass

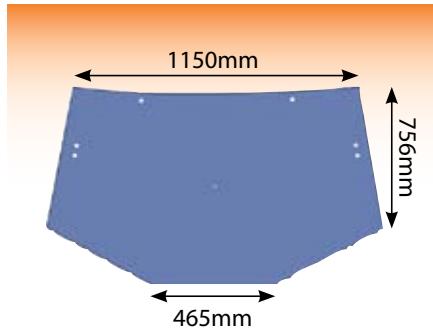
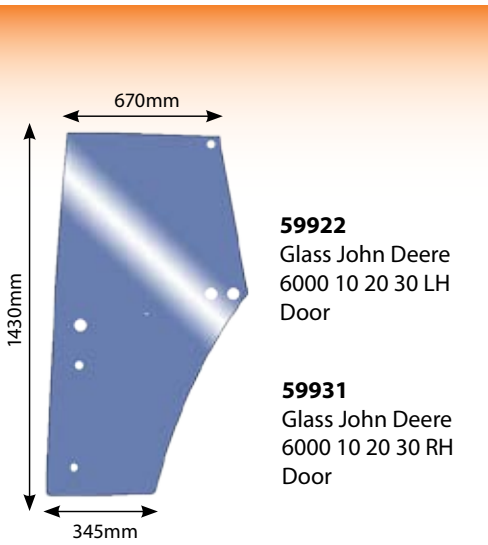

59908
Glass John Deere 6000 10 20 30 Rear
Window Fits all 6000 6010 6020 6030
John Deere's Also 7430 7530 8 Hole

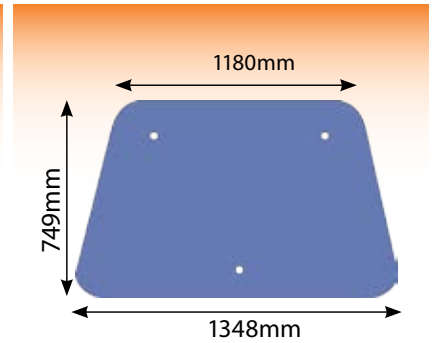

59804
Glass John Deere 10 Windscreen
Front 3 Hole

59072
Glass John Deere 6000 6010 6020 6030 RH

59073
Glass John Deere 6000 6010 6020 6030 LH

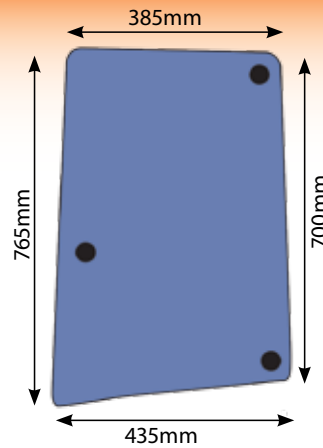

7000 Series Glass

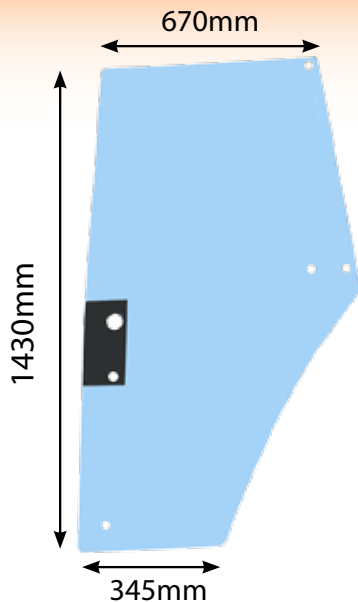

59717
Glass John Deere
7000/10 LH Door
7600 7610 7700 7800
7710 7810 7200 7210
7400 7410 7510

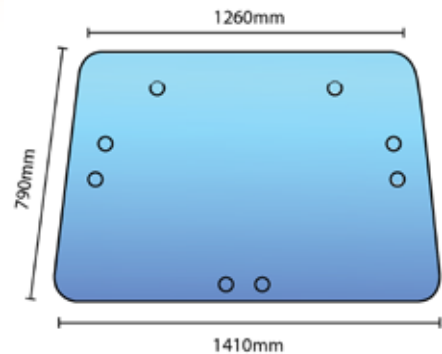

59716
Rear Window Glass John Deere 7000/10
OE Ref: R110990

R Series Glass

58828

Glass John Deere 6105R - 6195R
6210R - 6215R Door RH OE Ref:
L212968

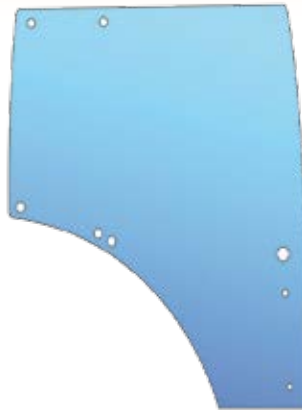

59547

Glass John Deere 6105R - 6195R
6210R - 6215R Door LH
OE Ref: L212967

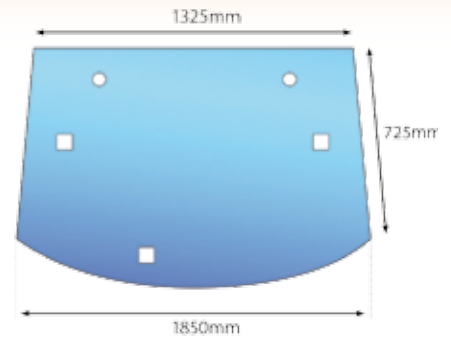

59548

Glass John Deere 6105R -
6195R Rear Window OE Ref:
AL212195

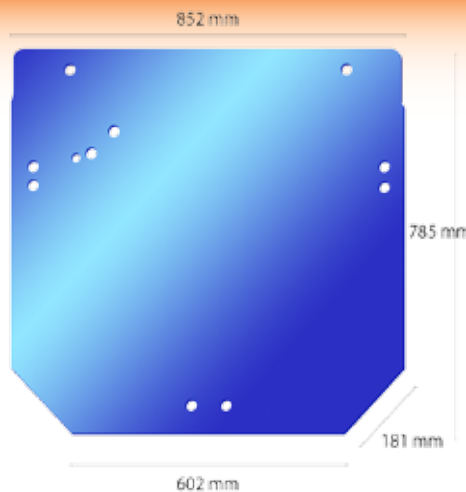

59347

Glass John Deere 5M 5R Rear Window 5080R
5090R 5100R 6090 6110 OE Ref: R261272

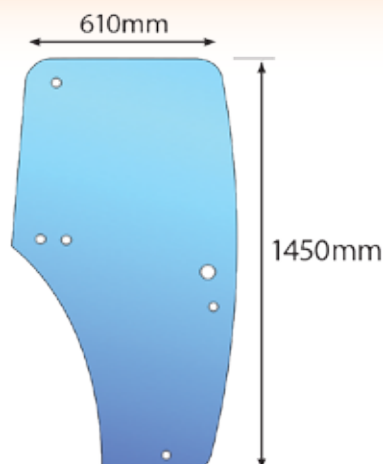

58798

Door Glass John Deere 5020S 5M
5R Door RH OE Ref: R198625

58797

Glass John Deere 5020S 5M 5R
Door LHOE Ref: R198624

Rubbers Strips and Trims

All Rubbers Sold Per Metre

3097



Beaded Strip 500 - Per Mtr (1" or 25mm)

1773



Weather Strip Beaded (22mm)
4.8 mm Glass

1774



Filler Strip for 1773 3097 -
Sold in Mtrs.

1888



S Section Rubber - min sale 25mtr
50 mtr per roll

3984



Vinyl Edge Trim Sold per Metre For
From 0.7 - 2.5mm Glass / Panel

1285



Draught Excluder Rubber - sold by the
metre for 1 to 3 mm 50mtr Per Roll

51553



Filler Strip 20D Bubble Each
Side 10 Mtr Roll Dexta & Major
Bonnet

2548



Weather Strip 300 -
Per Metre

1407



Rubber Section 6mm Metre
for 3mm to 6mm

Rubbers Strips and Trims

51554



Rubber 35 Dash Instrument Panel

51555



Filler Strip c/o Lip - 10 Mtr Roll

1427



Weather Strip Tool

51227



Glass Bonding Kit

51382



Rubber Section -
Per Mtr

59723



Seal - John Deere 20 Series
Front Windscreen

53017

Body Filler IsoPON
P38 Lightweight
250ml



53018

Fibre Glass Repair
Paste IsoPON P40
250ml



53019

Fibre Glass Repair Kit
Fastglas



Electrical Cab Components

6628

Socket 3 Pole - 4 Bolt Fixing
Cobo Also John Deere &
Case



6626

Plug 3 Pin Cobo Also fits
John Deere 00 10 20



59849

Brake Switch John Deere
00/10/20's



59905

Brake Light Switch
John Deere



59074



Pressure Switch John Deere
6100 - 6900 6010 - 6910S
6020 - 6920S 5620 5720
5820 6130 - 6830 5080R
5080RN 5090R 5090RN
5100R 5100N 6105R

59848

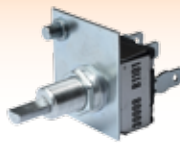

Switch Head Lamp
John Deere 00 10 20 - 3
Position

59692



Neutral Start Switch
John Deere 6000 6010
6020 6030 7010 7020

59054



Temperature Sender
Water John Deere 1020
- 3120 1030 - 3130 1040
- 3640 1350 - 1950 2650
- 3650 6100 - 6900 6010 -
6610 3200 - 3400

58823



Gear Stick Button
John Deere 6020
Series 6030 Series OE
Ref: L158461



59607
Sensor Ground Speed
John Deere 7610 7710
7810 6100 - 6400 6506
6600 6010 6110 6210
63106410 6510 6610
6010SE - 6610SE 6320
6420 6520 OE Ref:
AL204621



59034
Brake Switch John
Deere 2030 3040
3050 3350
OE Ref: AL67715



58911
PTO Mudguard Switch
John Deere 6010 6110
6210 6310 6410 6510
6610 6810 6910 6910S
6020 61206220 6320
6420 6520 6620 6820
6920 6920S 6030
OE Ref: AL208892



59608
Tachometer Sender
John Deere 5200 5300
5400 5500
OE Ref: RE508195



58888
Gauge RPM John
Deere 820 830 920
1020 1030 1120 1130
1630 2020 2030 2120
2130 OE Ref: AL30800

Printed Circuits

2936



Printed Circuit John Deere 50

2931



Printed Circuit John Deere
50 - Fuse Card

3689



Printed Circuit John Deere
40's (Wide)- Fuse

Ignition Switches

4755

Ignition Switch John Deere
Old Type 30 & 40 1030 1130
1630 1830 2030 2130 3030
3130



59811

Ignition Switch
John Deere 00 10
20 30s



58891

Ignition Switch Nut John
Deere 00 10 20 30s ***Switch is
59811*** OE Ref: R115974

59160

Knob for Starter Switch
John Deere 30 40 50 S



59959R

Ignition Switch John Deere
30 40 50 Thermostat
OE Ref: AL62707



3418

Ignition Switch John
Deere



59959

Ignition Switch John
Deere 30 40 50



52098

Ignition Switch Case CX70
CX80 CX90 John Deere 2440
2640 2940 2150 2255
OE Ref:282775A1



59997



Ignition Key John Deere 6000
10 20 Also fits 7000 Series



59997R

Ignition Key John Deere
6000 10 20 Also Fits 7000
Series



59159

Ignition Key John Deere 40
50 Series PAIR ** Switch is
59233R **



59233R

Ignition Switch John Deere 40
50 Series

Flasher Units

1617401

JD
Flasher Unit



59798

Flasher Unit John
Deere 4000 5000
6000



Hazard Switch

58939

Hazard Switch John Deere 6100
6200 6300 6400 6210 6310 6410
6510 6610 OE Ref: AL32062



Relay Units



59762

Relay John Deere
6000 Head Lamp
Micro



59326

Power Cut Off
Relay John
Deere 6020
6030 Standard &
Premium



4556

Relay 12v
Normally
Open 40A

Starters

2 Bolt



59123
Starter John Deere 30s
Premium R Series M Series
6920 2 Bolt LH Fit **OE Ref:**
RE526375



59528
Starter John Deere 6000
6010 4 Cyl 2 Bolt 3120 3130
2040 2140 3040 3140 3640
2 Bolt 2650 2850 3050 3350
3650 **12V & 3.0Kw**



59885
Starter John Deere 2 Bolt
3KW RH FIT 6100 - 6400
6110 - 6410 6120 - 6420
2650 - 3650 & 2140 -
3640 & 3130



59620
 **Letrika**
Starter John Deere
2 Bolt Iskra 3.4kw **
59528 is Replacement
Gear Reduction Type**
** 59885 is Direct Drive
Replacement Type **

3 Bolt



59793
Starter John Deere Renault - 3 Bolt
*10 Teeth
Renault Ares 610 620 630 640 6600-
6900 6506



59621
Starter John Deere 3 Bolt Iskra 4.2
Kw6510 to 6910,6820,6920



59718
Starter John Deere 20 Series 6
Cylinder 6510 6610 6810 6910 6520
6620 6820 6920 Also fits 6506 6600
6800 6900 *11 Teeth*

Gator

59777



Starter John Deere Gator -
Diesel Engine

59212



Starter Motor John Deere
8100 6200 8400 7610 7710
7810 7720 7820 7920 8110
8210 8410 8120 8220 8420
8520

59935



Relay Starter 4 Pin John
Deere 6000 6010

Alternators

59779



Alternator John Deere 6000
12v 85**Amp** 2650-3650
3040-3140 & 6100 - 6900
Case MX Series

59780



Alternator John Deere 12V
90**amp** 62-63-6410 / 62-63-
6420 6230

59778



Alternator John Deere 6010
Series 120 Amp 6010-6910S
& 6010SE-6610SE 6820 6920
6930

58684



Pulley John Deere 20
Alternator with Over
Run Clutch

59693



Alternator Regulator John
Deere 10 Series for bosch
alternator



53696
Regulator Iskra
Oe Ref: 11125202

59767



Alternator Regulator
John Deere 32mm

59766



Alternator Regulator
John Deere - 28mm

59178

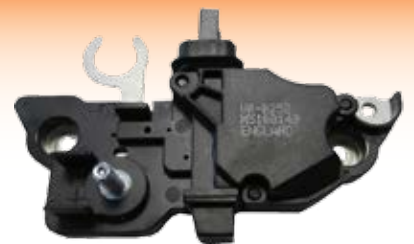

Alternator Regulator John
Deere 10s 20s 30s ** Suits
59778 120Amp + 59780
90Amp**

Electrical Cab Components

Fan Cab Blowers

58690



Fan Cab Blower John
Deere 40 50 10 SG2 Cab 11
Series Combine SG2 Cab

59929



Fan Blower Resistor John
Deere The Blower Fan to
suit is 59637

59637



Resistor 59929

Fan Cab Blower John Deere 6000 7000 6000 6010
6020 6030 7600 7700 7800 5200 5300 5400 5500
7610 7710 7810

58912

Electrical Connector CAN Bus Terminator
- Electronic Control Unit John Deere 6020
6120 6220 6420 6620 6820 6920 6920S
6230 6330 6430 6530 6630 6830 6930 7430
7530 OE Ref: [RE207311](#)



Solenoids

59711



Solenoid 4WD / Diff for John
Deere 6000 10 20

59712



Solenoid for PTO John Deere
10/20 Series

58666



Solenoid Coil Forward John
Deere 20 Series

58665



Solenoid PTO John Deere 20
Series

58667



Solenoid Coil Reverse
John Deere 20 Series

58971



Coil Solenoid Valve John Deere 6010 6110 6210
6310 6410 6510 6610 6810 6910 6820 6920 OE
Ref: [AL118621](#)

Electrical Cab Components

PTO Switch

59939

PTO Switch John Deere
6000/61/62/63's

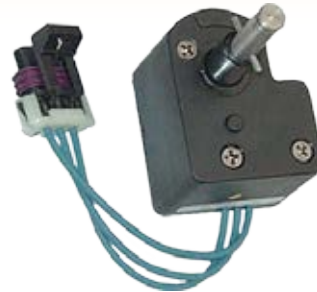

Levers

59953



Forward/Reverse Lever John Deere 20's After S For 20 Series
After Serial number 398797

59806



Forward/Reverse Lever John Deere 10/20 Series Up to Serial
number 398656

59930



John Deere Back End Sys-
tem Pressure Switch

59410



Oil Pressure Switch John Deere
6000 6010 Powerquad Oil Pressure
Enable Switch

59850



Pressure Switch John Deere 00 10 20 Oil
Filter Warning Light

Electrical Cab Components

6000/6010 Series

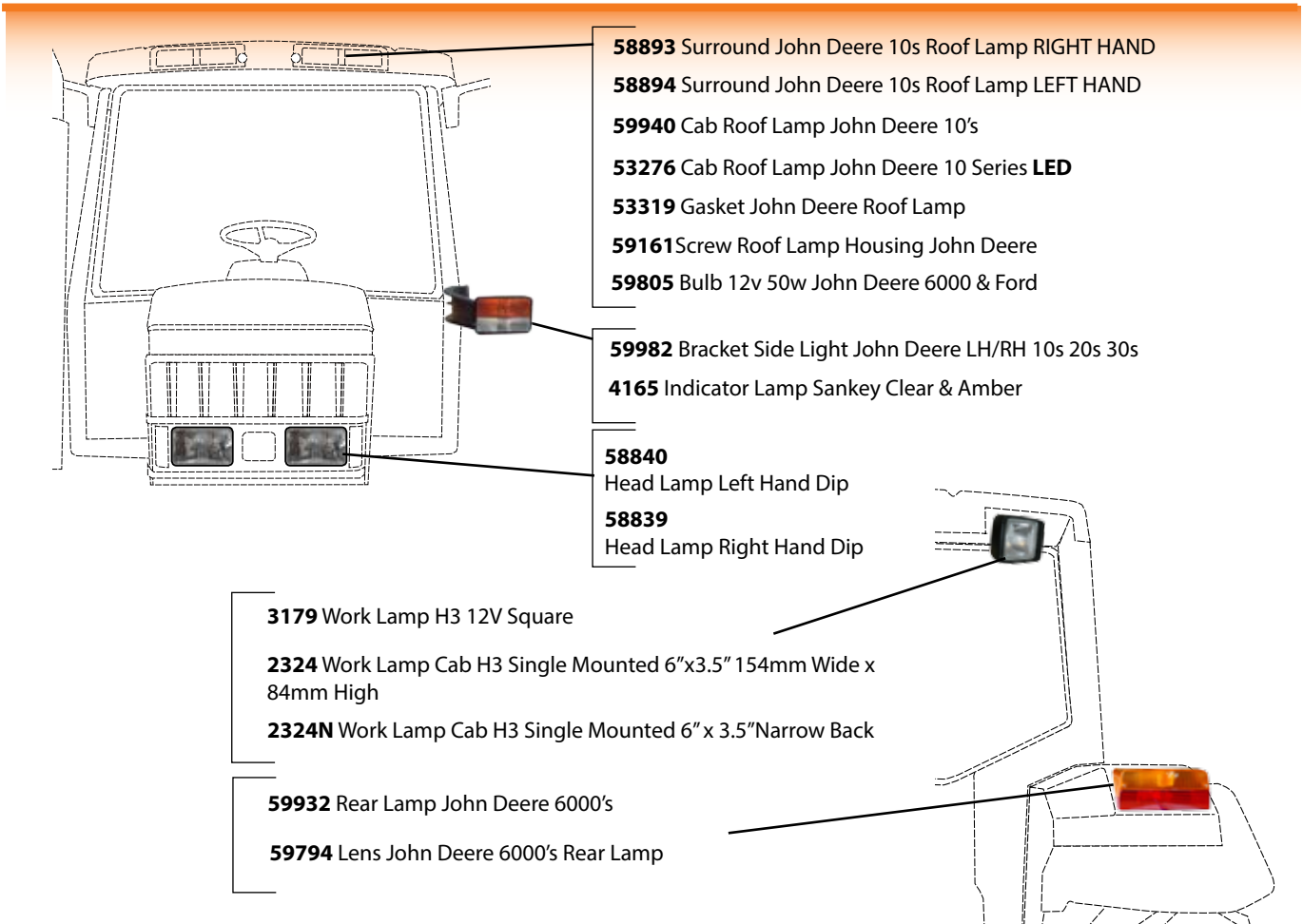

58893 Surround John Deere 10s Roof Lamp RIGHT HAND
58894 Surround John Deere 10s Roof Lamp LEFT HAND
59940 Cab Roof Lamp John Deere 10's
53276 Cab Roof Lamp John Deere 10 Series **LED**
53319 Gasket John Deere Roof Lamp
59161 Screw Roof Lamp Housing John Deere
59805 Bulb 12v 50w John Deere 6000 & Ford

59982 Bracket Side Light John Deere LH/RH 10s 20s 30s
4165 Indicator Lamp Sankey Clear & Amber

58840 Head Lamp Left Hand Dip
58839 Head Lamp Right Hand Dip

3179 Work Lamp H3 12V Square
2324 Work Lamp Cab H3 Single Mounted 6"x3.5" 154mm Wide x 84mm High
2324N Work Lamp Cab H3 Single Mounted 6" x 3.5" Narrow Back

59932 Rear Lamp John Deere 6000's
59794 Lens John Deere 6000's Rear Lamp

6020/6030 Series

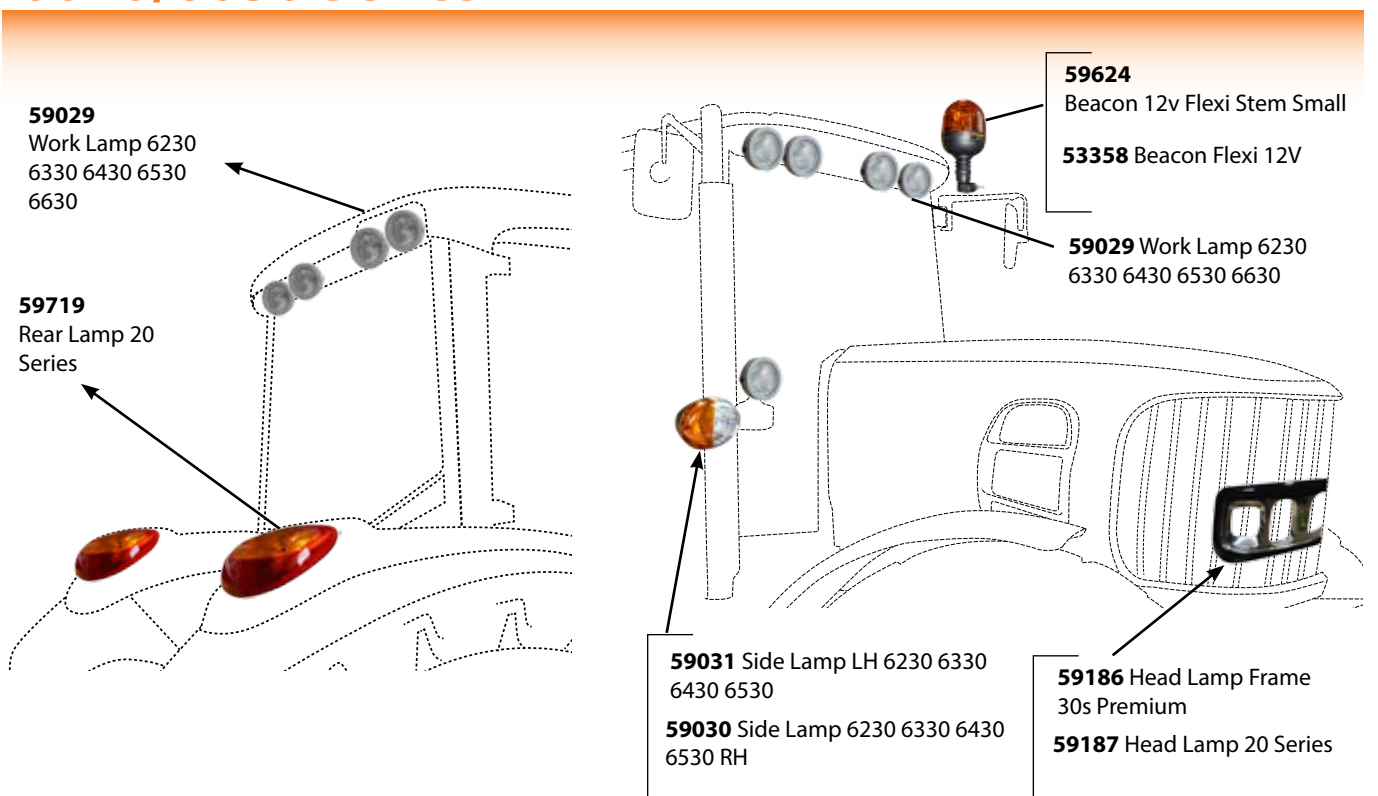

59029 Work Lamp 6230 6330 6430 6530 6630

59719 Rear Lamp 20 Series

59624 Beacon 12v Flexi Stem Small
53358 Beacon Flexi 12V

59029 Work Lamp 6230 6330 6430 6530 6630

59031 Side Lamp LH 6230 6330 6430 6530
59030 Side Lamp 6230 6330 6430 6530 RH

59186 Head Lamp Frame 30s Premium
59187 Head Lamp 20 Series

Electrical Cab Components

Roof Lamps



58893
Surround John Deere 10s Roof Lamp
RIGHT HAND OE Ref: L102378

58894
Surround John Deere 10s Roof Lamp
LEFT HAND OE Ref: L101854



59940
Cab Roof Lamp John Deere 10's
OE Ref: R161288



53276
Cab Roof Lamp John Deere 10 Series
LED OE Ref: RE306510

53319
Gasket John Deere Roof Lamp



59161
Screw Roof Lamp Housing John Deere



59805
Bulb 12v 50w
JD 6000

Headlamps

58840
Head Lamp
6000 6010
Left Hand Dip
OE Ref: AL75341



IRE/UK Version



58839
Head Lamp 6000
6010
Right Hand Dip
OE Ref: AL75338



European Version



59841
Head Lamp Guide John Deere 00
10 20



4478
Head Lamp John Deere **LH** Complete
1040 1640 1840 1850
1950 2030 2040 2130
2140 2450 2650 2850
3030 3040 3050 3130
3140 3350



4422
Head Lamp John Deere **RH** Complete
1040 1640 1840
1850 1950 2030
2040 2130 2140
2450 2650 2850
3030 3040 3050
3130 3140 3350

58843
Head Lamp Assembly
John Deere 2130 2140 Left Hand &
Right Hand c/o Bulb and Rubber
OE Ref: DE17426



59688
Head Lamp John Deere 1830
- 2130 LH
3120 - 3130 - 3030 - 2120



59689
Head Lamp John Deere 1830 -
2130 RH
3120 - 3130 - 3030 - 2120



59187
Head Lamp
John Deere 20
Series



59186
Head Lamp Frame
30s Premium

Electrical Cab Components

Roof Lamps

51400

Work Lamp John Deere
Round H3 12V



2356

Work Lamp Small Rubber
Body 55 Watt bulb 125mm
Diameter 76mm Deep



4250

Work Lamp Side
Mounted RH



59029

Work Lamp John Deere
6230 6330 6430 6530
6630 6830 6930 7430
7530



4249

Work Lamp Side
Mounted LH



51389

Work Lamp John Deere/
Case IHC



3179

Work Lamp H3
12V Square



2324

Work Lamp Cab H3
Single Mounted
6"x3.5"



2324N

Work Lamp Cab H3 Single
Mounted 6" x 3.5" Narrow
Back ** 2324 has Deep Back
** OE Ref:



Electrical Cab Components

Rear Lamps



3645
Lamp Housing To Suit 3646 & 3647 LH & RH
John Deere
50 Series
1350, 1550, 1750, 1950, 2250, 2450,
2650, 2850, 3050, 3350, 3650
40 Series
840, 940, 1040, 1140, 1640, 1840,
2040, 2040 S, 2140, 3040, 3140, 3640



3646
Rear Lamp LH (Hella) 158mm Long
64mm High 51mm Deep

Lens 3648



3647
Rear Lamp Right Hand
Lens 3649

59932



Rear Lamp John Deere 6000's

59794



Lens John Deere
6000's Rear Lamp

59719

Rear Lamp John Deere 20
Series



680090

Rear Lamp Fendt PAIR
200V-205P JD MD925-1188
H/H4/ 820-4020/840 -4240
89m 89mm High OE Ref:
[3223263R91+3223264R9](#)



Indicator Lamps



4165
Indicator Lamp Sankey
Clear & Amber
120mm Long 80mm
High 55mm Deep
Lens to suit 2529



59982

Bracket Side Light John Deere LH/RH

2089

Front Indicator Parking
Lamp 200s 300s Also fits
John Deere 40 50 SG2



59799

Indicator Lamp John
Deere 3130 - Less
Bulbs



Side Lamps



59031



Side Lamp John Deere LH 6230 6330 6430
6530 6630 6830 6930 7430 7530 6000R 6000M
7000R 8000R

59030

Side Lamp John Deere RH 6230 6330 6430
6530 6630 6830 6930 7430 7530 6000R
6000M

Beacons

<p>51320</p>  <p>Beacon 12V Magnetic c/w Bulb Lucas Type</p>	<p>51332</p>  <p>Beacon 12-80v Mini Xenon</p>	<p>59624</p>  <p>Beacon John Deere 12v Flexi Stem Small</p>	<p>51321</p>  <p>Beacon 12v Flexi Stem Lucas Type</p>	<p>53357</p>  <p>Beacon LED Flexi 12/24V</p>	<p>53358</p>  <p>** USE 53855 WHEN STOCK GONE **</p>
--	---	---	---	--	--

<p>43190K Beacon Work Lamp Bracket Kit Left Side</p> <p>Kit includes:</p> <ul style="list-style-type: none"> • Beacon Bracket Assembly • Work Lamp 8 LED 24W Flood 1920 Lumen • Flexi Beacon  <p>43501K- Right Hand Kit</p>	<p>53857 Beacon Kit</p> <p>Includes: Beacon, Bracket, Wiring, Fuse & Switch</p> 	<p>43592 Beacon Kit T6.120 - T6.175 T6010 - T6090 T7.170 OE Ref: 710762034</p> <p>Includes: Beacon, Cable Connections, Bolt Fixing Set, Beacon Pole, Brackets</p> 
---	---	--

Brackets

<p>51388 Beacon Bracket Spring Loaded</p> 	<p>51388B Bracket Angled for 51388 Beacon Bracket 42 43 61 62 81 82</p> 	<p>43190 Beacon Bracket Assembly Ford 5640 6640 7740 7840 8240 8340 LH</p> 	<p>43501 Beacon Bracket Assembly Ford 5640 6640 7740 7840 8240 8340 RH</p> 
<p>3686 Beacon Bracket</p> 	<p>51034 Beacon Bracket Adjustable</p> 	<p>3680 Beacon Plug</p> 	<p>51417 Beacon Bracket John Deere</p> 
<p>51422 Beacon Bracket</p> 	<p>51387 Beacon Bracket</p> 	<p>3687 Beacon Bracket</p> 	<p>51421 Beacon Bracket Adaptor</p> 

Electrical Cab Components

Isolation Switches

3875E

Cut Off Isolation Switch Amp Heavy Duty
 Max Peak Load 12/24V 2500A for 5
 Seconds Max Continuous Load 12/24V
 250A OE Ref: 1939387



3875

H/D Isolation Switch 24V 2500 amp
 (Complete with chain)



51896



Key For Cut Off
 Isolation Switch 24V
 2500 Amp HD

Suits 3875

2923

Cut Off Isolation Switch -
 Heavy Duty



2303

Lucas cut off switch



Warning Lights

1839



Dash Mounted
 Lamp Warning Amber

3101



Dash Mounted
 Lamp Warning Green

1844



Dash Mounted
 Lamp Warning Blue

1259



Red Warning Lamp
 Dash Mounted

2613



Warning
 12v 13mm Hole

1314



Red Warning Light
 12v (13mm Hole)

2616



Light Warning Green
 12v-13mm Hole

2614



Light Blue Warning 12v
 13mm Hole

4556

Relay 12v Normally Open 40A



Number Plate Lamps

3701



Number Plate Lamp Black Plastic
104mm

3633



Number Plate Lamp Small300s
68mm

4233



Number Plate Lamp Black
(100mm)

4845



Licence Plate Lamp
82mm

4846



Number Plate Lamp
87mm

4844

Licence Plate Lamp
112mm



4234

Number Plate Lamp Chrome
(100mm)

1232



Small Interior Light -
116mm x 50mm

3487



Lamp Interior 200mm X 70mm

Bulbs

59805



Bulb 12v 50w John Deere
6000 & Ford

59056



Bulb Dash Lamp John
Deere

H1

H3

H4

3102

Bulb 12v 55w H1 Halogen

3550

Bulb 24v 70w H1 Halogen



1003

Bulb 12v 55w H3 Plough Light
Suits JD 6020 & 6030 Work Lamp

3678

24V H3 70W Bulb



4324

12V H4 80/100W Bulb Halogen

3909

12V H4 60/55W Bulb Halogen

1111

12V H4 60/55W Bulb Halogen
Side Work Lamp 20 Serie



1413



Bulb 12v 21/5w
Stop & Tail

1412



Bulb 12v 21w
Indicator

1360



Bulb 12v 50/40w Dou-
ble Contact P/F

3586



Bulb 12v 5w Dou-
ble Contact S/F

4499



Bulb 12v 21w
Double Contact

1361 Bulb 12v 5w
Single Contact



3160 Bulb 24v 5w
Double Contact S.F

3196

Bulb 12v 3w Capless



4128
Bulb 12v 1.2w Capless

1316



Bulb 12v 45/40W

1971

Bulb Holder Single Contact



4657

Bulb 12v 10w 269

1359

Bulb 12v 5w Festoon



1347

Bulb 12v 4w

4509

Bulb 12v 2w



1965

Bulb Holder Double Contact

Snap & Seal Rings

59749

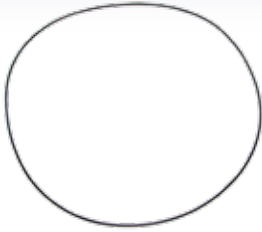

Seal Ring For Clutch John Deere 6000
10 7000

59750



Snap Ring for PTO Clutch John
Deere 50 Also Fits 6000 7000

59748



Snap Ring For Main Clutch John Deere
6000,700

Transmission

58691



Transmission Input Seal Power-
Quad John Deere 6100 - 6900 6010
- 6910 6020 - 6920 6910S 6110SE
- 6610SE 6020SE - 6620SE



58825
Transmission Coupling John
Deere 6000 Series 6010 Series
6020 Series [OE Ref: R119592](#)

59258



Seal John Deere 40 50 Transmission
Hi - Lo Unit

59408

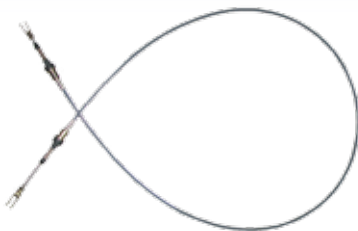

Cable John Deere 6 Cyl SE Forward /
Reverse 6000 6010 6020 6030 Shuttle
Cable

59409



Cable John Deere 4 Cyl SE Forward /
Reverse 6000 6010 6020 6030 6600 6800
6400 Shuttle Cable

59243



Linkage Shuttle Forward
Reverse John Deere 6000
6010 6020

Clutch Cables

59305



Clutch Cable John Deere 6100 6200 6300 6400 6800 6900 6010 6110 6210 6310 6410
6510 6610 6810 6910 6910S SE6510 SE6610

58698



Clutch Cable John Deere 6100 6900 10 Series 1030mm Long

59560

Clutch Cable John Deere 6020 - 6620 6030
- 6630 6105M - 6130M
Length 1025mm Oe Ref: [AL151615](#)



59245
Clevis End John Deere

59591

Clutch Cable John Deere 6120 - 6620
6130 - 6630 6105M 6115M 6125M 6130M
6140M Length 1130mm Without Option
Transmission Housing Oe Ref: [AL151612](#)



59248
Clevis End Safety Pin John Deere

Cable Ends

51956
Cable
End 1/4"
(6mm)



51957
Cable
End 9/32"
(7mm)



51959
Cable End
11/32" (9mm)



51958
Cable End As-
sortment Pack
of 25 1/4" x 3/8",
11/32" x 1/2",
9/32" x 1/2"



40/50 Clutch Parts

1765L

CLUTCH

ASSEMBLY John Deere 40 50 5 Paddle 330mm Split Torque Diaphragm Hub 45x27 Spline Fits John Deere 2650 2850 3050 3350
OE Ref: AL55240



1765



Clutch Assembly John Deere 40 50 5 Paddle No 330mm Split Torque Diaphragm Hub 45x27 Spline Fits John Deere 2650, 2850, 3050, 3350

Clutch Aligning Tool = 59040

59951

Clutch Assembly John Deere 3650 & Disc Only

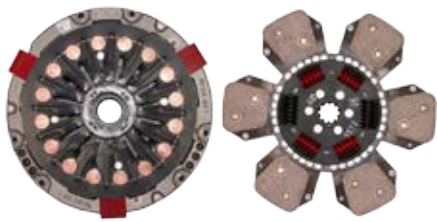

51023

Clutch Disc John Deere 30 40 50 6 Paddle for 1765 - also fits 3650 OE Ref: AL57415



59665

Clutch Disc John Deere 30 40 50 5 Paddle 328mm - 1 1/4" x 10

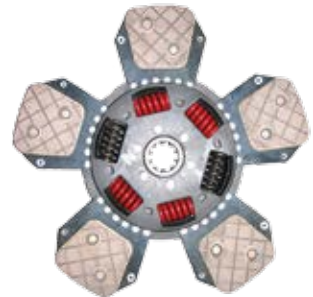

2 Port Hydraulic Release Bearing

Includes LuK Bearings

58990

CLUTCH KIT John Deere 40 50 5 Paddle 330mm Split Torque Diaphragm 45 x 27 Spline Hub
OE Ref: AL361324



Non Hydraulic Release Bearing

Includes LuK Bearings

58989

CLUTCH KIT John Deere 40 50 5 Paddle 330mm Split Torque Diaphragm 45 x 27 Spline Hub
OE Ref: AL120025



3 Port Hydraulic Release Bearing

Includes LuK Bearings

58991

CLUTCH KIT John Deere 40 50 5 Paddle 330mm Split Torque Diaphragm 45 x 27 Spline Hub
OE Ref: AL36134

3985

CLUTCH RELEASE BEARING

John Deere 50's Also Fits Valmet Valtra 6300 6400 8050 OE Ref: AL66088



2 Port

59888

CLUTCH RELEASE BEARING

John Deere 50's 2650 2850 3050 3350 3650
OE Ref: AL39242



3 Port

Clutches

58986

Clutch Kit John Deere 5300 5400 5500 ** PTO Disc Pads 12mm Thick Flywheel Step 24.6mm ** OE Ref: AL120117

REPLACES OMG VERSION



Includes LuK Bearings

58984

Clutch Kit John Deere 5715 5425 5725 5055E 5065E 5076E 5082E 5090E ** Heavy Duty PTO Clutch & 5 Paddle PTO Disc** 280mm OE Ref: RE227648



Includes LuK Bearings

58988

Clutch Kit John Deere 5210 5220 5310 5320 5403 5410 5415 5420 5425 5510 5520 5600 5603 5615 5625 5700 5705 5715 5725 OE Ref: RE227648

Includes LuK Bearings



58987

Clutch Kit John Deere 5310 5310N 5410 5410N 5510 5510N ** PTO Disc Pads 7.5mm Thick Flywheel Step 20mm ** OE Ref: AL120117

Includes LuK Bearings



58899

Clutch Kit John Deere 2000s Zetor Proxima ** Bearings are 5123 & 63042RS ** OE Ref: 938629



58968 Clutch Kit John Deere 1640 2040 2250 2350 2450 2650N 320mm 23 Spline OE Ref: AL120026

Includes LuK Bearings



Clutch Parts

5150

Clutch Assembly John Deere 2000 2100
2200 2300 2400 [OE Ref: 72011060](#)



4686

Clutch Release Bearing John Deere
940 - 1140 1640 - 2040 2140 - 3140 2250 - 2850
3050 - 3350 (Non Hydraulic)



Dot 4 Brake-
Fluid

1904



Flywheel John Deere 2040
3640 1640 2040 2140 3040
3140 3640 2250 2450 2650
2850 3050 3350

[OE Ref: 18678](#)

1696



Ring Gear John Deere 13'
3640 2650 - 3150 3040 3140
<429999 & 2040 >430000
6100 - 6400 6110 - 6410 6120
- 6420

[OE Ref: R114282](#)

59801



Flywheel John Deere
3650



59589

Damper John Deere 6100 -
6900 6110 - 6910 6120 - 6920
Torsional
[OE Ref: AL81266](#)

59516



Clutch Bearing Ware Pad John Deere
2040 2140 3140 3640 3050 3350
2650 2850 3650

3941



Clutch Release Bearing John Deere
2/3130(55mm)

62022RS



Bearing
ID 15mm OD 35mm WD 11mm

53789

CLUTCH ALIGNMENT KIT 32 Dollies &
11 Spigots

Specifications - Fast and accurate alignment of the clutch
and disc

Application - Full clutch alignment kit for tractor
applications, covering all major pilot bearing and disc hub
sizes

Consists of - 32 hub dollies: 14 mm - 45 mm
- 11 spigots: 12 mm, 14 mm, 15 mm, 16 mm, 17 mm, 20 mm,
22 mm, 25 mm, 30 mm,
36 mm, 40 mm



59040

Clutch Aligning Tool John
Deere ** Suits 1765 **





Date:..... No. of Pages:.....

Name of the Rep..... A/C Number:.....

From:..... e-mail.....

Phone No.:..... Fax No.:.....

Please quote for the following parts - Quotation Number :

I wish to confirm the following order on Quotation Number:

Please supply the following parts:

Please photocopy this page

Please do not remove this page

Qty	Part No.	Description	Unit Price
1.			
2.			
3.			
4.			
5.			
6.			
7.			
8.			
9.			
10.			
11.			
12.			
13.			
14.			
15.			
16.			
17.			
18.			
19.			
20.			
21.			
22.			
23.			
24.			

Comments:

Customer Signature: _____ **Rep's Signature:** _____

Tel No: + 353 44 934 1638

e-mail: info@qtponline.com, www.qtponline.com

Page of

Clutch Master Cylinders



59369

Clutch Slave Cylinder John Deere 2040 2140) 3040 3140
(from serial number 430000)



3819R

Repair Kit - Clutch Slave Cylinder John Deere
50 Series 40 Series with SG2 Cab [OE Ref: AL37520](#)



59369R

Clutch Slave Cylinder 2040 2140
[OE Ref: AL34744](#)

3819

Repair Kit John Deere 50 Clutch
Slave Cylinder All 40 Series with
SG2 Cab - Not OPU Cab
Clutch Slave Cyl
Seal Kit SG2 Cab



59558

Clutch Master Cylinder John Deere 40 Series
** Repair Kit is 3818 ** [OE Ref: AL34743](#)

3818

Repair Kit John Deere
50 40 Master Cylinder
Clutch Master Cyl
Seal Kit With
SG2 Cab



59558R

Clutch Master Cylinder John Deere 40 Series **
Repair kit is 3818R ** [OE Ref: AL34743](#)

3818R

Repair Kit John Deere
50 40 Master Cylinder
[OE Ref: AL37517](#)



Clutch Master Cylinders



3823

Clutch Master Cylinder John Deere 40 50 2650 2850 3050 3350
3650 3640 3640S From Serial No 664311



3981R

Seal Kit - Master Cylinder John Deere 50
OE Ref: AL67034



3981

Seal Kit John Deere 50 Master Cylinder



59556

Clutch Master Cylinder John Deere 3640 3640S
2250 2450 2650 2850 3050 3350
OE Ref: AL57619

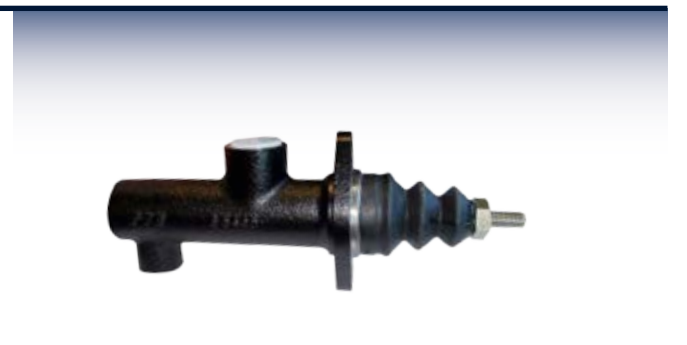

59557

Clutch Master Cylinder John Deere 3640 3640S
OE Ref: AL40974

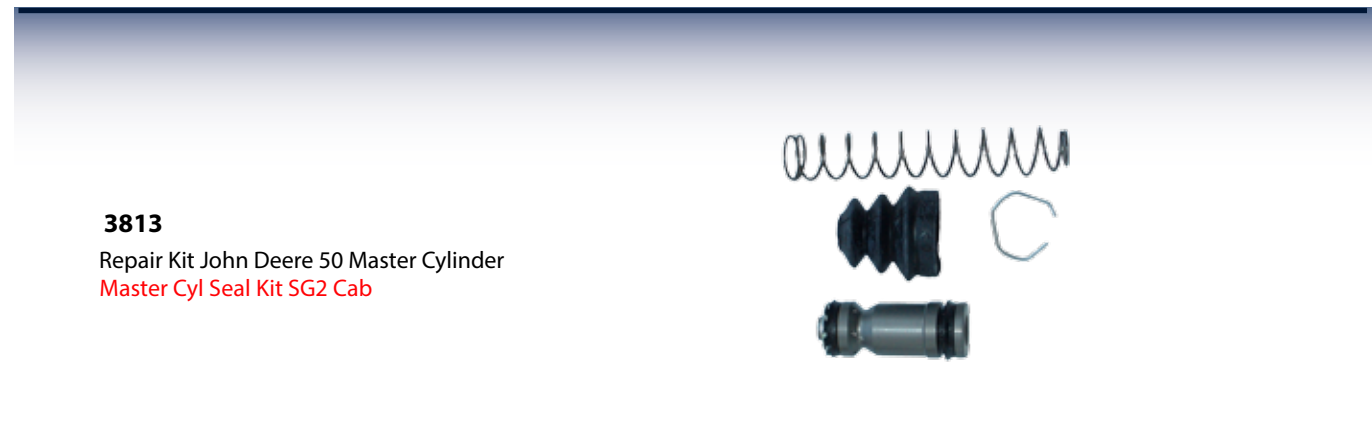







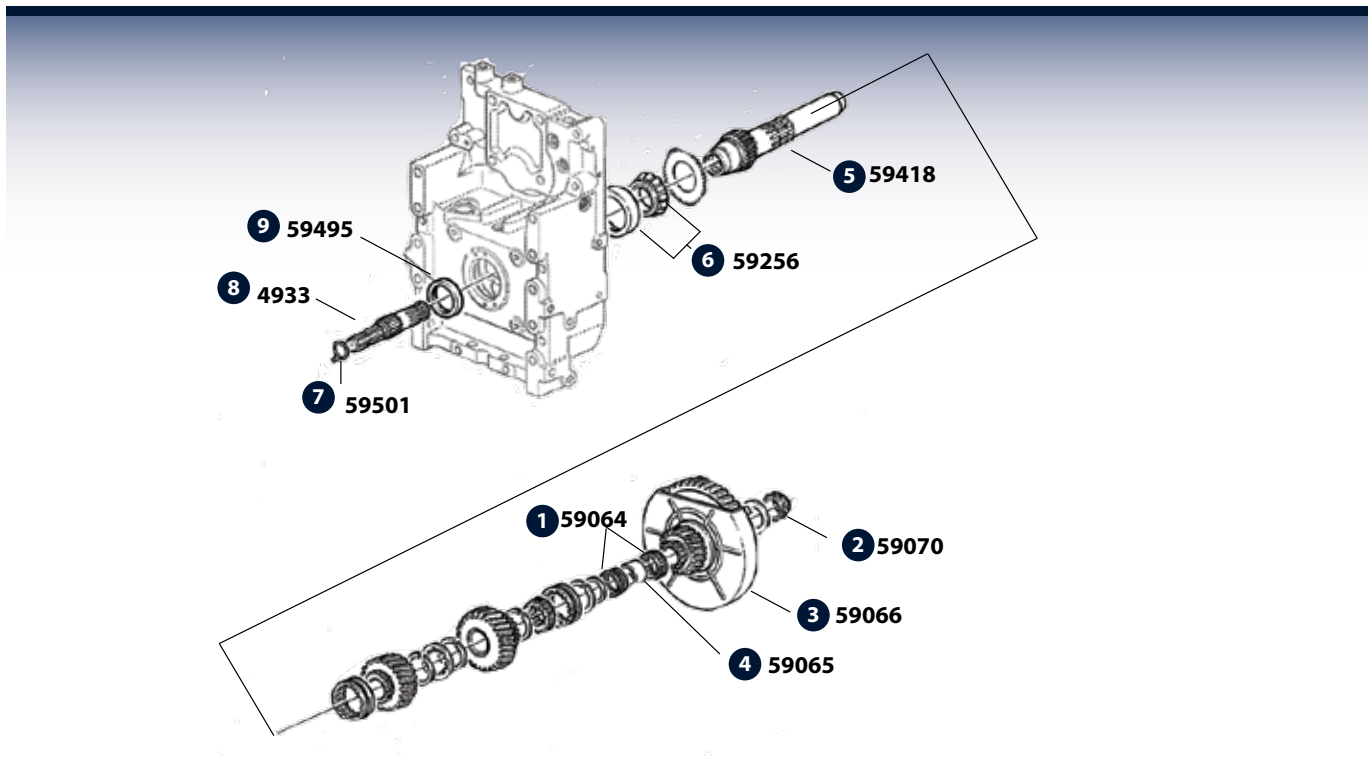

3813

Repair Kit John Deere 50 Master Cylinder
Master Cyl Seal Kit SG2 Cab

Pto Output

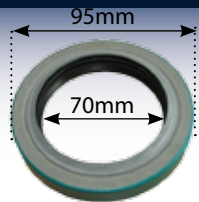
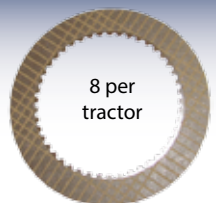

<p>1 59064</p>  <p>Needle Bearing PTO Output Shaft John Deere 6800 6900 6810 6910 OE Ref: AL114548</p>	<p>2 59070</p>  <p>Bearing Cup & Cone PTO Output Drive Shaft John Deere 6800 6900 6810 6910 7810 6170R 6210R 7530 6830 6930</p>	<p>3 59066</p>  <p>Synchro Housing Gear PTO Output Shaft John Deere 6800 6900 6810 6910 6820 6920 OE Ref: RE64467</p>	
<p>4 59065</p>  <p>Spacer PTO Output Shaft John Deere 6800 6900 6810 6910 OE Ref: R95151</p>	<p>5 59418</p>  <p>PTO Output Housing John Deere For 3 Speed PTO Also Suits 6810 6910 6910s 6820 6920 6920s OE Ref: R129768</p>	<p>6 59256</p>  <p>Bearing PTO Output Housing John Deere 68 69 00 10 20</p>	<p>7 59501</p>  <p>PTO Shaft Circlip 50 6000 10 20 30 For 4933 & 60000 & 59937 Shaft OE Ref: R129680</p>
<p>8 4933</p>  <p>PTO Shaft John Deere 6100 - 6900 6010 - 6910 540 - 1000RPM - 6/21 Spline 235mm Long **Also 7600 7700 7800** Circlip 59501 OE Ref: L110178</p>	<p>9 59495</p>  <p>PTO Shaft Seal John Deere 6800 6900 10 20 30 Also fits 7000 Series Smaller Version is 59494 OE Ref: RE38725</p>	<p>59364</p>  <p>Disc PTO Pack John Deere 40 and 50 Series 8 Discs Per Pack/Tractor</p>	

PTO Shafts & Shaft Seals

59936



PTO Shaft John Deere 3000 3100 3300 36 540rpm

59418



PTO Output Housing John Deere For 3 Speed PTO
Also Suits 6810 6910 6910s 6820 6920 6920s

59938



PTO Shaft John Deere 3000 3100 3300 36
540rpm

58972



PTO Shaft John Deere 30 Series 1 3/8" 21
Spline 1 3/8" 6 Spline 235 Long [OE Ref: L173283](#)

2487



Pinion Shaft John Deere
20 30 40 50 55

4933



PTO Shaft John Deere 6100 - 6900 6010 - 6910 540 - 1000RPM
- 6/21 Spline 235mm Long **Also 7600 7700 7800

Circlip = 59501

60000



PTO Shaft John Deere 6020 - 6620 Also suits
6030 - 6630 (Premium & SE) 5620 5720 5820

Circlip = 59501

52370



PTO Output Housing John Deere
6810 6910 6800 6900 6810 6910
6820 6920 2 Speed 7610 7710 7810

59937



PTO Shaft John Deere 3000
3100 33 36 1000rpm

Circlip = 59501

59050



PTO Shaft John Deere 3 Cyl
20 30 35 Series

PTO Shaft Seals

59494

PTO Shaft Seal John Deere 6100
6600 10 20 30
Bigger Version is 59495

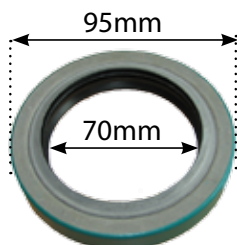

59495

PTO Shaft Seal John Deere 6800 6900
10 20 30 Also fits 7000 Series Smaller
Version is 59494

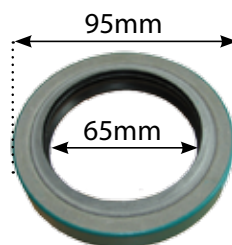

58914

Seal PTO Shaft John Deere 6020 6120
6220 6320 6420 6510 6620 6130 6230
6330 6430 6530 6630
[OE Ref: AL150750](#)



Cover Gaskets

Planetary Brake

- | | | |
|-----|------------------|---|
| 1. | 59350 x 1 | Planetary Brake Disc John Deere Powerquad c/w Inner Spline |
| 2. | 59742 x 1 | Piston for Planetary Brake 6000 10 20 7000 |
| 3. | 59728 x 2 | Clutch Plate John Deere 6000 Planetary Brake |
| 4. | 59727 x 2 | Brake Disc Planetary Brake John Deere 6000 6900 6600 6400 6100 6200 6300 6800 |
| 5. | 59726 x 1 | Disc for Planetary Brake John Deere 6000 |
| 6. | 59739 x 2 | Piston for Planetary Brake 6000 10 20 7000 |
| 7. | 59736 x 1 | Powerquad Bolt for Planetary Brake 6010 7000 |
| 8. | 59737 x 1 | Powerquad Bolt John Deere 6010 7000 into Clutch Housing |
| 9. | 59735 x 2 | Washer for Powerquad bolts |
| 10. | 59740 x 3 | Disc for Planetary Brake JD 6000 10 20 7000 |

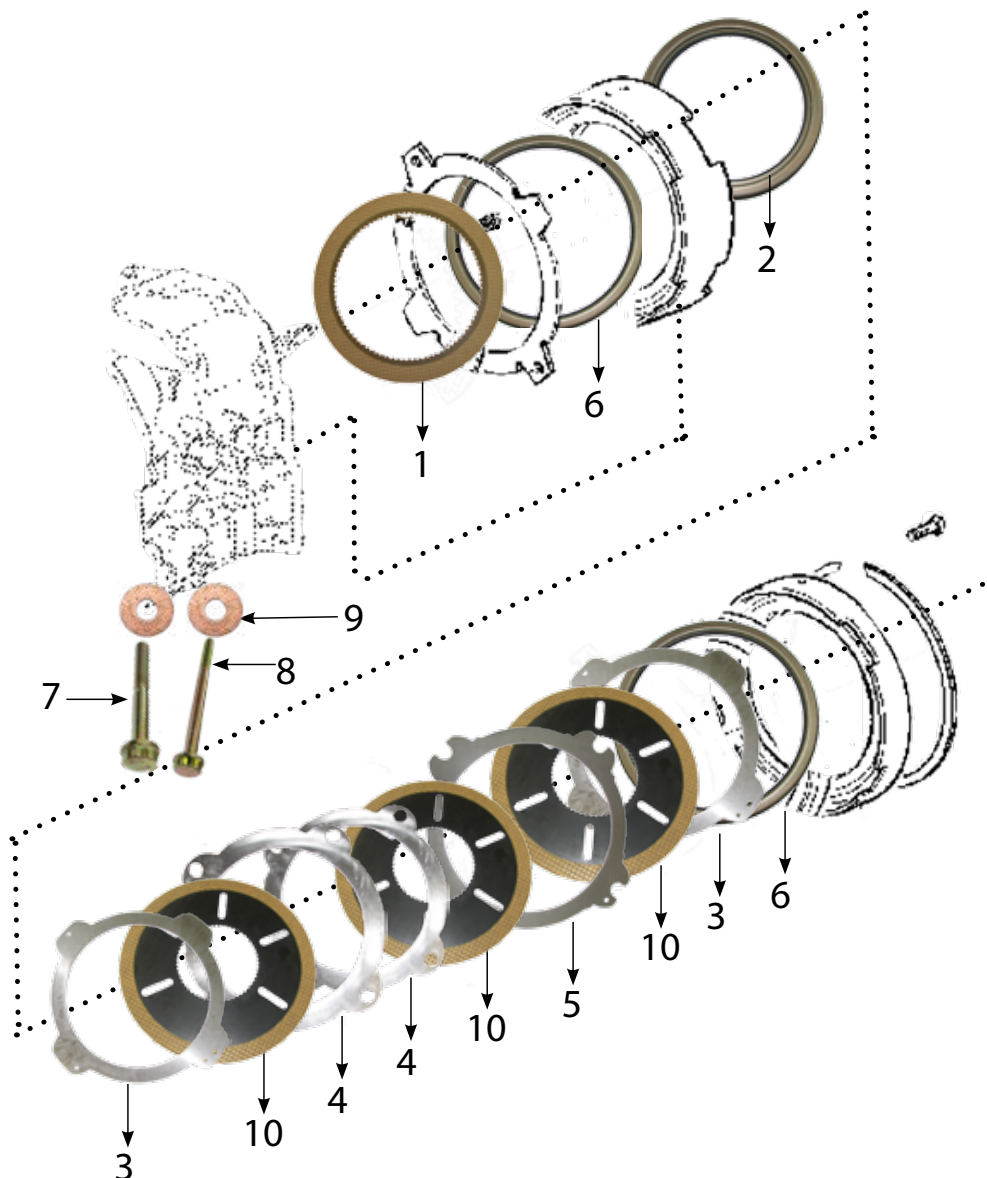

Traction Clutch

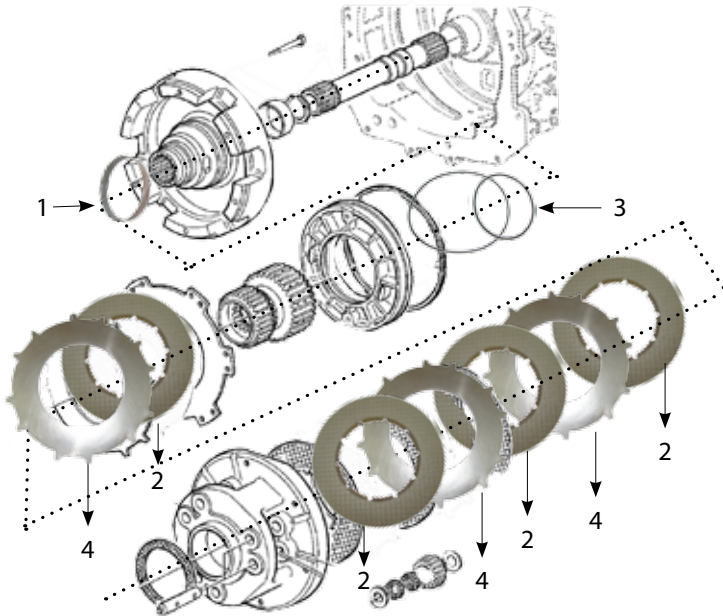

- | | | |
|----|------------------|--|
| 1. | 59342 x 1 | Bushing John Deere Traction Clutch |
| 2. | 59747 x 4 | Brake Disc Traction Clutch J.Deere 6000 Also fits 10 20 7000 |
| 3. | 59745 x 1 | Seal Back of Traction clutch 68-6910 6520-6920 |
| 4. | 59746 x 3 | Clutch Plate Traction Clutch J.Deere 6000 Also fits 6010 6020 7000 |

Reverse Brake Housing

- | | | |
|----|------------------|--|
| 1. | 59744 x 4 | Disc Reverse Brake Housing JD 7000 Also fits John Deere 6000 10 20 |
| 2. | 59743 x 3 | Clutch Plate - Brake Housing 6000 10 20 7000 |
| 3. | 59738 x 1 | Reverse Brake Housing Gasket 6000 10 7000 |
| 4. | 59340 x 1 | Piston Ring Reverse Brake Housing |
| 5. | 59341 x 1 | Disc Reverse Brake Housing Fits 00 10 20 30 R Series |

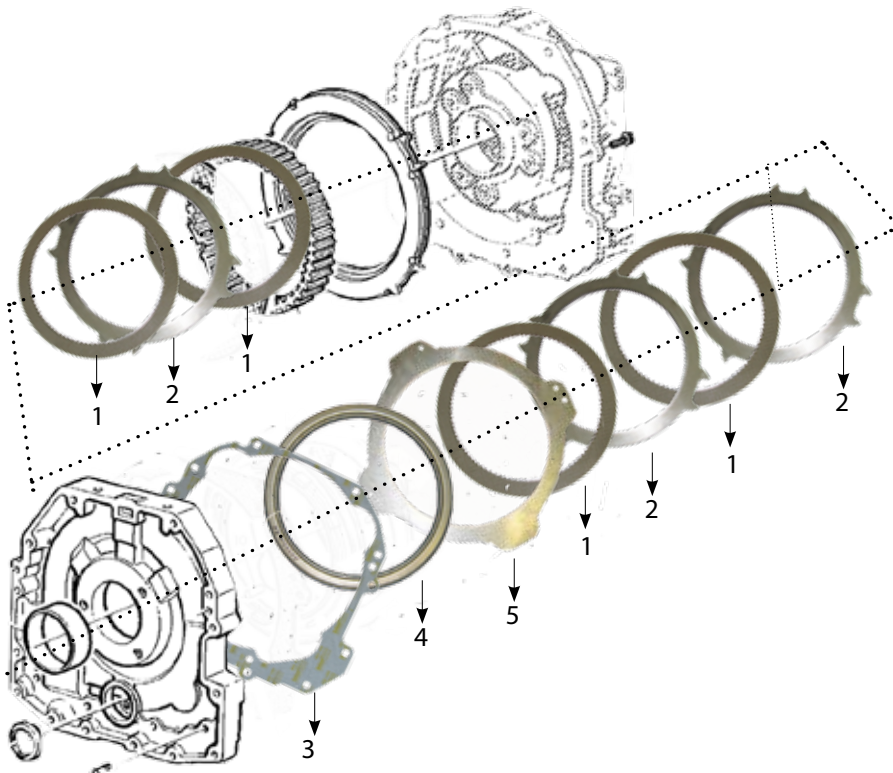



Cover Gaskets



<p>59733</p>  <p>Front Valve Housing Cover Gasket John Deere Fits 6000 10 7000</p>	<p>59734</p>  <p>Transmission Front Cover Gasket 6000 6010 Also fits 7000</p>	<p>59732</p>  <p>Gasket John Deere 6010 6020 Creeper Box</p>	<p>59500</p>  <p>Gasket John Deere 6100 - 6600 & 10 20 Back En 6110 - 6610 / 6120 - 6620</p>	<p>59179</p>  <p>Gasket Range Transmission John Deere 60006600 6610 6620 6630</p>
--	---	--	---	---

Pump Gears

<p>59753</p>  <p>Inner Gear in Powerquad Transmission Pump JD 6800-6920S</p>	<p>59752</p>  <p>Outer Gear in Powerquad Transmission Pump JD 6800-6920S</p>	<p>59756</p>  <p>Inner Gear Powerquad Transmission Pump John D 6100 - 6620</p>	<p>59755</p>  <p>Outer Gear Powerquad Transmission Pump John D 6100-6620</p>
--	--	---	--

<p>59595</p> <p>Gear Set Transmission Oil Pump John Deere 940 1040 1140 1640 1840 2040 2140 3040 3140 OE Ref: AL68435AL68435</p> 	<p>58998</p> <p>Gear Transmission Oil Pump John Deere 940 1040 1140 1640 1840 2040 840 2250 2450 2650 1950 1550 1750 1850 OE Ref: AL119948</p> 
--	--

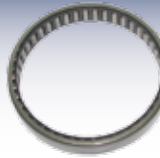
<p>59862</p>  <p>Bolt Transmission Drive Shaft John Deere Fits 00/10/20's 40mm</p>	<p>59861</p>  <p>Bolt Transmission Drive Shaft JD Fits 00/10/20's 20.5mm</p>
--	---

<p>59751</p> <p>Relief Valve for Powerquad Pump John Deere 6000,10,20,7000</p> 	<p>59754</p> <p>Bearing John Deere Powerquad Transmission Pum Pump fits 6000 6010 6020</p> 	<p>59741</p> <p>Clutch Seal John Deere 6000 6010 6020 7000 Direct Drive</p> 
---	---	--

<p>59838</p>  <p>Transmission Hose John Deere 00/10/20</p>	<p>58996</p> <p>Shaft Power Train Pinion John Deere 2030 1830 2240 1020 1120 1030 1130 1630 940 1040 1140 1640 1840 2040 1550 1750 1850 1950 OE Ref: T38049</p> 
--	--

<p>59208</p>  <p>Oil Pump Transmission John Deere 50 55 Splined</p>	<p>59209</p>  <p>Oil Pump Transmission John Deere 20 30 40 50 c/o Small Bearing</p>	<p>59207</p>  <p>Oil Pump Transmission John Deere 40 50 55 Thick Pump with Keyway</p>	<p>59210</p>  <p>Oil Pump Transmission John Deere 20 30 40 50 c/o Big Bearing ** Gear Set is 59206 **</p>	<p>59206</p>  <p>Gear Set for 59210 John Deere Oil Pump John Deere 20 30 40 50</p>
---	---	---	--	--

O Rings

59730



O Ring for Powerquad John Deere 6000

59729



O Ring for Rear Oil Return Pipe 6000

59731



O Ring for Return Oil Pipe From Trans 6000

59168



O Ring John Deere Powershift Transmission Valve 7810 7930 7720 7820 7920 6810 6910 6120 6220 6320 6420 6520 6620 6820 6920 7430

59169



O Ring John Deere Powershift Transmission Valve 5620 5720 5820 5310 5410 5510 6020 6120 6220 6320 6420 6520 6620 6820

59170



O Ring John Deere Transmission Valve 7800 7710 7810 7720 7820 7920 3040 3140 1640 2040 2140 6610 6810 6910 6020 6120 6220

59171



Washer John Deere Powertrain Transmission 1020 2020 2030 2440 2640 2940 2040 2240 3030 3130 1530 1830 2030 2130

59172



O Ring John Deere Transmission Valve 7700 7800 7410 7510 7610 7710 7810 7720 7820 7920 6310 6410 6510 6610 6810 6910 7130 7230 7330

59173



O Ring John Deere Powershift Transmission Valve 7610 7710 7810 7720 7820 7920 6810 6910 6020 6120 6220 6320 6420 6520

59174

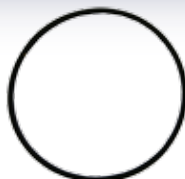

Washer John Deere Rockershaft Piston Cover 4755 4955 4640 4840 4650 4850 4555

59175



O Ring John Deere Transmission Valve 7610 7710 7810 7720 7820 7920 7630 7730 7830 7930

Brake Parts

4 Cylinder Back End Bearing



59571

Bearing John Deere 6010 6020 6100 6110 61206130 6200
6230 6300 6310 6320 6330 6400 64106420 6430 6505 6506
6510 6520 6530 6600 66106630

Inner Half Shaft

OE Ref: AL156503 cone



59572

Bearing John Deere 6010 6020 6100 6110 61206130 6200
6230 6300 6310 6320 6330 6400 64106420 6430 6505 6506
6510 6520 6530 6600 66106630

Outer Half Shaft

OE Ref: AL156506 cone + L154

6800-6900 / 6810-6910

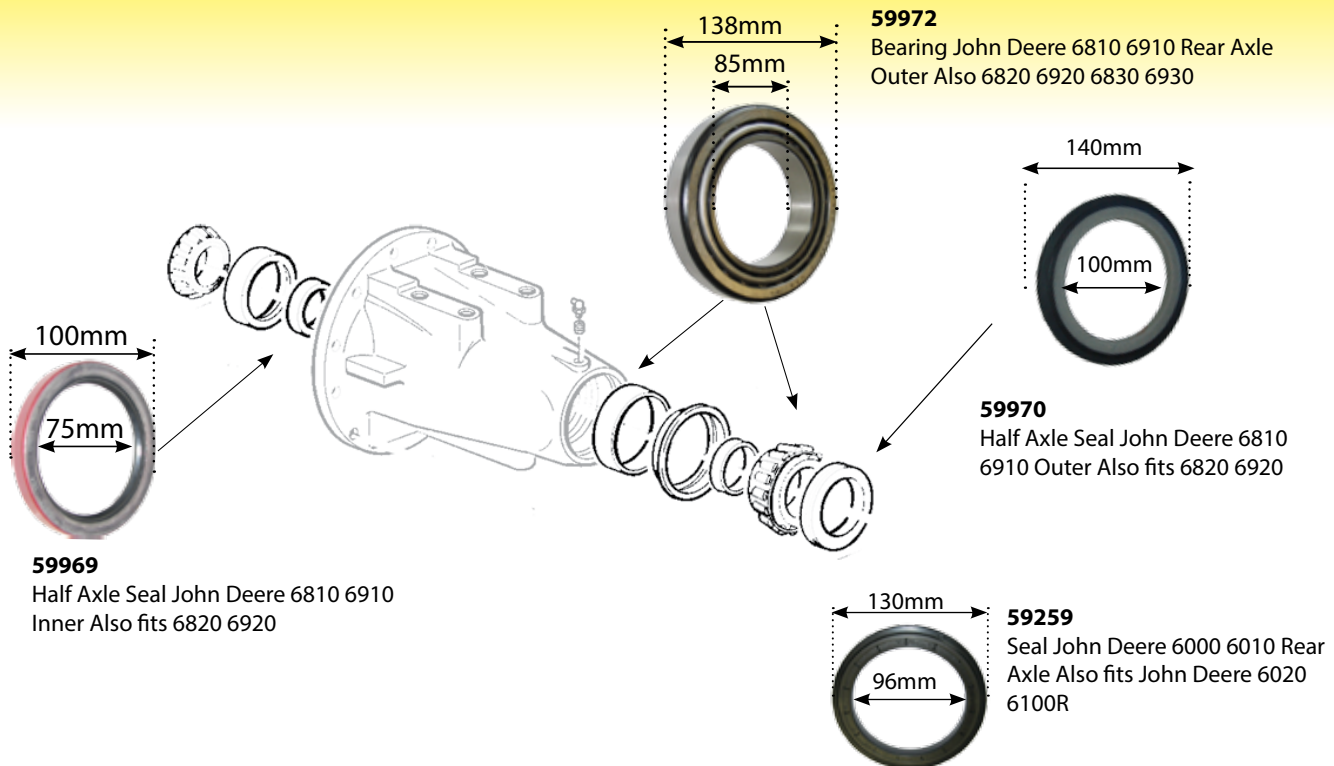

Brake Parts

6820-6920

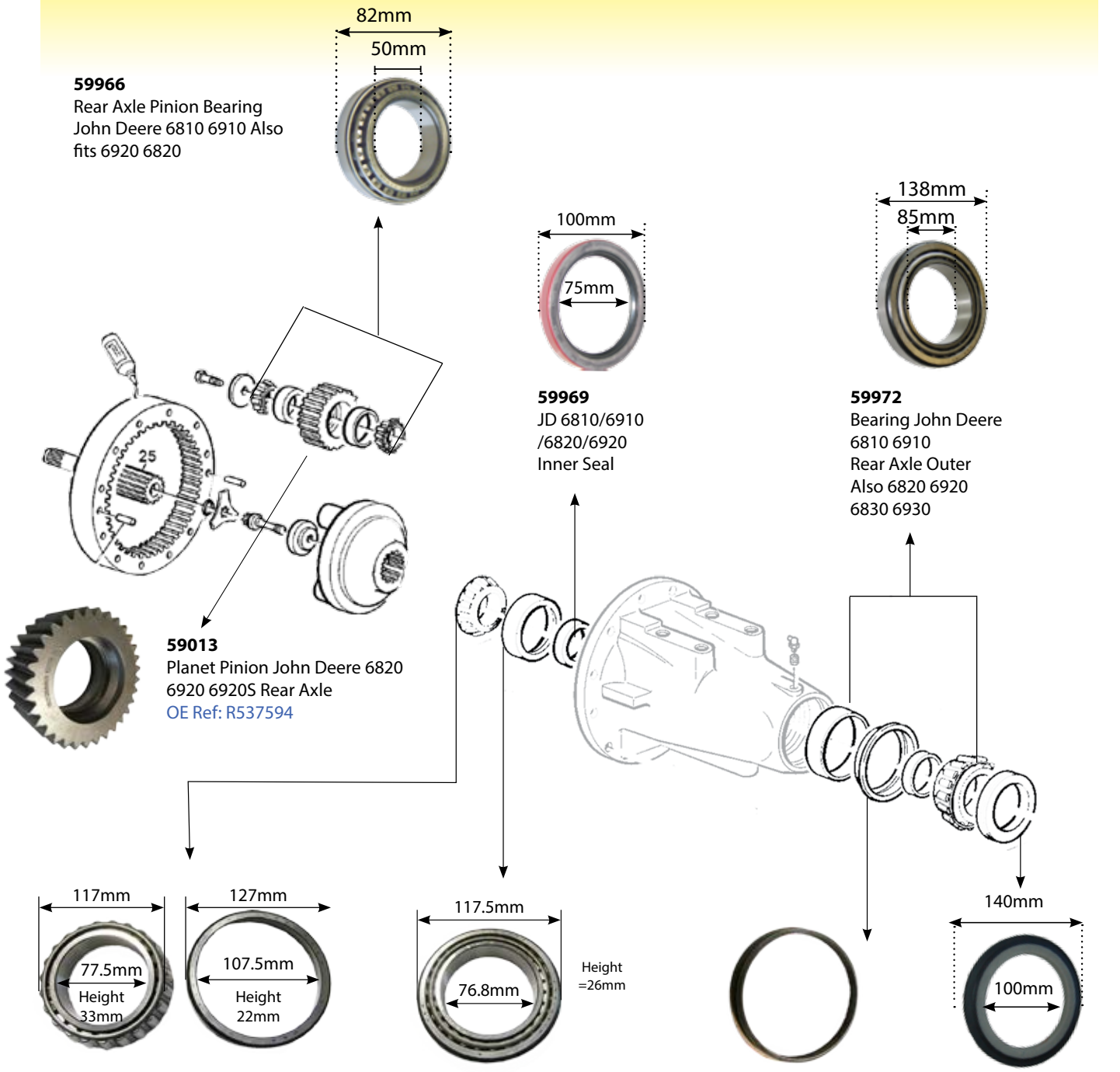

59966
Rear Axle Pinion Bearing
John Deere 6810 6910 Also
fits 6920 6820

59969
JD 6810/6910
/6820/6920
Inner Seal

59972
Bearing John Deere
6810 6910
Rear Axle Outer
Also 6820 6920
6830 6930

59013
Planet Pinion John Deere 6820
6920 6920S Rear Axle
OE Ref: R537594

59012
Bearing Cup & Cone John Deere 6820
6920 6920S Rear Axle
OE Ref: RE300296+RE300295

59417
Bearing John Deere 6820
6920 Rear Axle Inner
OE Ref: RE286515

59015
Wear Ring John Deere
6820 6920 6920S **Rear
Axle**
OE Ref: R57269

59970
Half Axle Seal John Deere
6810 6910 Outer
Also fits 6820 6920

Brake Parts

61/62/63/64/65/66/Series in 00/10 and 20 Series

59180



Pawl Parking Lock Range Transmission John Deere 6000 6600 6010 6610 ** To Serial No 232672 **

58906

Hand Brake Cable John Deere 6506 6600 6010 6110 6210 6310 6410 6510 6610 6020 6220 6320 6420 6520 6620 6010, 6110, 6210, 6310, 6410, 6510, 6610, 602 6220, 6320, 6420, 6520, 6620
OE Ref: AL157792



59117



Bush John Deere 6000 6600 6010 6610 ** Suits 59180 **

59125



Torsion Spring Parking Lock John Deere 6000 6600 10 20 30 ** Pawl is 59180 ** Pawl Bush is 59117 **

59181



Spring Parking Lock Range Transmission John Deere 6000 6600 6010 6610 ** To Serial No 232672 **

59942



Brake Piston John Deere 6100 - 6600 6110 - 6610 & 6120 - 6620 & 6130 - 6630

59943



Brake Ware Plate John Deere 6100 - 6600 6110 - 6610 & 6120 - 6620 & 6130 - 6630

59976



Brake O Ring John Deere 6100 - 6600 Small 6110 - 6610 & 6120 - 6620 & 6130 - 6630 **Large O Ring is 59977**

59975G



Brake Disc John Deere 6100 - 6600 Genuine Also fits 10 20 Series - 14 Splines

59975K

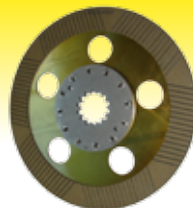

Brake Disc John Deere 6100 - 6600 Kevlar Also fits 10 20 - 5.9mm 14 Splines ** 4.9mm Disc is 59192 **

Lasts up to 40% longer

59977



Brake O Ring John Deere 6100 - 6600 6110 - 6610 & 6120 - 6620 & 6130 - 6630 **Small O Ring is 59976**

59192

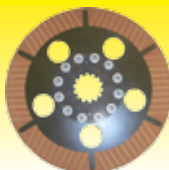

Brake Disc John Deere 6425 6100SE 6210 6420L 7220 6500 6520 4.9mm Thick (Not KEVLAR) ** 5.9mm Disc is 59975K **

59727



Brake Disc for Planetary Brake 6000

59720



Brake Kit John Deere 6100 - 6620 - Both Sides

Brake Parts

68/69/Series in 00/10 and 20 Series

59955



Brake Ware Plate John Deere 6800 - 6900
 6810 - 6910 & 6820 - 6920
 Piston to suit is 59992

59957

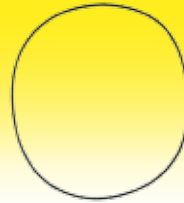

Brake Piston O Ring John Deere 6900 - Large 6800 6900 6810 6910 6820 6920 6830 6930
 Small to suit is 59956

59900



Brake Disc John Deere 6800 - 6920 Brake Disc John Deere 6800 - 6920 15 Splines For Kevlar - 59900K Genuine 59900G

59992

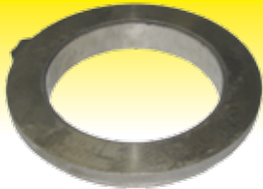

Brake Piston John Deere 6800 - 6900 6810 - 6910 & 6820 - 6920
 Ware plate to suit is 59955

59956

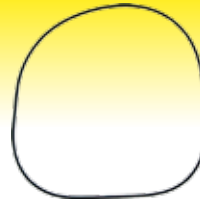

Brake Piston O Ring John Deere 6900 (Small) 6800 6900 6810 6910 6820 6920 6830 6930
 Large to suit is 59957

59900K

DuPont™
KEVLAR®



Brake Disc John Deere 6800 - 6920 Kevlar 15 Splines 7.7mm ** Kits 59538 59721 **

Lasts up to 40% longer

59538

Brake Kit John Deere 6800 - 6920S One Side

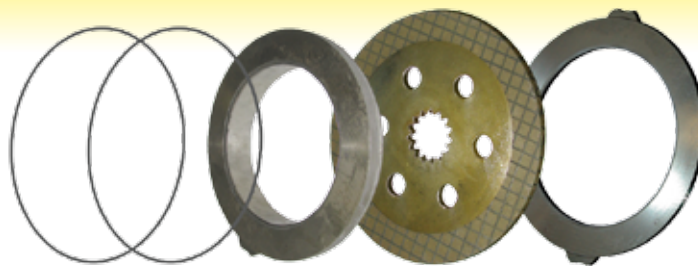

59721

Brake Kit John Deere 6800-6920S - **Both Sides**



Brake Parts

76/78/Series in 00/10 and 20 Series



58834

Brake Disc John Deere 7630 7730 7830 7430 72220
7320 7420 7520 6110R 6120R 6920SE 7600 7700
7800 7200 7400 7210 7410 7510 7610 7710
OE Ref: [RE273492](#)



59709

Brake Disc John Deere 7600 - 7800
7600 - 7810 From S/N 007411 Teeth
have square profile 15 Splines

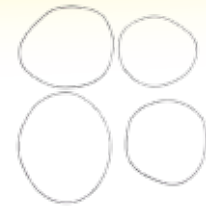

59706

Brake Piston O ring John
Deere 76-7810 Note:
Complete tractor Kit (2
big & 2 small)

Brake Parts 6830/6930

59957

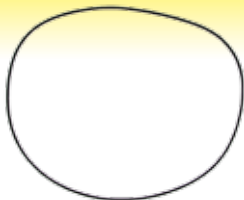

Brake Piston O Ring
JD 6900 (**Large**)
6800 6900 6810 6910
6820 6920 6830 6930

59956

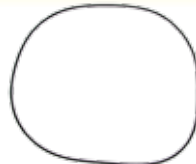

Brake Piston O Ring
John Deere 6900 (**Small**)
6800 6900 6810 6910
6820 6920 6830 6930

59857



Brake Check Valve John
Deere 10/20

59386

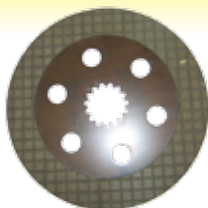

Brake Disc John Deere
6830 - 6930 6800 - 6920 15
Spline

59384



Brake Ware Plate John Deere
6830 - 6930

59385



Brake Piston John Deere
6830 - 6930

59715



Dowel Pin For John Deere
7000/10 Brakes

Brake Parts

30 40 50 Series



3750

Brake Disc John Deere 40 50- 15 Spline
4.95mm From Serial No: 668665 2250
2450 2650 2850 3050 3150 3350 3650
3040 3140 3640



3749

Brake Disc John Deere 30 40 50
Series 10mm 15 Spline Up to Se-
rial No: 668664 2250 2450 2550
2650 2850 3050 3150 3350 3650
1640 2040



59614

Check Valve Brake Valve John
Deere 2020 2440 2040 2240
3120 1020 1120 820 920 2120
1030 1630 2030 2130 3130 940
1040 1140 1640 2040 **OE Ref:**
[AL23836AL23836](#)



59349

Brake Ware Plate John Deere 30 40
50 Series 14mm thick From Serial
719163 & 713945

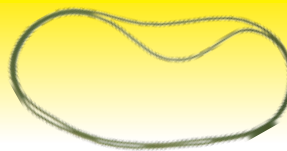

59977

Brake O Ring John Deere 6100 - 6600
6110 - 6610 & 6120 - 6620 & 6130 - 6630
(Large) - 96 cm

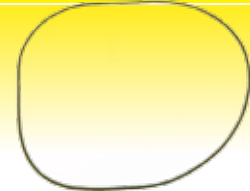

59126

Brake O Ring John Deere Small 40
50 Series

Hand Brake linings

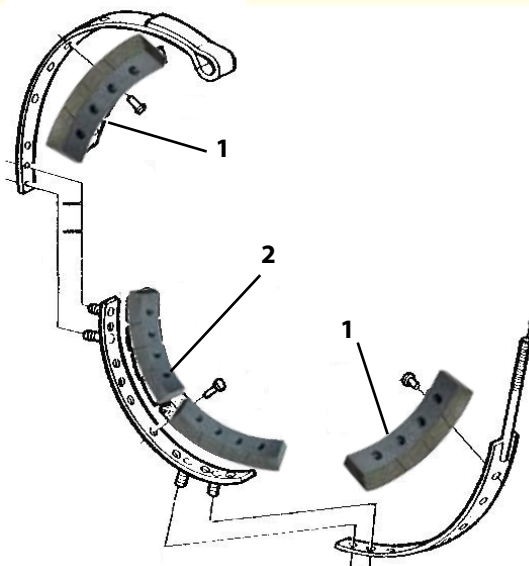

1

58928

OUTER LINING - 3040
3140 3030 3130 3640
3050 3350 3141 3641
2651 2951 3351 3651

SINGLE

OE REF:
L40421

2

58927

INNER LINING - 3040 3140
3030 3130 3640 3050
3350 3141 3641 2651
2951 3351 3651

SET OF 2

OE REF:
L40422

Rivets 5x25mm - 58794



58929

830 930 1030 1130 1630 940
10440 1140 1550 1750 1850
1850N 1350 1950 1950N 2250
2450 2650

SET OF 4

OE REF:
L40420

Hydraulic Pumps 20/30/40/50 Series

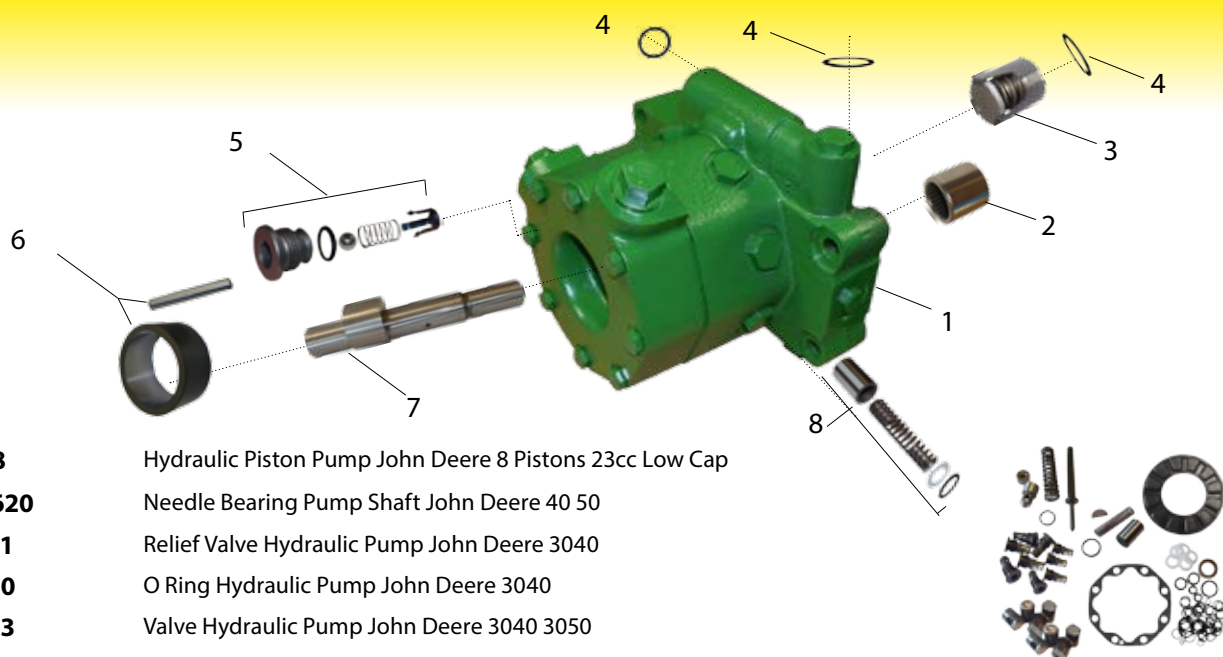

- 1. **2488** Hydraulic Piston Pump John Deere 8 Pistons 23cc Low Cap
- 2. **BH1620** Needle Bearing Pump Shaft John Deere 40 50
- 3. **59221** Relief Valve Hydraulic Pump John Deere 3040
- 4. **59220** O Ring Hydraulic Pump John Deere 3040
- 5. **59223** Valve Hydraulic Pump John Deere 3040 3050
- 6. **59219** Bearing Shaft Hydraulic Pump John Deere 3040
- 7. **59276** Hydraulic Pump Shaft John Deere 20 2040
- 8. **59222** Piston Kit Hydraulic Pump John Deere 3040 305

58941
Repair Kit Hydraulic Piston Pump John Deere 3040 3050 1040 2030 2040 2650 2850 ** To suit 2488 Pump ** [AL71016](#)



59130
Drive Shaft Hydraulic Piston Pump
John Deere 1040 2030 2040 2140
2650 2850 **Suits 2488 Pump**



59131
Rubber Cushion Hydraulic Piston Pump
John Deere 3040 3050 1040 2030 2040
2140 2650 2850 **Suits 2488 Pump**



58956
Drive Shaft Hydraulic Pump John Deere
3050 3350 3650 [OE Ref: L42188](#)

58668
Hydraulic Pump John Deere 40
50
Pump Output 40 cm³



780174
Hydraulic Pump John Deere
3100 3200 3300 3400
[OE Ref: RT7700036171](#)



59217
Hydraulic Pump John Deere 4040 4240 4440 4050
Pump Output 50 cm³



59211
Hydraulic Pump John Deere 20 30 40 50
Pump Output 65 cm³



59603
Seal Kit John Deere Hydraulic Pump 4040 4240 4440 4050 ** Pump is 59217 **



59602
Seal Kit John Deere Hydraulic Pump 20 30 40 50
Pump is 59211



Hydraulic Parts

59088

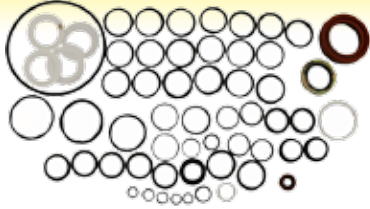

O Ring Kit Hydraulic Pump John Deere
2510 4010 2510 4010 2520 3020 4000
4020 4320 4520 4620 7020 1830 2630
3030 4040 4230 4430 4630

59087

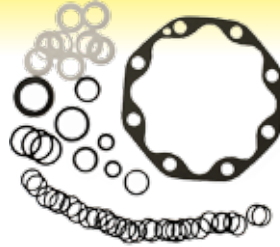

O Ring Kit Hydraulic Pump John
Deere 1140 4430 1850 2040 3340
2250 3350 3050 3650

59086



Bush Kit Hydraulic Pump John Deere
1020 2020 1630 3130

59220

O Ring Hydraulic Pump John Deere 3040
3050 1040 2030 2040 2140 2650 2850 up
to 3040 3050



59219

Bearing Shaft Hydraulic
Pump John Deere 3040
3050 1040 2030 2040 2140
2650 2850 up to 3040 3050

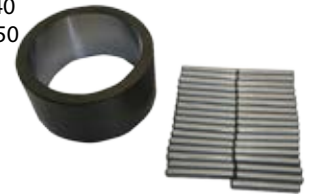

Hydraulic Pump Shafts

59274

Hydraulic Shaft John Deere
2030 2040 2140



59276

Hydraulic Pump Shaft John
Deere 20 2040 Also Fits 2050 30
40 50 55 3040 3050



59275

Shaft Hydraulic Pump John Deere 40 50 55
50CM3 Pump Only



Needle Bearings



BH1620

Needle Bearing Pump Shaft John Deere 40 50 Fits
59276



59594

Needle Bearing John Deere 1020 1120 2020 2120
3120 2440 2640 2150 2255 2750 1030 1140 1640
1840 2040 2040S 2140 2240 3040 3140 3640 840
[OE Ref: JD9858](#)

Hydraulic Pumps

6000/6010/6020/6030 Series

59377

Hydraulic Pump John Deere
6000 6010 - 6610 6020 - 6620
6100 - 6400SE - Pump output
28cm³

OE Ref: AL200830

O Ring=59380

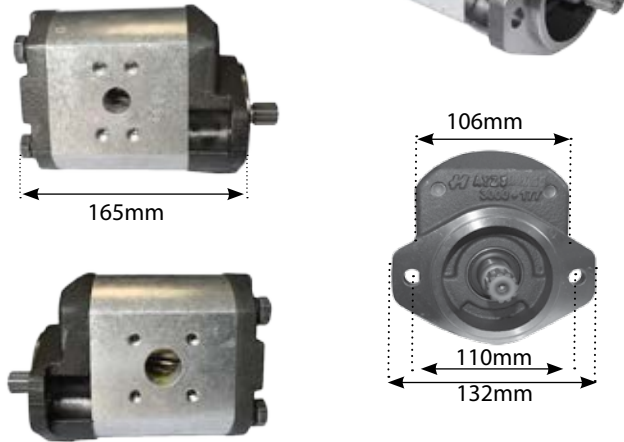

59023



Fitting Kit Hydraulic Pump John
Deere 6100 6010 - 6610

59597



Adaptor Hydraulic
Pump John Deere 6000
Includes Screw

59576

Flange Fitting
Hydraulic Pump
John Deere 600010s
20s 30s



59377R

Hydraulic Pump John Deere 6000
6010 - 6610 6020 - 6620 6100 -
6400SE
Pump Output 28cm³

OE Ref: AL156335



53442 Seal Kit

59592

Elbow Hydraulic Pump
John Deere 6000 6010
6610 6020 - 6620 6100 -
6400SE OE Ref: 38H5019



59593

O Ring Hydraulic Pump
John Deere 6000 6010
6610 6020 6620 6100
6400SE
OE Ref: 51M7047

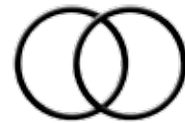

59190

Hydraulic Pump John Deere
5620 5720 5820



Hydraulic Pumps

59204	Hydraulic Pump John Deere 6230 6330 6430 6530 6630 6830 6930 7230 7430 7530 All Premium Models 45cm ³	AL166639
59205	Hydraulic Pump John Deere 6130 6230 6330 6830 6930 28cm ³	AL166637
59191	Hydraulic Pump John Deere 6100 6400 6900 6110 6410 6910 41cm ³	AL161043
59128	Hydraulic Pump John Deere 6100 6400 6900 6110 6410 6910 25cm ³	AL161041

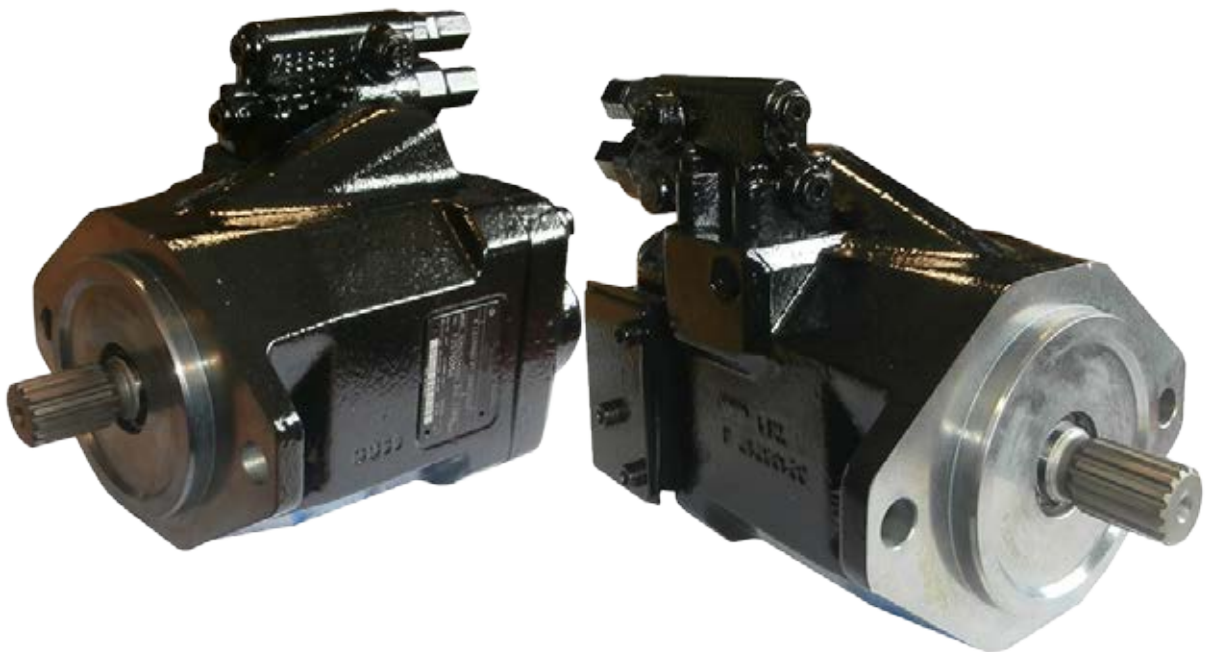

Hydraulic Accessories

4522



Divertor Valve John Deere 2 Way (1/2" BSP)

59989



Kontak End Plate John Deere Closed Centre ** 3116 is O-Ring Kit **

58683



Hydraulic Slice Load Sensing John Deere 6000 6100 6200

59378

Adaptor Hydraulic Pump John Deere 6000 Flange Note: 65mm suits pump 59377 High Capacity



59379



Screw Hydraulic Pump Adaptor John Deere 6000

59262



Hydraulic Adaptor Fitting John Deere 6000 6010

59361

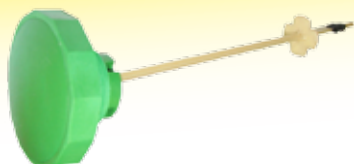

Oil Filler Cap Back End John Deere With Dipst 6100 - 6600 6010 - 6610 6020 - 6620

59277



Cable Spool Valve John Deere 6000 Series 10 20 30 Series

59264



Adaptor Fitting Oil Lines John Deere 6000 6600 6310 - 6910

59555

Selective Control Valve John Deere 2040 3040 3140 3640 2650 3150 3350 ***Blank Side***
OE Ref: AL34593



59554

Selective Control Valve John Deere 1020 2020 2120 820 1030 1630 2030 2130 3130 830 1040 1140 1640 1840 2040 3040 3140 3640 840 1950 OE Ref: AL34595



58992

Selective Control Valve Set John Deere 1020 2020 2120 820 1030 1630 2030 2130 3130 830 1040 1140 1640 1840 2040 3040 3140 3640



6116

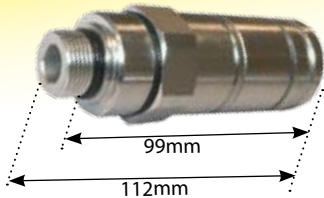

Quick Release Coupling 300 3000
M22 Also for John Deere Ford TS
TM 60
Small Inner Seal=42094

42094



O Ring Outer Small Ford
for 3029G & 6116 10s 30s
40s 60s 70s TM TS TW
7630

59830



Quick Release Coupling
John Deere 10/20's Deluxe
Version

Seal Kit=59628

59628



Seal Kit John Deere Quick
Release Coupling
****Suits 59830****

59359



Seal Kit Quick Release
Coupling John Deere
****SUITS 59830****

58796

Quick Release Coupler
6030/6R/6M Series
TOP
OE Ref: AL210588



58795

Quick Release Coupler
6030/6R/6M Series
BOTTOM
OE Ref: AL210587



58696



Draft Seal John
Deere 40 50 Series
Lower Link 25.5mm
Shaft

58697



Draft Seal John
Deere 40 50 Se-
ries Lower Link
28mm Shaft

59201



Lift Arm Seal
John Deere 6800
6180 6900 6910
7405 7410 7500
7510

59197



Lift Arm Seal John
Deere 6010 6100
6110 6200 6205
6210 6300 6310
6400 6410 6500
6505 6510

59380



O Ring John Deere
For Hydraulic Pump
6000

Linkage Components

Stabilisers

59650

Stabiliser Bracket John Deere
6800 6900 6810 6910 6820 6920
6920s 6830 6930 Not For 6600 or
any 4 Cylinder Models



6 Cylinder

58960

Bracket Stabiliser 6100 6200 6300
6300 6400 6506 6600 6010 6110
6210 6310 6410 6510 6610 6810
6910 6910S 6020 6120 6220 6320
OE Ref: L155798



4 Cylinder

59894

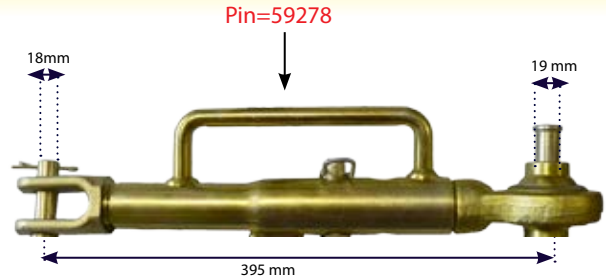

Stabiliser John Deere 6010-6920 Min 16" -
Max21" For SE Models ** Forged F

20mm

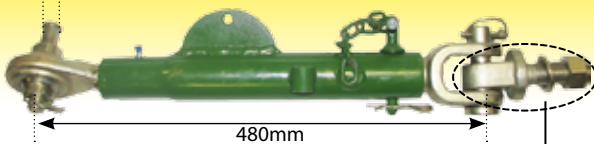

59654

Stabiliser John Deere 6000's H Duty Short
End = 51974



59653

Stabiliser John Deere 6000's H Duty Long

51974

Stabiliser End Threaded John Deere
6000 Serie Heavy Duty Short **SUITS
59654**

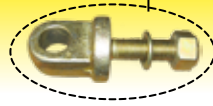

51975

Stabiliser End John Deere 6000
H Duty Long Length: 122mm,
Dia: 24mm



53102

Spring Lower Link Restrainer
Min 17.5" 400mm Max 30" 765mm

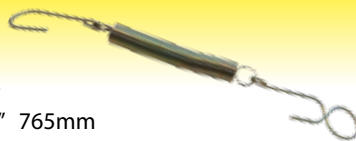

51099

Chain Stabiliser Assembly John Deere 2040 3640



59090

CBM SpA
COSTRUZIONI MECCANICHE



Stabiliser Automatic John Deere 8000 8010 8110
8200 8210 8300 8310 8400 8410

59089

CBM SpA
COSTRUZIONI MECCANICHE



Stabiliser John Deere Automatic 6010 6110 6210 6310 6410
6510 6610 6810 6910 7600 7700 7800 7430PR

59920



Stabiliser John Deere 6000's

59278

Linch Pin Stabiliser John Deere
6000,6010, 60 ***14mm***



Linkage Components

Quick Attach Hooks Cat 2

61227



Quick Attach Hook Kit 390 4200 6200 Cat 2
Also fits John Deere

59035



Repair Kit Lower Link John
Deere Fiat Cat 2

59058



Lever Quick Attach CAT2

63237



Lever Spring Cat 2 Cat 3 Quick Attach

Cat 3

61226



Quick Attach Hook Kit 6200 8200 Cat 3 Also
fits John Deere

59039



Repair Kit Lower Link John Deere Ford Fiat
Case Cat 3

63236



Lever Quick Attach CAT3 With Pin

63237



Lever Spring Cat 2 Cat 3 Quick
Attach

Linkage Components

Levelling Boxes

59280
Pin John Deere Top Arm 20mm 6200 6010
- 6610 6020 6620 ** 30mm Pin 59282,
25mm Pin 59281 **



20mm

59288
Lower Levelling Box
Pin John Deere 6000



20mm

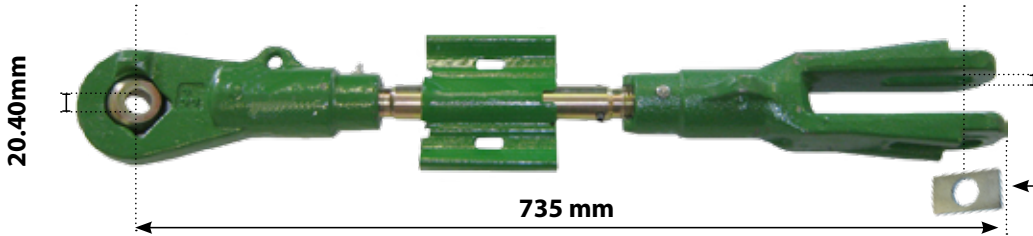

59289
Pin Plate Square John
Deere 6000 20mm Hole

59286
Levelling Box John Deere 6000 RH CAT2 6100 6200 6300 6400 6600

59027
Shaft Levelling Box John Deere 6000 6100 6200 6300
6400 6600 ** Suits 59286 **

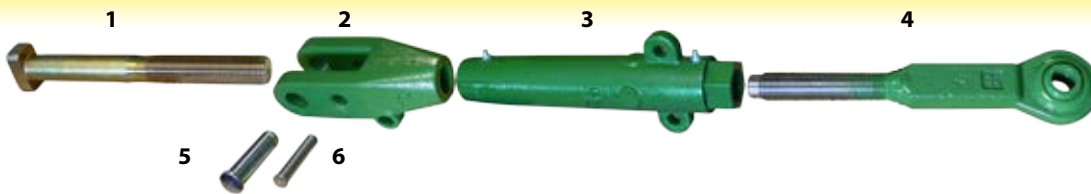

LEVELING BOX PARTS

6800 6900 6810 6910 6910S
7200 7400 7210 7410 7510
7420 7520 7330 8100 8200
8300 8400 8110 8210 8310
8410

1	58868	Lift Link Bolt	OE REF: R106308
2	58867	Lift Link Fork	OE REF: R1178272
3	58865	Lift Link Tube	OE REF: R117616
4	58866	Lift Link End Fork	OE REF: RE55238
5	58864	Clevis Pin 25mm x 93mm	OE REF: R65239
6	58863	Clevis Pin 16mm x 87mm	OE REF: R63737

59285

Levelling Box
John Deere 6000
Cat 2 LH

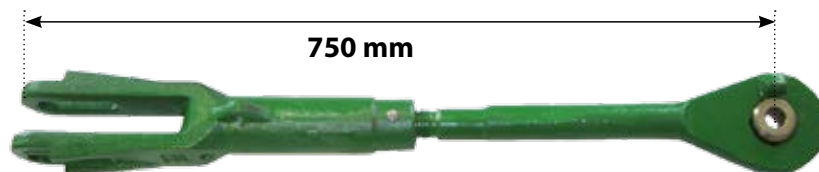

893568



Clevis Pin 165 188 300 690 699
Levelling Box 7/8"

59157



Top Pin Levelling Box 6400 6600
6410 6510 6320 6620

59158



Top Pin Levelling Box John Deere 6800
6900 10 20 30 7430 7530

Linkage Components

Levelling Boxes

59176

Levelling Box John
Deere 6600 6400 Cat 3
6300 6200 6100 6020
730mm - 880mm
Cat 3 870mm-1050mm
59177

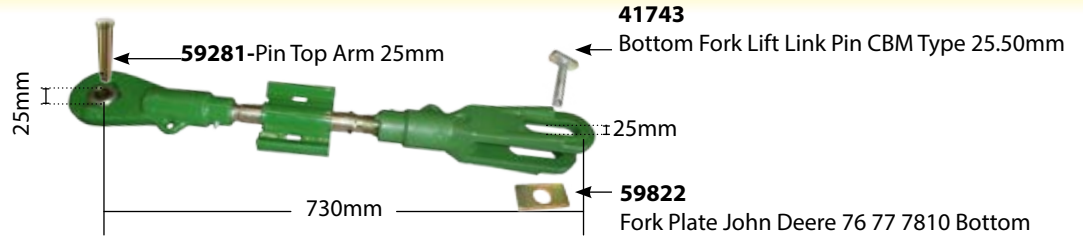

59177

Levelling Box John
Deere 6800 6900 Cat 3
870mm - 1050mm

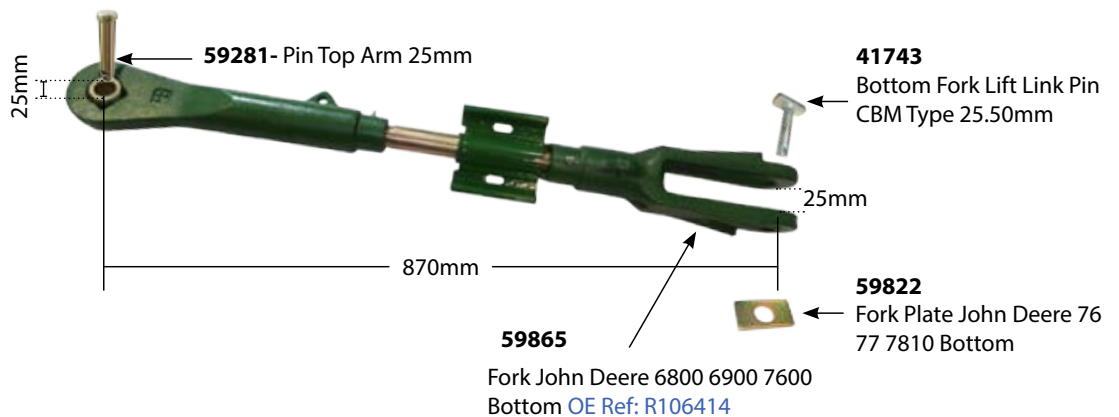

59604

Levelling Box Shaft John Deere 1020 1120 2020 2120 820 2440 2640 2940 2255
2750 2950 30 Series 40 Series 50 Series 2755 3055 3155



59807



Levelling Box Bottom Fork John
Deere 26/2850

59005

Levelling Box Assembly John Deere 1020 1120
2020 2120 820 2440 2640 2940 2255 2750 2950
1030 1130 1530 1630 1830 2030 2130 3030 830

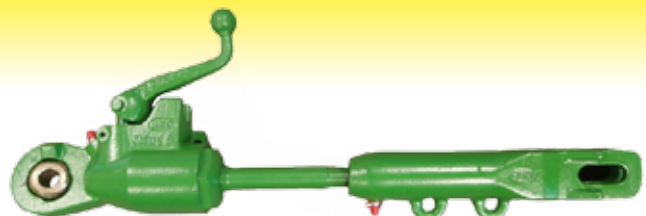

Linkage Components Top Links

2199

Top Link John Deere Cat 2 SuperLink
Tube 15" (Adj. Min 20 9/32" Max 30 3/4")



4115

Top Link John Deere/Fendt CAT 2 SuperLinkTube
19" (Adj. Min 24 3/8" Max 34 7/8")



2458

Top Link John Deere Cat 1 & 2 Heavy Duty
Adj Min 550mm Max 760mm

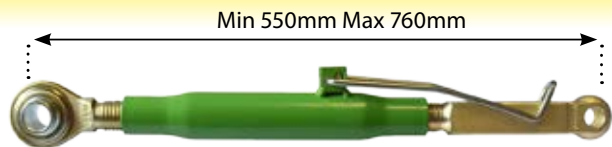

3252

Top Link Assembly John Deere 13" Cat 1 & 2
Adj Min 21 5/8" Max 30"

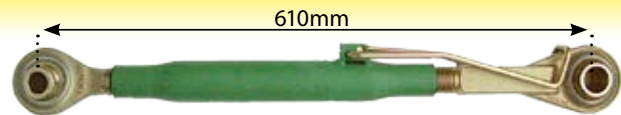

58788

Top Link John Deere Cat 1 Cat 2 Min
550mm

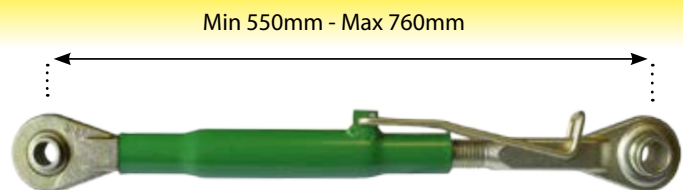

59287

Top Link John Deere 6000 CAT II/II
605mm Centre to Centre
59771 is Budget Version

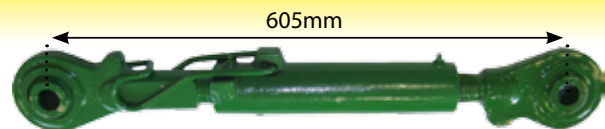

59771

Top Link John Deere 6000 CAT II/II 38mm
23 1/2" (60cm) long (Centre to Centre)

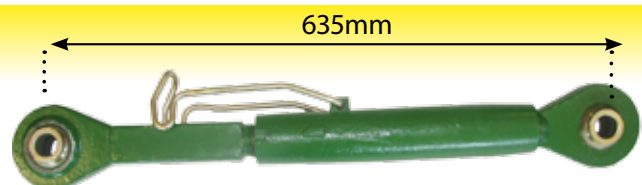

Linkage Components Top Links

59185

Top Link Cat 2 Cat 2 John Deere 6000
** Min 540 Max 690 **

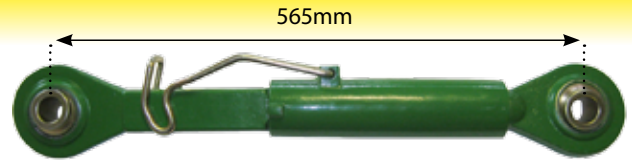

59184

Top Link Cat 2 Cat 3 John Deere 6000
** Min 540 Max 690 **

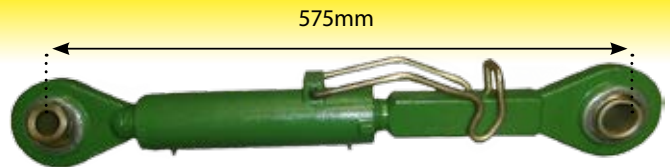

59768

Top Link John Deere 6000 CAT II/III 38mm
24" (61cm) long (Centre to Centre)



59772

Top Link John Deere 6000 CAT III/III
38mm

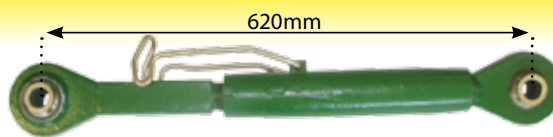

59923

Top Link Knuckle
John Deere

59042

Top Link John Deere 7600 7700 7800
7610 7 7810 7720 7820 7920 7630
7730 7830 7930



Linkage Components

Draft Control



59164
Shaft Load Control John Deere 2040 3050



59127
Bush Load Control
Shaft 2040 3050



58697
Draft Seal J 40 50 Series Lower
Link 28mm Shaft

LOAD CONTROL SHAFT, DRAFT SENSOR

6800 6900 7200 7400 6810 6910 6910S 7210 7410 7510 6820 6920 6920s
6920SE 6830 6930 6140R 6150R 6145R 6155R 6150M 6155M 7420 7520

1	58873	Lower Linkage Bush	R108088
2	58871	Lower Link Sensing Seal	R108086
3	58872	Linkage Shaft Washer	R108095
4	58876	Load Control Shaft	R111186

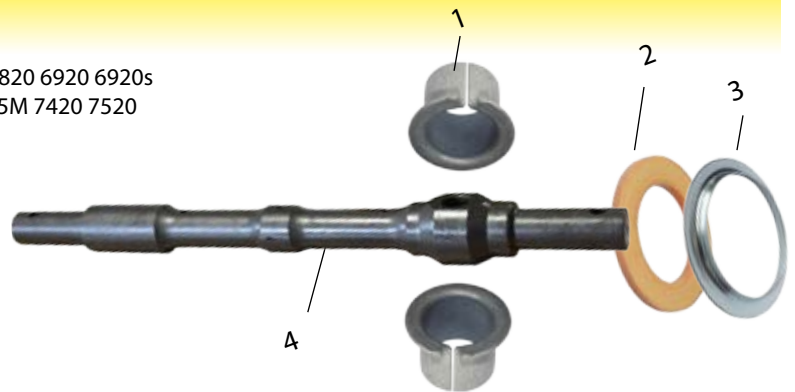

58999
Load Sensing Shaft John Deere 1830 2030
2130 1640 1840 2040 2140 [OE Ref: AL40976](#)



Lower Linkage

58853
Lower Link Shaft John Deere 2750 1830 2030 2130
1640 1840 2040 2140 2350 2550 [OE Ref: L31199](#)



58875
Lower Linkage Pin John Deere 6800 6900
7200 7400 6810 6910 6910S 7210 7410
7510 6820 6920 6920SE 6830 6930 6140R
6150R 6145R 6155R 6150 [OE Ref: R108090](#)

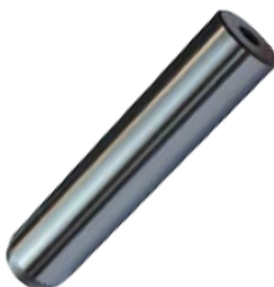

58874
Lower Linkage Bush John Deere 6800 6900 7200
7400 6810 6910 6910S 7210 7410 7510 6820
6920 6920s 6920SE 6830 6930 6140R 6150R
6145R 6155 [OE Ref: R108089](#)

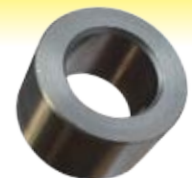

58870
Bearing John Deere 6800 6900 7200 Lower
Linka7400 6810 6910 6910S 7210 7410 7510
6820 6920 6920s 6920SE 6830 6930 6140R
6150R 6145R 6155 [OE Ref: AT128773](#)



Linkage Components

Lift Assist Components

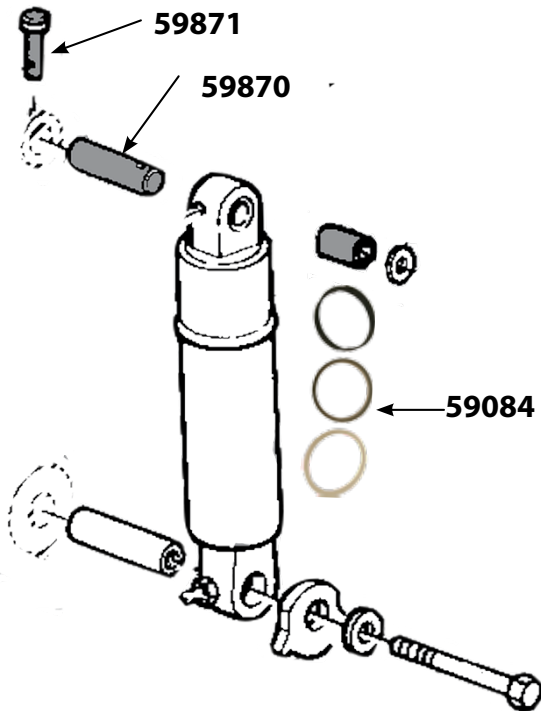

59871
Lift Cylinder Retainer Pin John
Deere 6810/69



59870
Lift Cylinder Pin John Deere 6800 6900
Upper 6810 6910 6910S 7600 7700 7800



59084
Hydraulic Cylinder Kit John Deere 7600
7700 7800 7200 7400 7210 7410 7510
7610 7710 7810 6800 6900 6810 6910
6910S



58860
Hydraulic Cylinder Seal Kit John Deere 6300 6400 6600
6310 6410 6510 6610 6810 6910 6910S 6510SE 6610SE
6320 6420 6520S 6520 6620 6820 [OE Ref: AL208000](#)

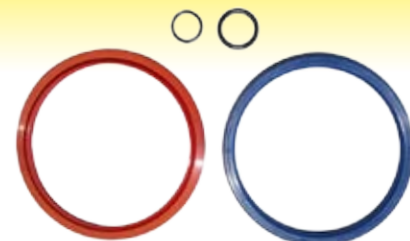

Lift Arms & Hydraulic Lift Rock Shafts

59203
Lift Arm JLH Cat 3
6800 6180 6900
6910 7405 7500

59156 - Rocker Shaft 6800 6180 6900 6910 7405 7500

59201
Lift Arm Seal John Deere
6800 6180 6900 6910 7405 7410 7500 7510

59202
Lift Arm JD RH Cat 3
6800 6180 6900 6910
7405 7500

58910
Sensor Rockshaft Position John
Deere 10 6000, 6010, 6020, 6030,
7030, R, M series
OE Ref: L172758

59195
Lift Arm LH JDDeere 6810S
6820S 6910S
SE6920 6830 Premium 6930
Premium 7730 Premium

59193
Shaft Hydraulic Lift Rock Shaft
John Deere

59194
Lift Arm RH JDDeere 6810S 6820S 6910S
SE6920 6830 Premium 6930 Premium
7730 Premium

59199
Lift Arm LH Cat 3
OE Ref: L114583 L79946

59200
Hydraulic Lift Rock Shaft
OE Ref: L152475

59198
Lift Arm RH Cat 3
OE Ref: L114584 L79947

59197
Lift Arm Seal John Deere
OE Ref: L79230

59344
Bushing Rocker Shaft John
Deere 6010 6100 6110 6200
6205 6210 6300 6310 6400
6410 6500 6505 6600 6610
OE Ref: L79234

53807
Bolt M12 x 25

59590
Washer Lift Arm John Deere
6010 6100 6110 6200 6205
6210 6300 6310 6400 6410
6500 6505 6606 6610
OE Ref: L77320

Lower Links Balls

<p>53041 Cat 1/2</p> <p>Lower Link Ball Dual Cat 1/2</p> 	<p>62228 Cat 2/2</p> <p>Ball Cat 2/2 For Lower Quick Release End</p> 	<p>2539 Cat 3/2</p> <p>Lower Link Ball Cat 3/2 ID 29 OD 63.5</p> 	<p>2540 Cat 3/3</p> <p>Lower Link Ball Cat 3/3 ID 37.5mm OD63.5mm</p> 	
<p>4418 Cat 2</p>  <p>Link Ball Lower c/o Guide Cone Cat 2</p>	<p>4727 Cat 3/3</p>  <p>Link Ball Cat 3/3 & Guide Cone</p>	<p>4729 Cat 2/3</p>  <p>Link Ball Cat 2/3 & Guide Cone</p>	<p>4419</p>  <p>Linch Pin for 4418 12mm Diameter Pin</p>	<p>53057</p>  <p>Linch Pin & Grip Clip Assortment Pack Qty 50</p>



Lower Link Conversion Bushes

<p>2424</p> <p>Cat 1 to Cat 2</p>  <p>Lower Link Conversion Bush 1 1/8' to 7/8'</p>	<p>43155</p> <p>Cat 2 to Cat 3</p>  <p>Bush Lower Link Conversion Cat 2 to Cat 3</p>	<p>53496</p> <p>Cat 2 to Cat 3</p>  <p>Bush Lower Link Conversion Cat 2 to Cat 3 ID 1 1/8" OD 1 7/16" Length 2 1/2" 63.5mm</p>
--	---	---

Top Links Balls

<p>21018</p> <p>Top Link Ball Cat 2/3</p> <ul style="list-style-type: none"> • I/D Ø: 1" • O/D Ø: 2 23/64" • WIDTH: 2" <p>Cat 2/3</p> 	<p>21019</p> <p>Top Link Ball Cat 3/3</p> <ul style="list-style-type: none"> • I/D Ø: 1 9/32" • O/D Ø: 2 23/64" • WIDTH: 2" <p>Cat 3/3</p> 
<p>4044</p> <p>Top Link Ball CAT 2</p> <p>Cat 2/2</p> 	<p>21001</p> <p>Ball Cat 3 Toplink</p> <p>Cat 3</p> 

Top Link Conversion Bushes

<p>53475</p>  <p>Bush Top Link Conversion Cat 2 Cat 3</p>	<p>42144</p>  <p>Top Link Conversion Bush Ford 10 100 Cat 1/2 1000 30 40 Industrial TW Series</p>
---	--

Linkage Arm Cat 2 John Deere 6100 6200 63 6400 6506 6600 6010 6110 6210 6215 6310 6410 6510 6610 6020 6120 6220 6320 6420 6520 6620

58857	Right Hand	OE REF: AL117717
58858	Left Hand	OE REF: AL117716
58859	Weld On Linkage End	OE REF: AL117727

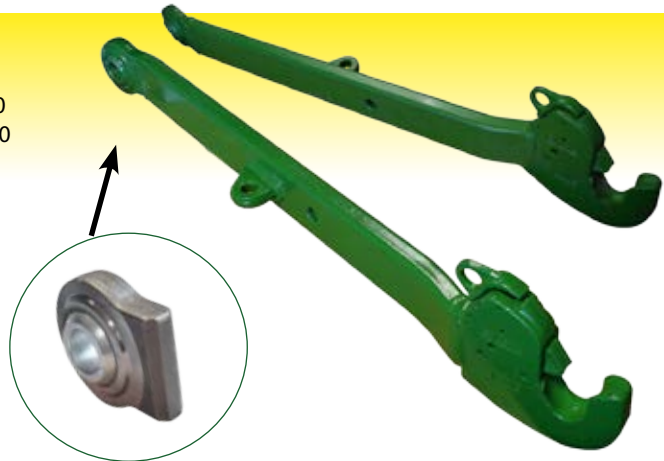

Quick Release Ends



CAT 2

41734

Quick Release End CBM type
Weld On Cat 2

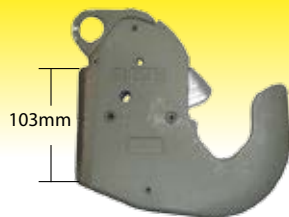

41735

Quick Attach Hook
Kit CBM Cat 2



CAT 2S

41773

Quick Release End CBM CAT 2S
Weld On LH+RH

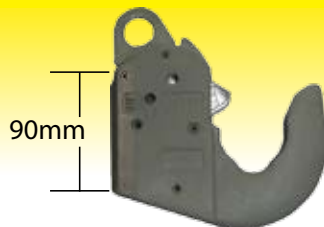

53839

Quick Attach Hook Kit Cat 2S
Cat 2s



CAT 3

53381

Quick Release End CBM Weld
On Cat 3

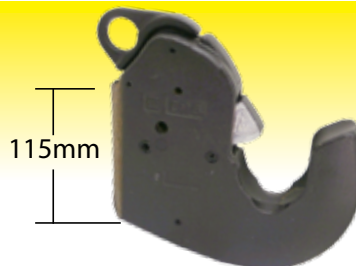

41736

Quick Attach Hook Kit CBM
Cat 3



CAT 4

64444

Weld On Quick Attach Hook
OE Ref: 3905500M91



53836

Cat 4 Quick Attach
Hook Kit CBM



41739

Eye bolt Ring Quick Re-
lease Chain 3000 5400



41746

Chain For Quick
Release CBM Type

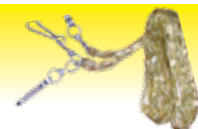

Linkage CBM Type

59289

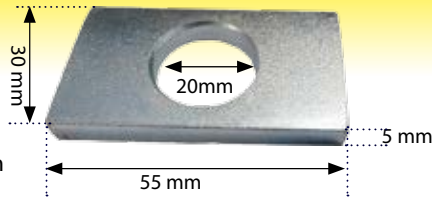

Pin Plate Square John
Deere 6000
20mm Hole

59288

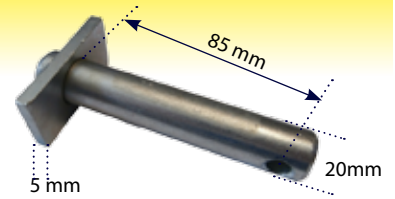

Lower Levelling Box
Pin John Deere 6000

41747

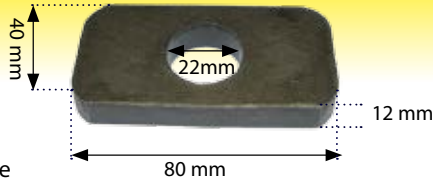

Bottom Fork Plate
CBM Type 22mm

41748

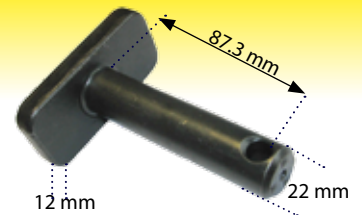

Bottom Fork Lift Link Pin
CBM Type 22mm

59822

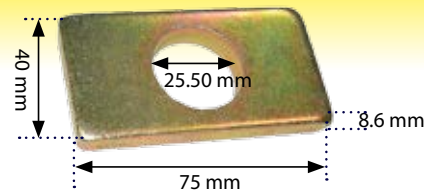

Fork Plate John
Deere 76 77 7810
Bottom

41743

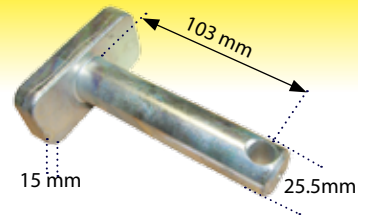

Bottom Fork Lift Link Pin
CBM Type 25.50mm

41740

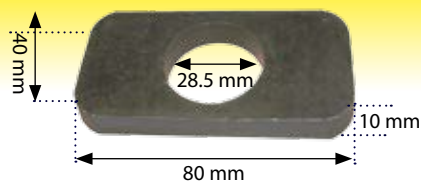

Bottom Fork Plate CBM
Type 28.5mm hole

41741

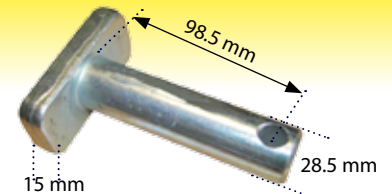

Bottom Fork Lift Link Pin
CBM Type 28.5mm

41744

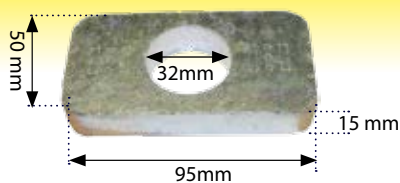

Bottom Fork
Plate CBM Type
32mm hole

41745

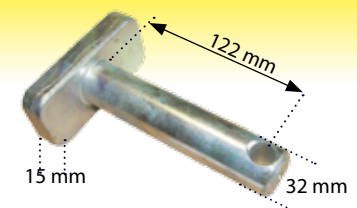

Bottom Fork Lift Link
Pin CBM Type 32mm

6000-6620 Hitch Parts

DRSP6046

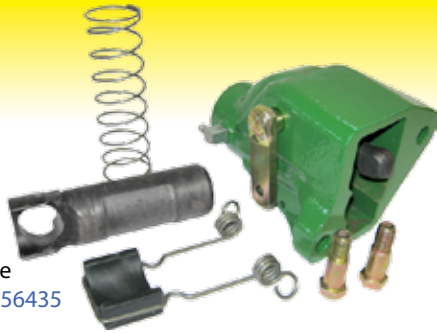

Lock Housing Kit
Dromone John Deere
Complete OE Ref: L156435

DRP00331

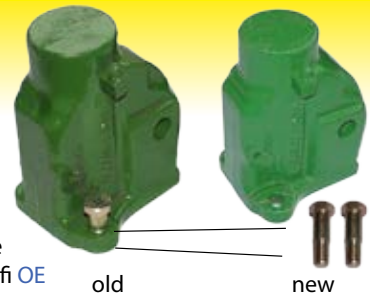

Lock Housing Dromone
John Deere 2 Bolt Modifi OE
Ref:AL164091

DRP00332

Lock Housing Protector
Bracket John Deere



DRP57536

Screw Dromone John Deere
M10 (Length 39mm)



part of kit DRSP6046

DRP57005

Spring John Deere



part of kit DRSP6046

DRP57651



Lever Housing John Deere

part of kit DRSP6046

DRP48856



Lock Housing Pin John Deere
MK111 30.2mm pin
OE Ref: L115561

part of kit DRSP6046

DRP57004

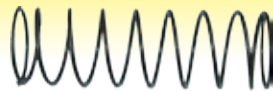

Spring John Deere

part of kit DRSP6046

DRP78100



Safety Assy. Spring John
Deere

part of kit DRSP6046

DRP78101



Release Assy. Handle John
Deere

part of kit DRSP6046

DRP00519

PTO Guard Assembly John Deere



58879

PTO Guard Kit John Deere 7200R 7215R
7230R 7260R 7280R 7210R 7230R
7250R 7270R 7290R7310R
OE Ref: R307633

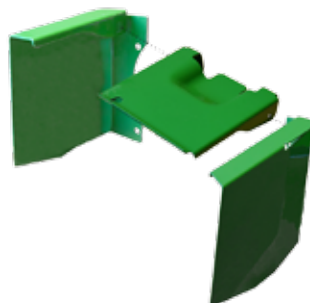

58838

Hitch Handle John Deere 6000 Series
6010 Series 6020 Series 6030 Series
OE Ref: AL78708



Complete Hitches

DRA3278

Hitch John Deere 7600-7810
Hyd Push Back JD MR Series Lock
Housing Type



DRP55101

Locking Spigot John Deere
- PAIR



DRP48810



Drop In Pin

DRP48832

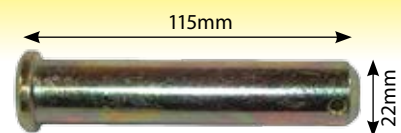

Drop In Pin

DRP48818

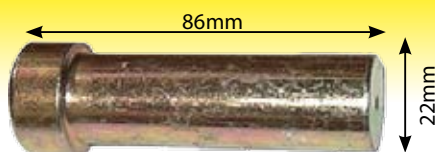

Drop In Pin - 2 Pin Type Push Back

DRP48840

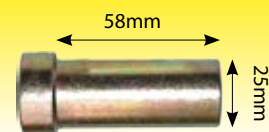

Drop Pin John Deere (1 pin type push bac
Pin=DRP48840

K80 RANGE

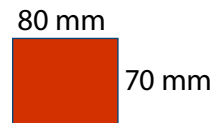
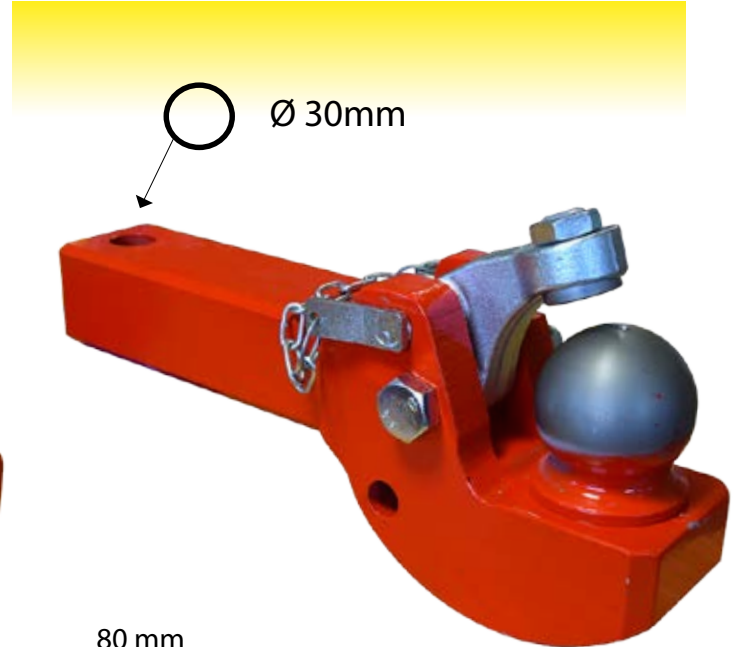
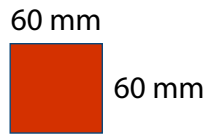
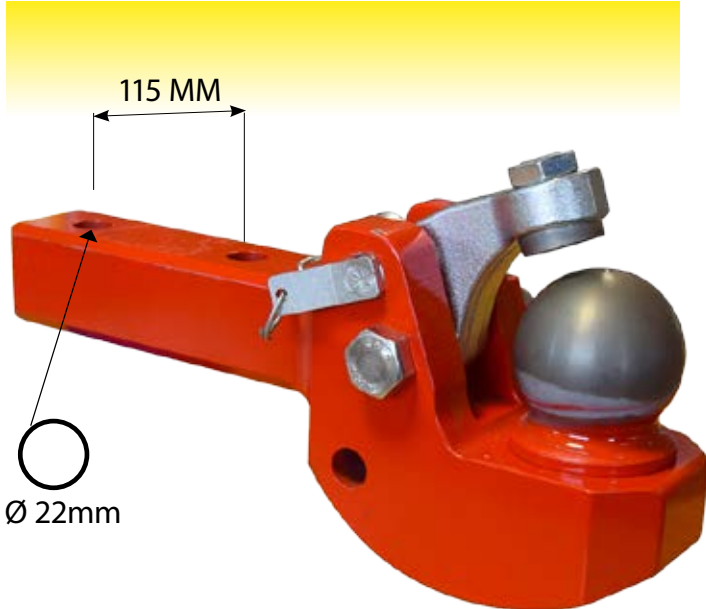

58883 OE Ref: 00.421.10.2-A20

Claas: Ares 500/600 Arion 500/600
Fendt: Vario 200/300
John Deere: 7010, 8000
Massey Ferguson: 5600 6445-6480 7600

58884 OE Ref: 00.429.00.2-A20

Claas: Axion 800/900
Fendt: Vario 700/800/900
John Deere: 8030/8R
Massey Ferguson: 6485-6499, 6485-6499, 7624, 7626, 8200: 8210, 8280; 8400
McCormick: MTX: 165, 175, 185;
Valtra: S-Series

INTERCHANGEABLE WITH

DRSP30033
oe ref: L156433



INTERCHANGEABLE WITH

DRP47902
oe ref: L156433



58837 Oe Ref: 00.651.90.0-A01

K80 Weld On Spoon Universal

**ALLOWS TRANSMISSION OF HIGHER VERTICAL LOADS
 PLAY - FREE CONNECTION, ELIMINATES RATTLE
 GREATER ANGULAR MANEUVERABILITY
 QUIETER TOWING
 NO UPWARD MOVEMENT FOR TIPPING TRAILERS - RESULTS IN LESS WEAR**

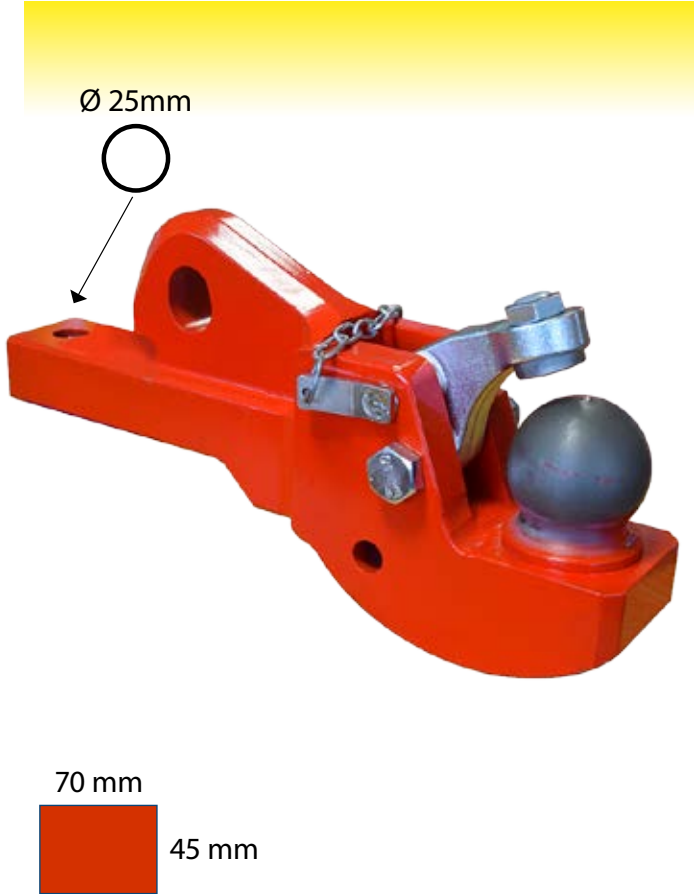

58886 Oe Ref: 00.428.00.5-A20
 John Deere: 6010, 6020, 6130, 6R, 7020, 7030, 8010, 8020, 8030

**INTERCHANGEABLE
 WITH**

DRP00515
 oe ref: L156433,
 AL159328

DRP82406
 oe ref: AL159328,
 L156433



53829 Oe Ref: 00.652.90.0-A02



K80 Towing Spoon 110 x 100mm

53828
 K80 Weld On Plate 110 x
 100mm



53853
 Bolt Kit M16 x 60mm
 10.9 Strength



53827 Ref: 00.650.90.1-A02



K80 Towing Spoon 145 x 145mm

53830
 K80 Weld On Plate
 145 x 145mm
 OE REF: 00.645.00.0



53854
 Bolt Kit M20 x 80mm
 10.9 Strength



Dromone Hitch Components

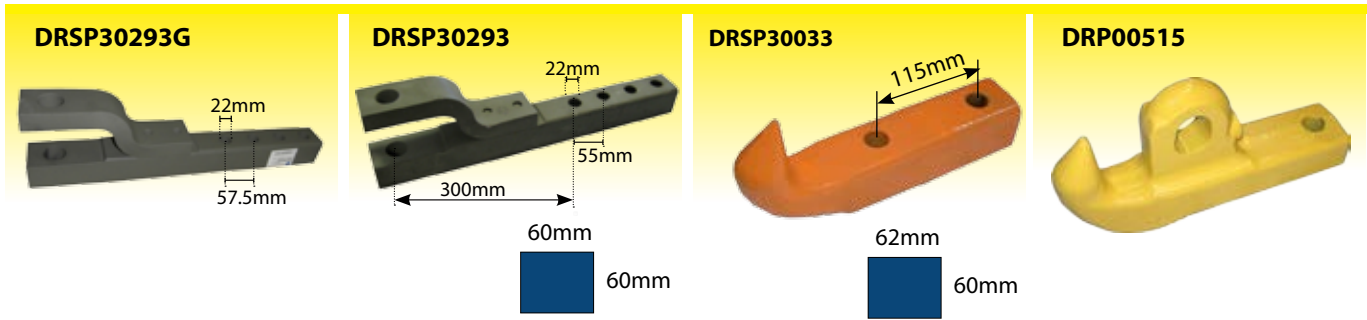

DRSP30293G
Drawbar Assembly ISO 57.5mm
centre to centre

DRSP30293
Drawbar Assembly ISO

DRSP30033
Pick Up Hitch Hook ISO
60mm 115mm btw Holes

DRP00515
Pick Up Hitch Hook John
Deere
Pin=DRP48840



DRP47901
Pick Up Hitch Hook
Dromone Head -
60mm

DRP82406
Drawbar Assembly Kit Dr-
omone John Deere

61215
Pick Up Hitch Hook Heavy Duty

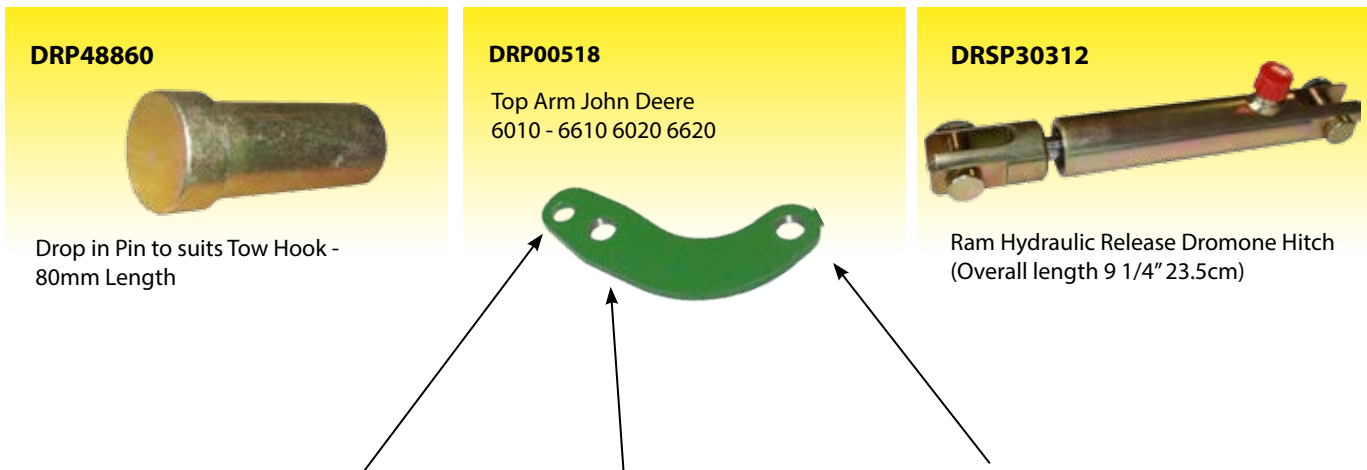

DRP48860
Drop in Pin to suits Tow Hook -
80mm Length

DRP00518
Top Arm John Deere
6010 - 6610 6020 6620

DRSP30312
Ram Hydraulic Release Dromone Hitch
(Overall length 9 1/4" 23.5cm)

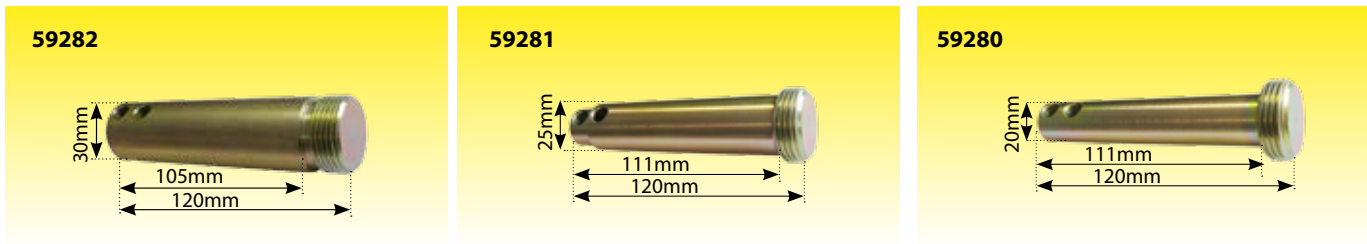

59282
Pin John Deere Top Arm 30mm 6200
6010 - 6610 6020 6620

59281
Pin John Deere Top Arm 25mm 6200
6010 - 6610 6020 6620

59280
Pin Top Arm 20mm John Deere
6200 6010 - 6610 6020 6620

Pick Up Hitch Cables

59912



Pick Up Hitch Cable John Deere 6000 6010 6020
For Lock Housing Type Hitch
Cable for Early 6100 - 6900 is 59910

59910



Pick Up Hitch Cable John Deere 6100-6900
For Latching Hook Type Hitch
Up to serial number 135118
Late Type cable is 59912

59094



Pick Up Hitch Cable John Deere 6140R 6150R 6140R
6150R 6170R 6190R 6210R Series

59622

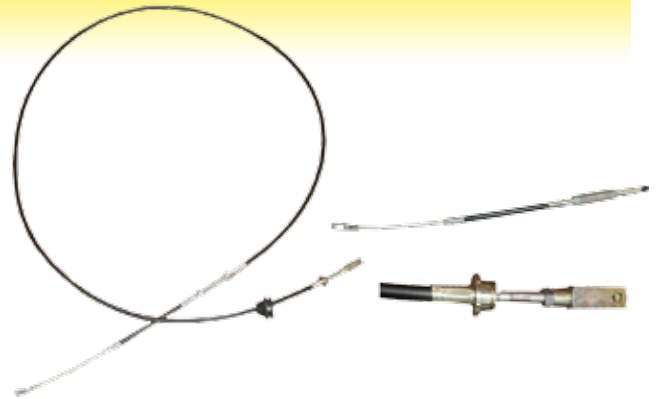

Pick Up Hitch Cable John Deere 7530 7430

59336

Cable Loader John Deere 531 - 551 533 - 583 631-
651- 661 633 - 653 - 663 731 - 751



59245

Clevis End
John Deere



59248

Clevis End Safety Pin
John Deere



59613

Clevis End Kit John Deere



Hitch Components

DRP00520

Liftrod John Deere 6020 6 Cylinder **Not for Dromone** - Sauer mann '05 on 6620 6820 6920 6920S



58695

Slide Pipe 4 Cyl John Deere 6030 LH
Fits Sauer mann Hitch



58694

Slide Pipe Saurman 4 Cyl John Deere 6030
Fits Sauer mann Hitch



58985

Slide Pipe John Deere 6830 6930
6820 6920 KIT Lift Rod & Nut



59636

Lift Rod John Deere 6020 - 6620 & SE Models
From Serial Ref 401618 -> Sauer mann 4 Cyl - L



58674

Lift Rod John Deere 6020 - 6620 & SE Models 20mm
** 25mm Lift Rod is 59636 **

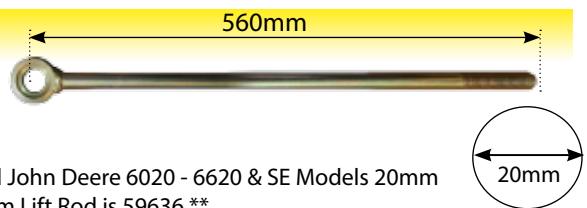

Nut= DRP44341

DRP79045

Slide Pipe John Deere 6800 6900 6810 6910 6820 6920
** KIT IS 58985 ** Suits all type of JD Dromone Housing
Pre '05



25 mm

DRP79032

Lift Rod John Deere 6810-6910
6800 6900 6820 6920 New Dr-
omone Type



Nut= DRP44341

Hitch Components

DRP00512



Slide Pipe John Deere 6000 4 Cylinder LH 6010 - 6610 Series 6020 - 6620 Series 5620 5720 5820

DRP00513

Slide Pipe John Deere 6000 - 6600 RH 6010 - 6610 Series 6020 - 6620 5620 5720 5820 Dromone 4 Cylinder

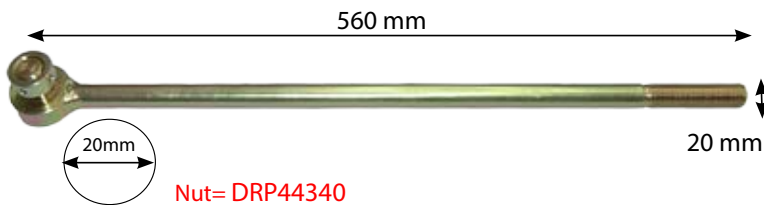

DRP00001

Lift Rod Assembly John Deere & Bushing 20mm 6000 - 6600 6010 - 6610 6020 - 6620 SE **59636 is for the later type - From 401618**

DRP79046

Nut= DRP44341

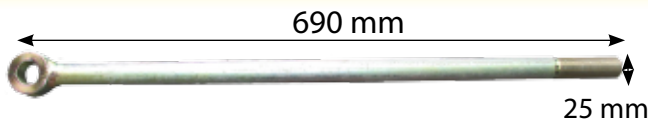

Lift Rod John Deere 7600 7700 7800 7610 7710 7810 Dromone Pre '05

DRSP75292P

Nut= DRP44341



Lift Rod John Deere 6830 6930 6820 6920 Also Fits 6810 6910 ** 25mm **

Nut Lift Rods

DRP44340

Nut Lift Rod 20 mm

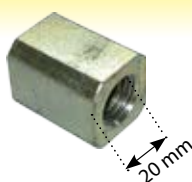

DRP44341

Nut Lift Rod 25mm



DRP43206

Nut spacer Lift Rod 30mm (No Thread)

