

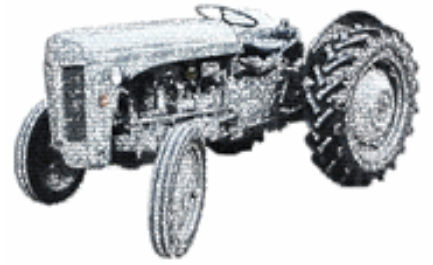

L.O.G Heigl



RELIANCE

ENGINE PARTS CATALOGUE

Cummins B Engine Parts Suitable For

Case IHC



Replacement Parts Suitable For

John Deere Tractors



NEF (New Engine Family) Parts for

Ford New Holland



John Deere Index

Model	Pg.	Engine
1640	4	4-239D
1840	4	4-239D
2040S	4	4-239D
2130	4	4-239D, 4-276D, 4-276T
2135	4	4-239D
2140	6	4-239T
2250F	4	4-239D
2350	4	4-239D
2355CS	4	4-239D
2450	4	4-239D
2450F	4	4-239D
2535	4	4-239D
2550	4	4-239D
2555	6	4-239T
2555TSS	6	4-239T
2650	6	4-239T
2650F	6	4-239T
2650N	6	4-239T
2730	4	4-239D
2735	4	4-239D
2750	6	4-239T
2755	6	4-239T
2755CS	6	4-239T
2755TSS	6	4-239T
2850	6	4-239T
2855	6	4-239T
2855N	6	4-239T
2940	8	6-359D
2950	8	6-359D
2955	8	6-359D
3020	4	4-239D, 4-270D
3040	10	6-359T,A
3050	8	6-359D
3055	8	6-359D
3140	10	6-359T,A
3140C	10	6-359T,A
3150	8	6-359D
3155	8	6-359D
3155TSS	8	6059D, 6-359D
3210	8	6-359D
3255	10	6-359T,A
3300		4045D
3310	20	4045D Powertech
3310X	20	4045D Powertech
3330	4	4-239D

Model	Pg.	Engine
3350	10	6-359T,A
3400	12	4039T
3410	22	,H Powertech
3410X	22	4045T,H Powertech
3540	10	6-359T,A
3550	10	6-359T,A
3640	8	6-359D
3650	10	6-359T,A
4040	8	6-359D, 6-404D
4050	10	6-359T,A 6-466D"
4050E		6-466T
4250		6-466T
4280	8	6-359D
4350		6-466T
4440		6-466T
4450		6-466T
4485		6-466T
4530	8	6-359D
4685		6-466T
4890	22	4045T,H Powertech
4920		6081A,H Powertech
5410	20	4045D Powertech
5415	20/22	4045D Powertech 4045T, H Powertech
5420N	20	4045D Powertech
5500	6	4-239T
5500N	12	4039T
5510	22	4045T,H Powertech
5510N	22	4045T,H Powertech
5520N	22	4045T,H Powertech
5615	20	4045D Powertech
5700	12	4039T
5715	28	4045T,H Powertech High Horsepower
5820	28	4045T,H Powertech High Horsepower
6010	20	4045D Powertech
6010SE	20	4045D Powertech
6020	20	4045D Powertech
6020SE	20	4045D Powertech
6100		4045D
6100SE		4045D
6020	20	4045D Powertech
6110	28	4045T,H Powertech High Horsepower
6110L	28	4045T,H Powertech High Horsepower
6110SE	28	4045T,H Powertech High Horsepower
6120	28	4045T,H Powertech High Horsepower
6120SE	28	4045T,H Powertech High Horsepower
6200	12	4039T

John Deere Index

Model	Pg.	Engine
6200L	12	4039T
6200SE	12	4039T
6205	22	4045T,H Powertech
6210	28	4045T,H Powertech High Horsepower
6210L	12	4039T
6210SE	28	4045T,H Powertech High Horsepower
6215	28	4045T,H Powertech High Horsepower
6220	28	4045T,H Powertech High Horsepower
6220SE	28	4045T,H Powertech High Horsepower
6300	12	4039T
6300L	12	4039T
6300SE	12	4039T
6310	28	4045T,H Powertech High Horsepower
6310L	28	4045T,H Powertech High Horsepower
6310S	28	4045T,H Powertech High Horsepower
6310SE	28	4045T,H Powertech High Horsepower
6320	28	4045T,H Powertech High Horsepower
6400	12	4039T 4045T,H
6400L	14	4045T,H
6410S	28	4045T,H Powertech High Horsepower
6410SE	28	4045T,H Powertech High Horsepower
6415	28	4045T,H Powertech High Horsepower
6420	28	4045T,H Powertech High Horsepower
6500	12	4039T
6500L	14	4045T,H
6505	17	6059T
6506	17	6059T
6510	20/24	4045D Powertech
6510L	28	4045T,H Powertech High Horsepower
6510S	28	4045T,H Powertech High Horsepower
6510SE	24	6068D Powertech
6515	24	6068D Powertech
6520	24	6068D Powertech
6520SE	24	6068D Powertech
6600	17	6059T
6603	18	6068T,H Powertech
6605	30	6068T,H Powertech High Horsepower
6610	30	6068T,H Powertech High Horsepower
6610SE	30	6068T,H Powertech High Horsepower
6615	30	6068T,H Powertech High Horsepower
6620	30	6068T,H Powertech High Horsepower
6715	30	6068T,H Powertech High Horsepower
6800	18	6068T,H
6810	28	4045T,H Powertech High Horsepower
6820	30	6068T,H Powertech High Horsepower
6900	18	6068T,H
6910	30	6068T,H Powertech High Horsepower

Model	Pg.	Engine
6910S	30	6068T,H Powertech High Horsepower
6920	30	6068T,H Powertech High Horsepower
6920S	30	6068T,H Powertech High Horsepower
7200	17	6059T
7210	30	6068T,H Powertech High Horsepower
7400	18	6068T,H
7405	30	6068T,H Powertech High Horsepower
7410	30	6068T,H Powertech High Horsepower
7420	30	6068T,H Powertech High Horsepower
7500	30	6068T,H Powertech High Horsepower
7510	30	6068T,H Powertech High Horsepower
7520	30	6068T,H PowertechHighHorsepower6-531A
7600	18	6068T,H
7610	30	6068T,H Powertech High Horsepower
7700	33	6076T, A, H
7710	34	6081A,H Powertech
7800	33	6076T, A, H
7810	34	6081A,H Powertech
7820	34	6081A,H Powertech
7920	34	6081A,H Powertech
8100	33	6076T, A, H
8100T	34	6081A,H Powertech
8110	34	6081A,H Powertech
8110T	34	6081A,H Powertech
8120	34	6081A,H Powertech
8120T	34	6081A,H Powertech
8200T	34	6081A,H Powertech
8210	34	6081A,H Powertech
8210T	34	6081A,H Powertech
8220	34	6081A,H Powertech
8220T	34	6081A,H Powertech
8300T	34	6081A,H Powertech
8310	34	6081A,H Powertech
8310T	34	6081A,H Powertech
8320	34	6081A,H Powertech
8320T	34	6081A,H Powertech
8400	34	6081A,H Powertech
8400T	34	6081A,H Powertech
8410	34	6081A,H Powertech
8410T	34	6081A,H Powertech
8420	34	6081A,H Powertech
8420T	34	6081A,H Powertech
8520	34	6081A,H Powertech
8520T	34	6081A,H Powertech
9100	34	6081A,H Powertech
9120	34	6081A,H Powertech
942	4	4-239D
945	6	4-239T
952	6	4-239T

4-239D Engine

300 Series 239 inches 4 Cylinders

Engine Overhaul Kits

	Part No.	Description	92000 Standard Overhaul Kit	92010 .010" Kit	92020 .020" Kit	Bore
1	QRE30250	Cylinder Kit*	4	4	4	106.5
1A	QAR65507	O Ring Kit	4	4	4	
2	QRE501579	Gasket Set	1	1	1	
3	QAR67942	Seal Front	1	1	1	
4	QR78598	Thrust Washer for Flange-less Bearing	4	4	4	
5	QR57160	Balance Bush	6	6	6	
6	QR55647	Rod Bush	4	4	4	
7	QRE44574	Seal Rear	1	1	1	
8	QAR81786	Thrust Bearing STD	1			
9	QRE27348	Rod Bearing STD	4			
10	QRE27352	Main Bearing STD	4			
11	QAR81788	Thrust Bearing 10 Thou		1		
12	QRE27349	Rod Bearing 10 Thou		4		
13	QRE27353	Main Bearing 10 Thou		4		
14	QAR81789	Thrust Bearing 20 Thou			1	
15	QRE27358	Rod Bearing 20 Thou			4	
16	QRE27360	Main Bearing 20 Thou			4	

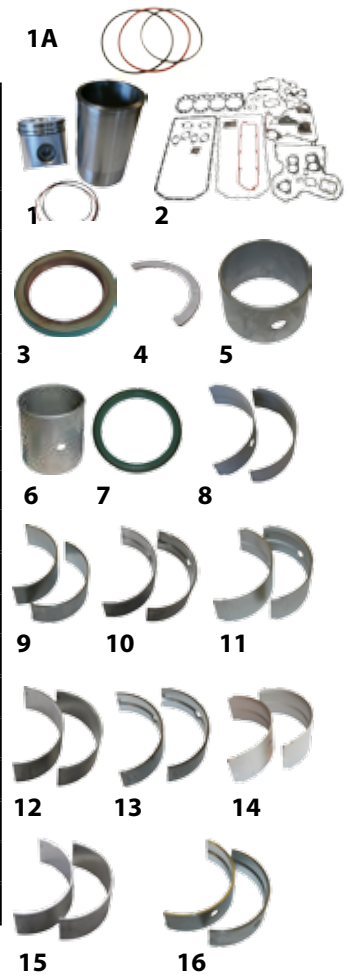

*Head Set QRE38851 Contains		
R73521-B	Gasket, Rocker Cover, 4 Cyl	1
R97354-B	Gasket, Inj Pump Mount	1
R105346-B	Gasket, Turbo Oil Outlet	1
R97348-B	Gasket, Turbo Oil Inlet	1
R89879-B	Gasket, Turbo Mount	1
R56463-B	O-Ring, Vent Tube Outlet	1
R54641-B	Gasket, Thermostat to Cyl Head	1
R54638-B	Gasket, Thermostat Cover, Dual	1
R48000	Seal, Pencil Injector	4
R90658	Gasket, Exhaust Manifold	4
R87627	O-Ring, Valve Stem	8
R81275	Gasket, Air Inlet	1
R60746	Seal, Pencil Injector	4
T20219	Gasket, Thermostat Housing	1
PM-771	Bag, 6X8 Plain, Sharp	1
NT20215	Gasket, Thermostat Cover	1
R125863-B	Gasket, Cyl Head, 4 Cyl,	1
**Oil Pan Set QRP341 Contains		
R74354	O-Ring	1
R75892	O-Ring, Oil Supply Tube	1
R77052	O-Ring	2
R79563	Sleeve, Rubber	1
R97342	Gasket, Oil Pan, 4 Cyl,	1

***Conversion Set QRP682 Contains		
A4730R	O-Ring, Oil Pump Intake	1
R116025	Gasket, Water Pump Mount	1
R495R	O-Ring, Ventilator Tube	1
R52811	O-Ring, Inlet, Outlet	1
R56192	O-Ring, Oil Cooler, Inner	1
R56193	O-Ring, Oil Cooler, Outer	1
R56461	O-Ring, Thermostat/Water Tube	1
R56814	O-Ring, Oil Cooler to Housing	1
R56815	O-Ring, Oil Cooler to Cooler	1
R61871	O-Ring	1
R70956	Packing, Oil Cooler	1
R74354	O-Ring	1
R75892	O-Ring, Oil Supply Tube	1
R77052	O-Ring	2
R79551	Gasket, Oil Cooler Cover	1
R90648	Gasket, Block to End Plate	1
R97346	Gasket, Water Line	1
R97350	Gasket, Fuel Transfer Pump	1
R97351	Gasket, Flywheel Housing	1
R97352	Gasket, Oil Filler Inlet	1
R97454	Gasket, Timing Gear Cover	1
R97773	Gasket, Cover	1
R98484	Gasket, Oil Cooler	1

R98485	Gasket, Oil Cooler, Lower	1
R98485	Gasket, Oil Cooler, Lower	1
R98486	Gasket, Oil Cooler	2
R98487	Gasket, Oil Cooler, Lower	1
R98488	Gasket, Oil Filter Adapter	1
R98489	Gasket, Oil Cooler to Cyl	1
R98834	Gasket, Oil Cooler to Cyl	1
T13213	Washer, Oil Drain Plug	1
T20273	Gasket, Timing Gear Cover	1
T20328	Gasket, Oil Filler Cap	1
T23132	Gasket, Water Inlet	1
U13639	O-Ring, Coolant Heater Plug	1

Rod Bolts

Part No.	Description	Qty.	Note
QR74194	Rod Bolt	12	For Con Rods Marked: R51727, R58979 (54mm Long)
QR80033	Rod Bolt Long	12	For Con Rods Marked: R80032, R80034, R113612 (59mm Long)

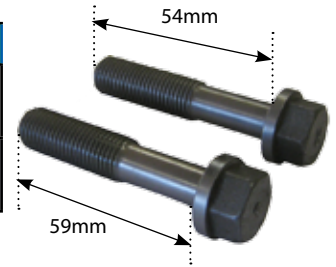

Gaskets

Gaskets			
	Part No.	Description	Qty.
1	QRE38851*	Head Set	1
2	QRP341**	Oil Pan Set	1
3	QRP682***	Conversion Set	1

59242
Sump Set

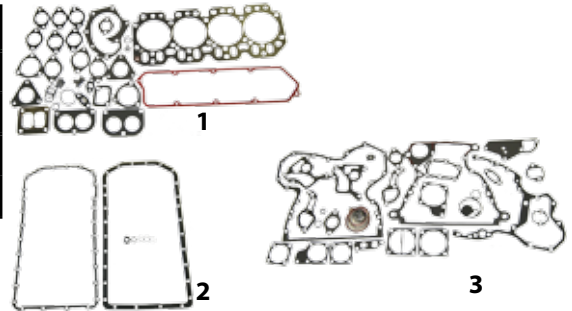

Valve Kit

Valve Kit 59237 Contains			
	Part No.	Description	Qty.
1	QR79623	Valve, Intake	4
2	QR79624	Valve, Exhaust	4
3	QR51734	Valve Seat, Exhaust	4
4	QRP223	Valve Seat, Intake	4
5	QR41412	Retainer, Valve Spring, Intake & Exhaust	8
6	QRE11410	Rotator, Intake & Exhaust	8
7	QR26125	Spring, Valve, Intake & Exhaust	8
8	QT20077	Lock, Valve, Intake & Exhaust	16
9	QT20129	Cap, Valve Stem	8
10	QR87627	O-Ring, Valve Stem	8



Ring Sets, Con Rods & Balancer Shafts

	Part No.	Description
1	QRE66820	Ring Sets
2	QRE21076	Con Rod
3	QAR61351	Balancer Shaft Right
4	QAR61352	Balancer Shaft Left

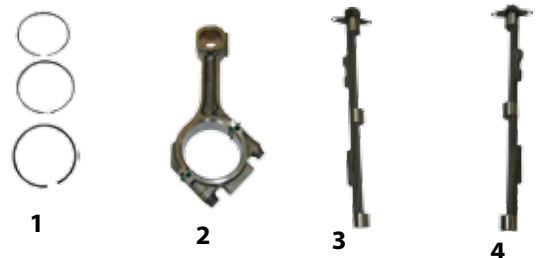

Camshaft, Tappet & Oil Cooler

	Part No.	Description
1	QR82820	Camshaft
2	QT20073	Tappet (8)
3	QRE31929	Oil Cooler



4-239T Turbo Engine

300 Series 239 inches 4 Cylinders

Engine Overhaul Kits

	Part No.	Description	91500 Standard	91510 .010"	91520 .020"
1	QRE33115	Cylinder Kit	4	4	4
1A	QAR65507	O Ring Kit	4	4	4
2	QRE501579	Gasket Set* Contains: Head Set QRE38851 Oil Pan Set QRP341 Conversion Set QRP682	1	1	1
3	QAR67942	Seal Front	1	1	1
4	QR78598	Thrust Washer for Flange-less Bearing	4	4	4
5	QR57160	Balance Bush	6	6	6
6	QR57451	Rod Bush	4	4	4
7	QRE44574	Seal Rear	1	1	1
8	QAR81786	Thrust Bearing STD	1		
	QAR81788	Thrust Bearing 10 Thou		1	
	QAR81789	Thrust Bearing 20 Thou			1
9	QRE27348	Rod Bearing STD	4		
	QRE27349	Rod Bearing 10 Thou		1	
	QRE27358	Rod Bearing 20 Thou			1
10	QRE27352	Main Bearing STD	4		
	QRE27353	Main Bearing 10 Thou		1	
	QRE27360	Main Bearing 20 Thou			1

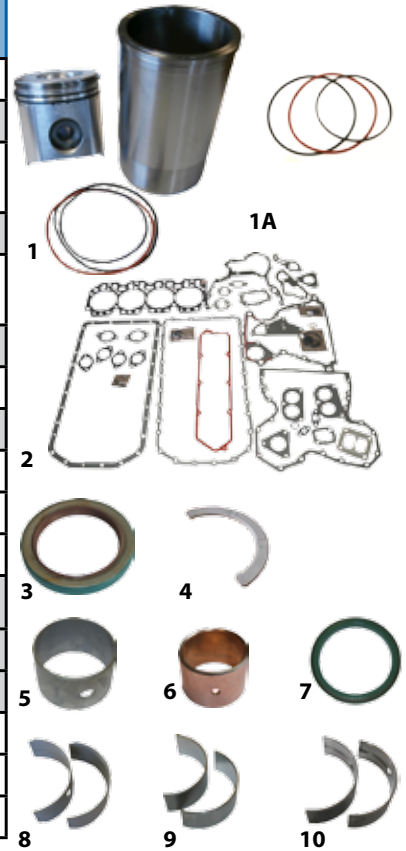

*Gasket Set

Head Set QRE38851 Contains			Conversion Set QRP682 Contains					
R73521-B	Gasket, Rocker Cover, 4 Cyl	1	A4730R	O-Ring, Oil Pump Intake	1	R98485	Gasket, Oil Cooler, Lower	1
R97354-B	Gasket, Inj Pump Mount	1	R116025	Gasket, Water Pump Mount	1	R98486	Gasket, Oil Cooler	2
R105346-B	Gasket, Turbo Oil Outlet	1	R495R	O-Ring, Ventilator Tube	1	R98487	Gasket, Oil Cooler, Lower	1
R97348-B	Gasket, Turbo Oil Inlet	1	R52811	O-Ring, Inlet, Outlet	1	R98488	Gasket, Oil Filter Adapter	1
R89879-B	Gasket, Turbo Mount	1	R56192	O-Ring, Oil Cooler, Inner	1	R98489	Gasket, Oil Cooler to Cyl	1
R56463-B	O-Ring, Vent Tube Outlet	1	R56193	O-Ring, Oil Cooler, Outer	1	R98834	Gasket, Oil Cooler to Cyl	1
R54641-B	Gasket, Thermostat to Cyl Head	1	R56461	O-Ring, Thermostat/Water Tube	1	T13213	Washer, Oil Drain Plug	1
R54638-B	Gasket, Thermostat Cover, Dual	1	R56814	O-Ring, Oil Cooler to Housing	1	T20273	Gasket, Timing Gear Cover	1
R48000	Seal, Pencil Injector	4	R56815	O-Ring, Oil Cooler to Cooler	1	T20328	Gasket, Oil Filler Cap	1
R90658	Gasket, Exhaust Manifold	4	R61871	O-Ring	1	T23132	Gasket, Water Inlet	1
R87627	O-Ring, Valve Stem	8	R70956	Packing, Oil Cooler	1	U13639	O-Ring, Coolant Heater Plug	1
R81275	Gasket, Air Inlet	1	R74354	O-Ring	1			
R60746	Seal, Pencil Injector	4	R75892	O-Ring, Oil Supply Tube	1			
T20219	Gasket, Thermostat Housing	1	R77052	O-Ring	2			
PM-771	Bag, 6X8 Plain, Sharp	1	R79551	Gasket, Oil Cooler Cover	1			
NT20215	Gasket, Thermostat Cover	1	R90648	Gasket, Block to End Plate	1			
R125863-B	Gasket, Cyl Head, 4 Cyl,	1	R97346	Gasket, Water Line	1			
Oil Pan Set QRP341 Contains			R97350	Gasket, Fuel Transfer Pump	1			
R74354	O-Ring	1	R97351	Gasket, Flywheel Housing	1			
R75892	O-Ring, Oil Supply Tube	1	R97352	Gasket, Oil Filler Inlet	1			
R77052	O-Ring	2	R97454	Gasket, Timing Gear Cover	1			
R79563	Sleeve, Rubber	1	R97773	Gasket, Cover	1			
R97342	Gasket, Oil Pan, 4 Cyl,	1	R98484	Gasket, Oil Cooler	1			

Rod Bolts

Part No.	Description	Qty.	Note
QR74194	Rod Bolt	12	For Con Rods Marked: R51727, R58979 (54mm Long)
QR80033	Rod Bolt Long	12	For Con Rods Marked: R80032, R80034, R113612 (59mm Long)

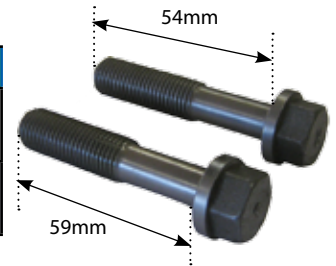

Gaskets

	Part No.	Description	Qty.
1	QRE38851	Head Set	1
2	QRP341	Oil Pan Set	1
3	QRP682	Conversion Set	1
4	QRP341+ QRP682	Sump Set	1

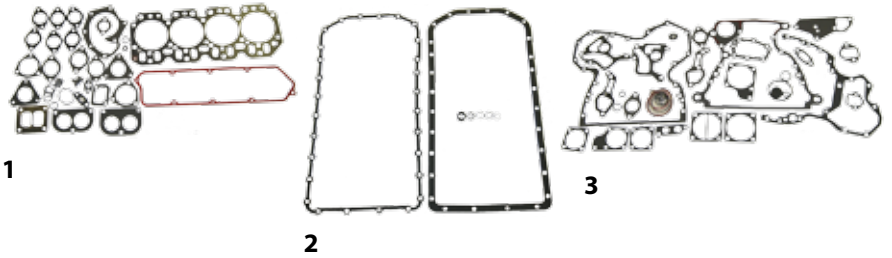

Valve Kit

Valve Kit 59239 Contains			
	Part No.	Description	Qty.
1	QR83071	Valve, Intake	4
2	QR79624	Valve, Exhaust	4
3	QR51734	Valve Seal, Exhaust	4
4	QR73064	Valve Seal, Intake	4
5	QR41412	Retainer, Valve Spring, Intake & Exhaust	8
6	QRE11410	Rotator, Intake & Exhaust	8
7	QR26125	Spring, Valve, Intake & Exhaust	8
8	QT20077	Lock, Valve, Intake & Exhaust	16
9	QT20129	Cap, Valve Stem	8
10	QR87627	O-Ring, Valve Stem	8



Ring Sets, Con Rods & Balancer Shafts

	Part No.	Description
1	QRE66820	Ring Sets
2	QRE42733	Con Rod
3	QAR69710	Balancer Shaft Right (746, 398 ->)
4	QAR69711	Balancer Shaft Left (746, 398 ->)
5	QAR61351	Balancer Shaft Right (->746, 397)
6	QAR61352	Balancer Shaft Left (->746, 397)

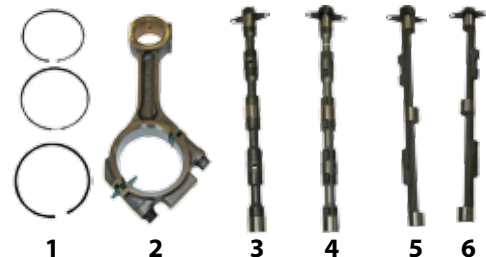

Camshaft, Tappet & Oil Cooler

	Part No.	Description
1	QR82820	Camshaft
2	QT20073	Tappet (8)
3	QRE31929	Oil Cooler



6-359D Engine

300 Series 359 inches 6 Cylinders

Engine Overhaul Kits

	Part No.	Description	93000 Standard Overhaul Kit	93010 .010" Kit	93020 .020" Kit	Bore
1	QRE30250	Cylinder Kit	6	6	6	106.5
1A	QAR65507	O Ring Kit	6	6	6	
2	QRE501580	Gasket Set	1	1	1	
3	QAR67942	Seal Front	1	1	1	
4	QR78598	Thrust Washer for Flange-less Bearing	4	4	4	
5	QR119874	Cam Bush	1	1	1	
6	QR55647	Rod Bush	6	6	6	
7	QRE44574	Seal Rear	1	1	1	
8	QAR81786	Thrust Bearing STD	1			
9	QRE27348	Rod Bearing STD	6			
10	QRE27352	Main Bearing STD	6			
11	QAR81788	Thrust Bearing 10 Thou		1		
12	QRE27349	Rod Bearing 10 Thou		6		
13	QRE27353	Main Bearing 10 Thou		4		
14	QAR81789	Thrust Bearing 20 Thou			1	
15	QRE27358	Rod Bearing 20 Thou			6	
16	QRE27360	Main Bearing 20 Thou			4	

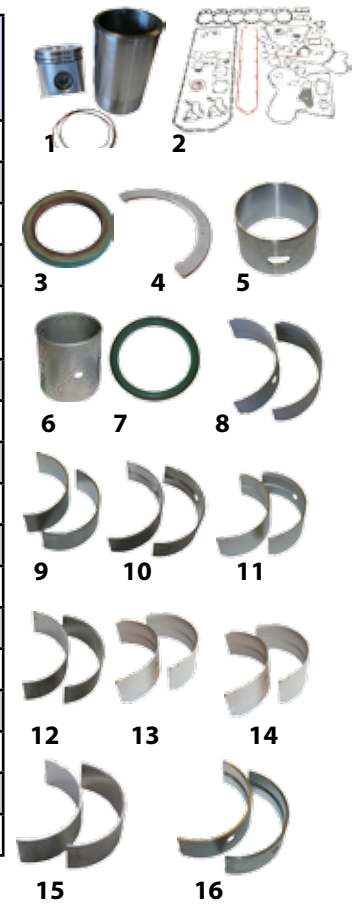

*Head Set QRE38852 Contains		
R114157-B	Gasket, Cyl Head, 6 Cyl,	1
R75728-B	Gasket, Rocker Cover, 6 Cyl	1
T24932	Gasket, Thermostat Cover	1
T23002	Gasket, Water Manifold Outlet	3
R60746	Seal, Pencil Injector	6
R56905	O-Ring, Air Intake	1
R81275	Gasket, Air Inlet	2
R87627	O-Ring, Valve Stem	12
R90658	Gasket, Exhaust Manifold	6
R48000	Seal, Pencil Injector	6
R97354-B	Gasket, Inj Pump Mount	1
R105346-B	Gasket, Turbo Oil Outlet	1
R97348-B	Gasket, Turbo Oil Inlet	1
R89879-B	Gasket, Turbo Mount	1
R56463-B	O-Ring, Vent Tube Outlet	1
R54641-B	Gasket, Thermostat to Cyl Head	1
R54638-B	Gasket, Thermostat Cover, Dual	

**Conversion Set QRP682 Contains					
A4730R	O-Ring, Oil Pump Intake	1	R98485	Gasket, Oil Cooler, Lower	1
R116025	Gasket, Water Pump Mount	1	R98485	Gasket, Oil Cooler, Lower	1
R495R	O-Ring, Ventilator Tube	1	R98486	Gasket, Oil Cooler	2
R52811	O-Ring, Inlet, Outlet	1	R98487	Gasket, Oil Cooler, Lower	1
R56192	O-Ring, Oil Cooler, Inner	1	R98488	Gasket, Oil Filter Adapter	1
R56193	O-Ring, Oil Cooler, Outer	1	R98489	Gasket, Oil Cooler to Cyl	1
R56461	O-Ring, Thermostat/Water Tube	1	R98834	Gasket, Oil Cooler to Cyl	1
R56814	O-Ring, Oil Cooler to Housing	1	T13213	Washer, Oil Drain Plug	1
R56815	O-Ring, Oil Cooler to Cooler	1	T20273	Gasket, Timing Gear Cover	1
R61871	O-Ring	1	T20328	Gasket, Oil Filler Cap	1
R70956	Packing, Oil Cooler	1	T23132	Gasket, Water Inlet	1
R74354	O-Ring	1	U13639	O-Ring, Coolant Heater Plug	1
R75892	O-Ring, Oil Supply Tube	1			
R77052	O-Ring	2			
R79551	Gasket, Oil Cooler Cover	1			
R90648	Gasket, Block to End Plate	1			
R97346	Gasket, Water Line	1			
R97350	Gasket, Fuel Transfer Pump	1			
R97351	Gasket, Flywheel Housing	1			
R97352	Gasket, Oil Filler Inlet	1			
R97454	Gasket, Timing Gear Cover	1			
R97773	Gasket, Cover	1			
R98484	Gasket, Oil Cooler	1			

Oil Pan Set QRP343

Rod Bolts

Part No.	Description	Qty.	Note
QR74194	Rod Bolt	12	For Con Rods Marked: R51727, R58979 (54mm Long)
QR80033	Rod Bolt Long	12	For Con Rods Marked: R80032, R80034, R113612 (59mm Long)

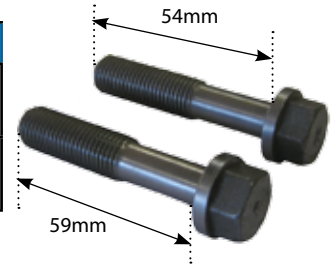

Gaskets

Gaskets			
	Part No.	Description	Qty.
1	QRE38852*	Head Set	1
2	QRP343	Oil Pan Set	1
3	QRP682**	Conversion Set	1

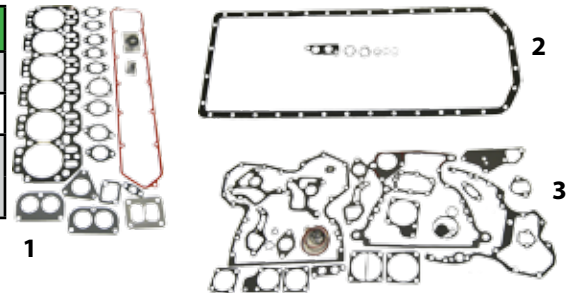

Valve Kit

Valve Kit 59236 Contains			
	Part No.	Description	Qty.
1	QR79623	Valve, Intake	6
2	QR79624	Valve, Exhaust	6
3	QR51734	Valve Seat, Exhaust	6
4	QRP223	Valve Seat, Intake	6
5	QR41412	Retainer, Valve Spring, Intake & Exhaust	12
6	QRE11410	Rotator, Intake & Exhaust	12
7	QR26125	Spring, Valve, Intake & Exhaust	12
8	QT20077	Lock, Valve, Intake & Exhaust	24
9	QT20129	Cap, Valve Stem	12
10	QR87627	O-Ring, Valve Stem	12



Ring Sets, Con Rod

	Part No.	Description
1	QRE66820	Ring Sets
2	QRE21076	Con Rod



Camshaft, Tappet & Oil Cooler

	Part No.	Description
1	QR82821	Camshaft
2	QT20073	Tappet (12)
3	QRE31929	Oil Cooler

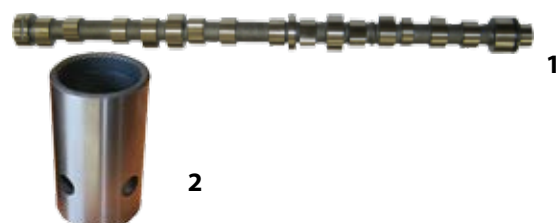

6359T Turbo Engine

300 Series 359 inches 6 Cylinders

Engine Overhaul Kits

	Part No.	Description	91000 Standard Overhaul Kit	91010 .010" Kit	91020 .020" Kit	Bore
1	QRE33115	Cylinder Kit	6	6	6	106.5
1A	QAR65507	O Ring Kit	6	6	6	
2	QRE501580	Gasket Set	1	1	1	
3	QAR67942	Seal Front	1	1	1	
4	QR78598	Thrust Washer for Flange-less Bearing	4	4	4	
5	QR57451	Rod Bush	6	6	6	
6	QRE44574	Seal Rear	1	1	1	
7	QAR81786	Thrust Bearing STD	1			
8	QRE27348	Rod Bearing STD	6			
9	QRE27352	Main Bearing STD	6			
10	QAR81788	Thrust Bearing 10 Thou		1		
11	QRE27349	Rod Bearing 10 Thou		6		
12	QRE27353	Main Bearing 10 Thou		6		
13	QAR81789	Thrust Bearing 20 Thou			1	
14	QRE27358	Rod Bearing 20 Thou			6	
15	QRE27360	Main Bearing 20 Thou			6	

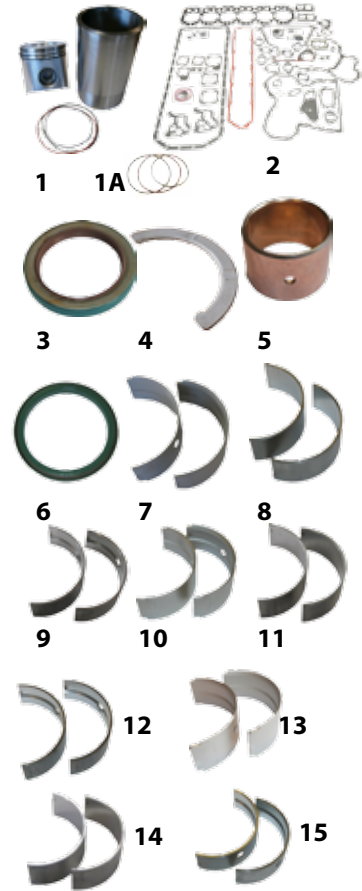

*Head Set QRE38852 Contains			**Conversion Set QRP682 Contains					
R114157-B	Gasket, Cyl Head, 6 Cyl,	1	A4730R	O-Ring, Oil Pump Intake	1	R98485	Gasket, Oil Cooler, Lower	1
R75728-B	Gasket, Rocker Cover, 6 Cyl	1	R116025	Gasket, Water Pump Mount	1	R98485	Gasket, Oil Cooler, Lower	1
T24932	Gasket, Thermostat Cover	1	R495R	O-Ring, Ventilator Tube	1	R98486	Gasket, Oil Cooler	2
T23002	Gasket, Water Manifold Outlet	3	R52811	O-Ring, Inlet, Outlet	1	R98487	Gasket, Oil Cooler, Lower	1
R60746	Seal, Pencil Injector	6	R56192	O-Ring, Oil Cooler, Inner	1	R98488	Gasket, Oil Filter Adapter	1
R56905	O-Ring, Air Intake	1	R56193	O-Ring, Oil Cooler, Outer	1	R98489	Gasket, Oil Cooler to Cyl	1
R81275	Gasket, Air Inlet	2	R56461	O-Ring, Thermostat/Water Tube	1	R98834	Gasket, Oil Cooler to Cyl	1
R87627	O-Ring, Valve Stem	12	R56814	O-Ring, Oil Cooler to Housing	1	T13213	Washer, Oil Drain Plug	1
R90658	Gasket, Exhaust Manifold	6	R56815	O-Ring, Oil Cooler to Cooler	1	T20273	Gasket, Timing Gear Cover	1
R48000	Seal, Pencil Injector	6	R61871	O-Ring	1	T20328	Gasket, Oil Filler Cap	1
R97354-B	Gasket, Inj Pump Mount	1	R70956	Packing, Oil Cooler	1	T23132	Gasket, Water Inlet	1
R105346-B	Gasket, Turbo Oil Outlet	1	R74354	O-Ring	1	U13639	O-Ring, Coolant Heater Plug	1
R97348-B	Gasket, Turbo Oil Inlet	1	R75892	O-Ring, Oil Supply Tube	1			
R89879-B	Gasket, Turbo Mount	1	R77052	O-Ring	2			
R56463-B	O-Ring, Vent Tube Outlet	1	R79551	Gasket, Oil Cooler Cover	1			
R54641-B	Gasket, Thermostat to Cyl Head	1	R90648	Gasket, Block to End Plate	1			
R54638-B	Gasket, Thermostat Cover, Dual		R97346	Gasket, Water Line	1			
			R97350	Gasket, Fuel Transfer Pump	1			
			R97351	Gasket, Flywheel Housing	1			
			R97352	Gasket, Oil Filler Inlet	1			
			R97454	Gasket, Timing Gear Cover	1			
			R97773	Gasket, Cover	1			
			R98484	Gasket, Oil Cooler	1			

Oil Pan Set QRP343

Rod Bolts

Part No.	Description	Qty.	Note
QR74194	Rod Bolt	12	For Con Rods Marked: R51727, R58979 (54mm Long)
QR80033	Rod Bolt Long	12	For Con Rods Marked: R80032, R80034, R113612 (59mm Long)

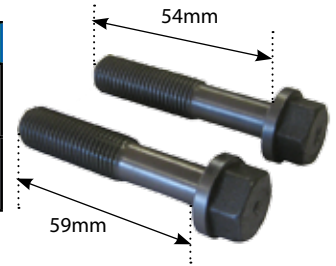

Gaskets

Gaskets			
	Part No.	Description	Qty.
1	QRE38852	Head Set*	1
2	QRP343	Oil Pan Set	1
3	QRP682	Conversion Set**	1
			} Sump Set

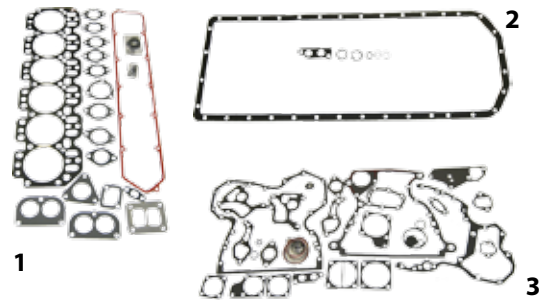

Valve Kit

Valve Kit 59238 Contains			
	Part No.	Description	Qty.
1	QR83071	Valve, Intake	6
2	QR79624	Valve, Exhaust	6
3	QR51734	Valve Seat, Exhaust	6
4	QR73064	Valve Seat, Intake	6
5	QR41412	Retainer, Valve Spring, Intake & Exhaust	12
6	QRE11410	Rotator, Intake & Exhaust	12
7	QR26125	Spring, Valve, Intake & Exhaust	12
8	QT20077	Lock, Valve, Intake & Exhaust	24
9	QT20129	Cap, Valve Stem	12
10	QR87627	O-Ring, Valve Stem	12



Ring Sets, Con Rods

	Part No.	Description
1	QRE66820	Ring Sets
2	QRE42733	Con Rod



Camshaft, Tappet & Oil Cooler

	Part No.	Description
1	QR82821	Camshaft
2	QT20073	Tappet (12)
3	QRE31929	Oil Cooler



4039T Turbo Engine

300 Series 3.9 Litres 4 Cylinders

Engine Overhaul Kits

	Part No.	Description	90000 Standard	90010 .010"	90020 .020"
1	QRE33115	Cylinder Kit	4	4	4
1A	QAR65507	O Ring Kit	4	4	4
2	QRE501579	Gasket Set	1	1	1
3	QAR67942	Seal Front	1	1	1
4	QR78598	Thrust Washer for Flange-less Bearing	4	4	4
5	QR57160	Balance Bush	6	6	6
6	QR119874	Cam Bush	1	1	1
7	QR57451	Rod Bush	4	4	4
8	QRE44574	Seal Rear	1	1	1
9	QAR81786	Thrust Bearing STD	1		
10	QRE27348	Rod Bearing STD	4		
11	QRE27352	Main Bearing STD	4		
12	QAR81788	Thrust Bearing 10 Thou		1	
13	QRE27349	Rod Bearing 10 Thou		4	
14	QRE27353	Main Bearing 10 Thou		4	
15	QAR81789	Thrust Bearing 20 Thou			1
16	QRE27358	Rod Bearing 20 Thou			4
17	QRE27360	Main Bearing 20 Thou			4



* Head Set QRE38851 Contains		
R73521-B	Gasket, Rocker Cover, 4 Cyl	1
R97354-B	Gasket, Inj Pump Mount	1
R105346-B	Gasket, Turbo Oil Outlet	1
R97348-B	Gasket, Turbo Oil Inlet	1
R89879-B	Gasket, Turbo Mount	1
R56463-B	O-Ring, Vent Tube Outlet	1
R54641-B	Gasket, Thermostat to Cyl Head	1
R54638-B	Gasket, Thermostat Cover, Dual	1
R48000	Seal, Pencil Injector	4
R90658	Gasket, Exhaust Manifold	4
R87627	O-Ring, Valve Stem	8
R81275	Gasket, Air Inlet	1
R60746	Seal, Pencil Injector	4
T20219	Gasket, Thermostat Housing	1
PM-771	Bag, 6X8 Plain, Sharp	1
NT20215	Gasket, Thermostat Cover	1
R125863-B	Gasket, Cyl Head, 4 Cyl,	1
**Oil Pan Set QRP341 Contains		
R74354	O-Ring	1
R75892	O-Ring, Oil Supply Tube	1
R77052	O-Ring	2
R79563	Sleeve, Rubber	1
R97342	Gasket, Oil Pan, 4 Cyl,	1

*** Conversion Set QRP682 Contains					
A4730R	O-Ring, Oil Pump Intake	1	R98485	Gasket, Oil Cooler, Lower	1
R116025	Gasket, Water Pump Mount	1	R98485	Gasket, Oil Cooler, Lower	1
R495R	O-Ring, Ventilator Tube	1	R98486	Gasket, Oil Cooler	2
R52811	O-Ring, Inlet, Outlet	1	R98487	Gasket, Oil Cooler, Lower	1
R56192	O-Ring, Oil Cooler, Inner	1	R98488	Gasket, Oil Filter Adapter	1
R56193	O-Ring, Oil Cooler, Outer	1	R98489	Gasket, Oil Cooler to Cyl	1
R56461	O-Ring, Thermostat/Water Tube	1	R98834	Gasket, Oil Cooler to Cyl	1
R56814	O-Ring, Oil Cooler to Housing	1	T13213	Washer, Oil Drain Plug	1
R56815	O-Ring, Oil Cooler to Cooler	1	T20273	Gasket, Timing Gear Cover	1
R61871	O-Ring	1	T20328	Gasket, Oil Filler Cap	1
R70956	Packing, Oil Cooler	1	T23132	Gasket, Water Inlet	1
R74354	O-Ring	1	U13639	O-Ring, Coolant Heater Plug	1
R75892	O-Ring, Oil Supply Tube	1			
R77052	O-Ring	2			
R79551	Gasket, Oil Cooler Cover	1			
R90648	Gasket, Block to End Plate	1			
R97346	Gasket, Water Line	1			
R97350	Gasket, Fuel Transfer Pump	1			
R97351	Gasket, Flywheel Housing	1			
R97352	Gasket, Oil Filler Inlet	1			
R97454	Gasket, Timing Gear Cover	1			
R97773	Gasket, Cover	1			
R98484	Gasket, Oil Cooler	1			

Rod Bolts

Part No.	Description	Qty.	Note
QR80033	Rod Bolt Long	8	For Con Rods Marked: R80032, R80034, R113612 (59mm Long)



Gaskets

Gaskets			
	Part No.	Description	Qty.
1	QRE38851	Head Set*	1
2	QRP341	Oil Pan Set**	1
3	QRP682	Conversion Set***	1

59242
Sump Set

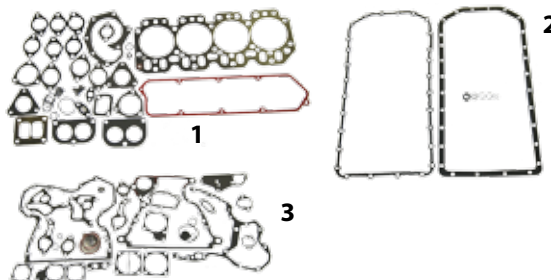

Valve Kit

Valve Kit 59240 Contains			
	Part No.	Description	Qty.
1	QR98062	Valve, Intake	4
2	QR90692	Valve, Exhaust	4
3	QR85687	Valve Seat, Exhaust	4
4	QR98063	Valve Seat, Intake	4
5	QRE60005	Rotator, Intake & Exhaust	8
6	QR26125	Spring, Valve, Intake & Exhaust	8
7	QR91889	Lock, Valve, Intake & Exhaust	16
8	QRE31617	Cap, Valve Stem	8



Ring Sets, Con Rods & Balancer Shafts

	Part No.	Description
1	QRE66820	Ring Sets
2	QRE42733	Con Rod

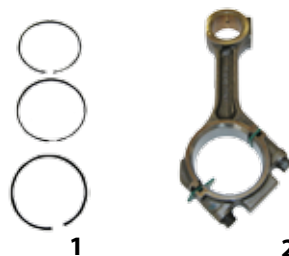

Camshaft, Tappet & Oil Cooler

	Part No.	Description
1	QR82820	Camshaft
2	QT20073	Tappet (8)
3	QRE31929	Oil Cooler



4045T Turbo Engine

300 Series 4.5 Litres 4 Cylinders

Engine Overhaul Kits

	Part No.	Description	94000 Standard Overhaul Kit	94010 .010" Kit	94020 .020" Kit
1	QRE53073	Cylinder Kit Bore=106.5	4	4	4
1A	QAR65507	O Ring Kit	4	4	4
2	QRE501568	Gasket Set*	1	1	1
3	QAR67942	Seal Front	1	1	1
4	QR78598	Thrust Washer for Flange-less Bearing	4	4	4
5	QR57160	Balance Bush	6	6	6
6	QR57451	Rod Bush	4	4	4
7	QRE44574	Seal Rear	1	1	1
8	QAR81786	Thrust Bearing STD	1		
9	QAR97517	Rod Bearing STD	4		
10	QRE27352	Main Bearing STD	4		
11	QAR81788	Thrust Bearing 10 Thou		1	
12	QAR97653	Rod Bearing 10 Thou		4	
13	QRE27353	Main Bearing 10 Thou		4	
14	QAR81789	Thrust Bearing 20 Thou			1
15	QAR97654	Rod Bearing 20 Thou			4
16	QRE27360	Main Bearing 20 Thou			4



*Gasket Set

Head Set QRE501568 Contains		
R97354-B	Gasket, Inj Pump Mount	1.
R105346-B	Gasket, Turbo Oil Outlet	1.
R97348-B	Gasket, Turbo Oil Inlet	1.
R89879-B	Gasket, Turbo Mount	1.
R56463-B	O-Ring, Vent Tube Outlet	1.
R54641-B	Gasket, Thermostat to Cyl Head	1.
R54638-B	Gasket, Thermostat Cover, Dual	1.
R79551-B	Gasket, Oil Cooler Cover	1.
R77052-B	O-Ring	2.
R61871-B	O-Ring	1.
R56815-B	O-Ring, Oil Cooler to Cooler	1.
R56814-B	O-Ring, Oil Cooler to Housing	1.
R56193-B	O-Ring, Oil Cooler, Outer	1.
R56192-B	O-Ring, Oil Cooler, Inner	1.
U13639-B	O-Ring, Coolant Heater Plug	1.
R98834-B	Gasket, Oil Cooler to Cyl	1.
R98489-B	Gasket, Oil Cooler to Cyl	1.
R98488-B	Gasket, Oil Filter Adapter	1.
R98487-B	Gasket, Oil Cooler, Lower	1.
R98486-B	Gasket, Oil Cooler	2.
R98485-B	Gasket, Oil Cooler, Lower	1.
R98484-B	Gasket, Oil Cooler	1.

A4730R-B	O-Ring, Oil Pump Intake	1.
R48000	Seal, Pencil Injector	4.
R90658	Gasket, Exhaust Manifold	4.
R87627	O-Ring, Valve Stem	8.
R81275	Gasket, Air Inlet	1.
R60746	Seal, Pencil Injector	4.
T20219	Gasket, Thermostat Housing	1.
T20215	Gasket, Thermostat Cover	1.
R56461	O-Ring, Thermostat/Water Tube	1.
R97773	Gasket, Cover	1.
T20328	Gasket, Oil Filler Cap	1.
T20273	Gasket, Timing Gear Cover	1.
R97454	Gasket, Timing Gear Cover	1.
NT13213	Washer, Oil Drain Plug	1.
R97351	Gasket, Flywheel Housing	1.
R90648	Gasket, Block to End Plate	1.
R116025	Gasket, Water Pump Mount	1.
R70956	Packing, Oil Cooler	1.
R74354	O-Ring	1.
R75892	O-Ring, Oil Supply Tube	1.
R97350	Gasket, Fuel Transfer Pump	1.
R97352	Gasket, Oil Filler Inlet	1.
R73521-B	Gasket, Rocker Cover, 4 Cyl	1.

R97342-B	Gasket, Oil Pan, 4 Cyl,	1.
R79563-B	Sleeve, Rubber	1.
R77052-B	O-Ring	2.
R75892-B	O-Ring, Oil Supply Tube	1.
R74354-B	O-Ring	1.
R132256	Gasket, Oil Filler Housing	1.
R26286	O-Ring, Fuel Line	1.
R79563	Sleeve, Rubber	1.
R61871	O-Ring	1.
R56461	O-Ring, Thermostat/Water Tube	1.
T20304	O-Ring	1.
R125863-B	Gasket, Cyl Head, 4 Cyl,	1.

Rod Bolts

Part No.	Description	Qty.
QR74195	Rod Bolt 4045T 6068T 300 Series (64mm Long)	8



Gaskets

Gaskets			
	Part No.	Description	Qty.
1	QRE38851	Head Set	1
2	QRP341	Oil Pan Set	1

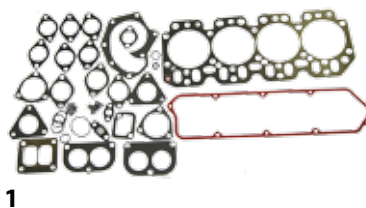

1



2

Valve Kit

Valve Kit 59236 Contains			
	Part No.	Description	Qty.
1	QR98062	Valve, Intake	4
2	QR90692	Valve, Exhaust	4
3	QR85687	Valve Seat, Exhaust	4
4	QR98063	Valve Seat, Intake	4
5	QRE60005	Rotator, Intake & Exhaust	8
6	QR26125	Spring, Valve, Intake & Exhaust	8
7	QR91889	Lock, Valve, Intake & Exhaust	16
8	QRE31617	Cap, Valve Stem	8



Ring Sets, Con Rod

Part No.	Description
1	QRE66820 Ring Sets
2	QAR69710 Balancer Shaft Right
3	QAR69711 Balancer Shaft Left



Camshaft, Tappet

Part No.	Description
1	QR82820 Camshaft
2	QT20073 Tappet (8)



6059D Engine Type

300 Series 5.9 Litres 6 Cylinders



RELIANCE

	Part No.	Description	10000 Standard Overhaul Kit	10010 .010" Kit	10020 .020" Kit	Bore
1	QRE30250	Cylinder Kit	6	6	6	106.5
1A	QAR65507	O Ring Kit	6	6	6	
2	QRE501580	Gasket Set*	1	1	1	
3	QAR67942	Seal Front	1	1	1	
4	QAR81786	Thrust Bearing Pair	1			
5	QAR81786	Thrust Bearing 10 Thou		1		
6	QAR81789	Thrust Bearing 20 Thou			1	
7	QR78598	Thrust Washer for Flangeless Bearing	4	4	4	
8	QR55647	Rod Bush	6	6	6	
9	QR80033	Rod Bolt LONG	12	12	12	
10	QRE44574	Seal Rear	1	1	1	
11	QRE27348	Rod Bearing STD	6			
12	QRE27349	Rod Bearing 10 Thou		6		
13	QRE27358	Rod Bearing 20 Thou			6	
14	QRE27352	Main Bearing STD	6			
15	QRE27353	Main Bearing 10 Thou		6		
16	QRE27360	Main Bearing 20 Thou			6	



*Gasket Set

Head Set QRE501580 Contains		
R114157-B	Gasket, Cyl Head, 6 Cyl,	1
T24932	Gasket, Thermostat Cover	1
NT23002	Gasket, Water Manifold Outlet	3
R60746	Seal, Pencil Injector	6
R56905	O-Ring, Air Intake	1
R81275	Gasket, Air Inlet	2
R87627	O-Ring, Valve Stem	12
R90658	Gasket, Exhaust Manifold	6
NR48000	Seal, Pencil Injector	6
R97354-B	Gasket, Inj Pump Mount	1
R105346-B	Gasket, Turbo Oil Outlet	1
R97348-B	Gasket, Turbo Oil Inlet	1
R89879-B	Gasket, Turbo Mount	1
R56463-B	O-Ring, Vent Tube Outlet	1
R54641-B	Gasket, Thermostat to Cyl Head	1
R54638-B	Gasket, Thermostat Cover, Dual	1
R56461	O-Ring, Thermostat/Water Tube	1
R97773	Gasket, Cover	1
T20328	Gasket, Oil Filler Cap	1
T20273	Gasket, Timing Gear Cover	1
R97454	Gasket, Timing Gear Cover	1
T13213	Washer, Oil Drain Plug	1
R97351	Gasket, Flywheel Housing	1

R90648	Gasket, Block to End Plate	1
R116025	Gasket, Water Pump Mount	1
R70956	Packing, Oil Cooler	1
R74354	O-Ring	1
R75892	O-Ring, Oil Supply Tube	1
R97350	Gasket, Fuel Transfer Pump	1
R97352	Gasket, Oil Filler Inlet	1
R75728-B	Gasket, Rocker Cover, 6 Cyl	1
R79551-B	Gasket, Oil Cooler Cover	1
R77052-B	O-Ring	2
R61871-B	O-Ring	1
R56815-B	O-Ring, Oil Cooler to Cooler	1
R56814-B	O-Ring, Oil Cooler to Housing	1
R56193-B	O-Ring, Oil Cooler, Outer	1
R56192-B	O-Ring, Oil Cooler, Inner	1
U13639-B	O-Ring, Coolant Heater Plug	1
R98834-B	Gasket, Oil Cooler to Cyl	1
R98489-B	Gasket, Oil Cooler to Cyl	1
R98488-B	Gasket, Oil Filter Adapter	1
R98487-B	Gasket, Oil Cooler, Lower	1
R98486-B	Gasket, Oil Cooler	2
R98485-B	Gasket, Oil Cooler, Lower	1
R98484-B	Gasket, Oil Cooler	1

NR90648	Gasket, Block to End Plate	1
A4730R-B	O-Ring, Oil Pump Intake	1
R26286-B	O-Ring, Fuel Line	1
R97354-B	Gasket, Inj Pump Mount	1
R61871-B	O-Ring	1
R56461-B	O-Ring, Thermostat/Water Tube	1
T23132-B	Gasket, Water Inlet	1
R116025-B	Gasket, Water Pump Mount	1
T20304-B	O-Ring	1
R98488	Gasket, Oil Filter Adapter	1
R77052	O-Ring	2
R74354	O-Ring	1
R61871	O-Ring	2
R97344	Subs to RP343	1

6059T Engine Type

300 Series 5.9 Litres 6 Cylinders



RELIANCE

	Part No.	Description	10030 Standard Overhaul Kit	10040 .010" Kit	10050 .020" Kit	Bore
1	QRE33115	Cylinder Kit	6	6	6	106.5
1A	QAR65507	O Ring Kit	6	6	6	
2	QRE501580	Gasket Set*	1	1	1	
3	QAR67942	Seal Front	1	1	1	
4	QAR81786	Thrust Bearing Pair	1			
5	QAR81788	Thrust Bearing 10 Thou		1		
6	QAR81789	Thrust Bearing 20 Thou			1	
7	QR78598	Thrust Washer for Flangeless Bearing	4	4	4	
8	QR57451	Rod Bush	6	6	6	
9	QR80033	Rod Bolt LONG	12	12	12	
10	QRE44574	Seal Rear	1	1	1	
11	QRE27348	Rod Bearing STD	6			
12	QRE27349	Rod Bearing 10 Thou		6		
13	QRE27358	Rod Bearing 20 Thou			6	
14	QRE27352	Main Bearing STD	6			
15	QRE27353	Main Bearing 10 Thou		6		
16	QRE27360	Main Bearing 20 Thou			6	



*Gasket Set

Head Set QRE501580 Contains		
R114157-B	Gasket, Cyl Head, 6 Cyl,	1
T24932	Gasket, Thermostat Cover	1
T23002	Gasket, Water Manifold Outlet	3
R60746	Seal, Pencil Injector	6
R56905	O-Ring, Air Intake	1
R81275	Gasket, Air Inlet	2
R87627	O-Ring, Valve Stem	12
R90658	Gasket, Exhaust Manifold	6
R48000	Seal, Pencil Injector	6
R97354-B	Gasket, Inj Pump Mount	1
R105346-B	Gasket, Turbo Oil Outlet	1
R97348-B	Gasket, Turbo Oil Inlet	1
R89879-B	Gasket, Turbo Mount	1
R56463-B	O-Ring, Vent Tube Outlet	1
R54641-B	Gasket, Thermostat to Cyl Head	1
R54638-B	Gasket, Thermostat Cover, Dual	1
R56461	O-Ring, Thermostat/Water Tube	1
R97773	Gasket, Cover	1
T20328	Gasket, Oil Filler Cap	1
T20273	Gasket, Timing Gear Cover	1
R97454	Gasket, Timing Gear Cover	1

T13213	Washer, Oil Drain Plug	1
R97351	Gasket, Flywheel Housing	1
R90648	Gasket, Block to End Plate	1
R116025	Gasket, Water Pump Mount	1
R70956	Packing, Oil Cooler	1
R74354	O-Ring	1
R75892	O-Ring, Oil Supply Tube	1
R97350	Gasket, Fuel Transfer Pump	1
R97352	Gasket, Oil Filler Inlet	1
R75728-B	Gasket, Rocker Cover, 6 Cyl	1
R79551-B	Gasket, Oil Cooler Cover	1
R77052-B	O-Ring	2
R61871-B	O-Ring	1
R56815-B	O-Ring, Oil Cooler to Cooler	1
R56814-B	O-Ring, Oil Cooler to Housing	1
R56193-B	O-Ring, Oil Cooler, Outer	1
R56192-B	O-Ring, Oil Cooler, Inner	1
U13639-B	O-Ring, Coolant Heater Plug	1
R98834-B	Gasket, Oil Cooler to Cyl	1
R98489-B	Gasket, Oil Cooler to Cyl	1
R98488-B	Gasket, Oil Filter Adapter	1

R98487-B	Gasket, Oil Cooler, Lower	1
R98486-B	Gasket, Oil Cooler	2
R98485-B	Gasket, Oil Cooler, Lower	1
R98484-B	Gasket, Oil Cooler	1
R90648	Gasket, Block to End Plate	1
A4730R-B	O-Ring, Oil Pump Intake	1
R26286-B	O-Ring, Fuel Line	1
NR97354-B	Gasket, Inj Pump Mount	1
R61871-B	O-Ring	1
R56461-B	O-Ring, Thermostat/Water Tube	1
T23132-B	Gasket, Water Inlet	1
R116025-B	Gasket, Water Pump Mount	1
T20304-B	O-Ring	1
R98488	Gasket, Oil Filter Adapter	1
R77052	O-Ring	2
R74354	O-Ring	1
R61871	O-Ring	2
R97344	Subs to RP343	1

6068T Turbo Engine

300 Series 6.8 Litres 6 Cylinders

Engine Overhaul Kits

	Part No.	Description	95000 Standard Overhaul Kit	95010 .010" Kit	95020 .020" Kit
1	QRE53073	Cylinder Kit Bore 106.5	6	6	6
1A	QAR65507	O Ring Kit	6	6	6
2	QRE501569	Gasket Set*	1	1	1
3	QAR67942	Seal Front	1	1	1
4	QR78598	Thrust Washer for Flange-less Bearing	4	4	4
5	QR57451	Rod Bush	6	6	6
6	QRE44574	Seal Rear	1	1	1
7	QAR81786	Thrust Bearing STD	1		
8	QAR97517	Rod Bearing STD	6		
9	QRE27352	Main Bearing STD	6		
10	QAR81788	Thrust Bearing 10 Thou		1	
11	QAR97653	Rod Bearing 10 Thou		6	
12	QRE27353	Main Bearing 10 Thou		6	
13	QAR81789	Thrust Bearing 20 Thou			1
14	QAR97654	Rod Bearing 20 Thou			6
15	QRE27360	Main Bearing 20 Thou			6

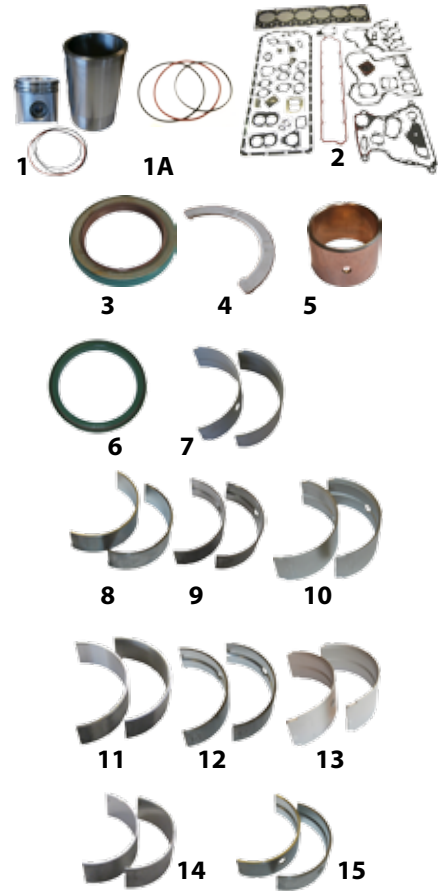

*Gasket Set

Head Set QRE501569 Contains		
R114157-B	Gasket, Cyl Head, 6 Cyl,	1.
T24932	Gasket, Thermostat Cover	1.
T23002	Gasket, Water Manifold Outlet	3.
R60746	Seal, Pencil Injector	6.
R56905	O-Ring, Air Intake	1.
R81275	Gasket, Air Inlet	2.
R87627	O-Ring, Valve Stem	12.
R90658	Gasket, Exhaust Manifold	6.
R48000	Seal, Pencil Injector	6.
R97354-B	Gasket, Inj Pump Mount	1.
R105346-B	Gasket, Turbo Oil Outlet	1.
R97348-B	Gasket, Turbo Oil Inlet	1.
R89879-B	Gasket, Turbo Mount	1.
R56463-B	O-Ring, Vent Tube Outlet	1.
R54641-B	Gasket, Thermostat to Cyl Head	1.
R54638-B	Gasket, Thermostat Cover, Dual	1.
R79551-B	Gasket, Oil Cooler Cover	1.
R77052-B	O-Ring	2.
R61871-B	O-Ring	1.
R56815-B	O-Ring, Oil Cooler to Cooler	1.
R56814-B	O-Ring, Oil Cooler to Housing	1.
R56193-B	O-Ring, Oil Cooler, Outer	1.
R56192-B	O-Ring, Oil Cooler, Inner	1.
U13639-B	O-Ring, Coolant Heater Plug	1.
R98834-B	Gasket, Oil Cooler to Cyl	1.

R98489-B	Gasket, Oil Cooler to Cyl	1.
R98488-B	Gasket, Oil Filter Adapter	1.
R98487-B	Gasket, Oil Cooler, Lower	1.
R98486-B	Gasket, Oil Cooler	2.
R98485-B	Gasket, Oil Cooler, Lower	1.
R98484-B	Gasket, Oil Cooler	1.
A4730R-B	O-Ring, Oil Pump Intake	1.
R56461	O-Ring, Thermostat/Water Tube	1.
R97773	Gasket, Cover	1.
T20328	Gasket, Oil Filler Cap	1.
T20273	Gasket, Timing Gear Cover	1.
R97454	Gasket, Timing Gear Cover	1.
T13213	Washer, Oil Drain Plug	1.
T13213-B	Washer, Oil Drain Plug	1.
R97351	Gasket, Flywheel Housing	1.
R90648	Gasket, Block to End Plate	1.
R116025	Gasket, Water Pump Mount	1.
R70956	Packing, Oil Cooler	1.
R74354	O-Ring	1.
R75892	O-Ring, Oil Supply Tube	1.
R97350	Gasket, Fuel Transfer Pump	1.
R97352	Gasket, Oil Filler Inlet	1.
R75728-B	Gasket, Rocker Cover, 6 Cyl	1.
R98488	Gasket, Oil Filter Adapter	1.
R77052	O-Ring	2.
R74354	O-Ring	1.

R61871	O-Ring	2.
R97344	Subs to RP343	1.
R97346	Gasket, Water Line	1.
R52811	O-Ring, Inlet, Outlet	2.
T23132	Gasket, Water Inlet	1.
R132256	Gasket, Oil Filler Housing	1.
R26286	O-Ring, Fuel Line	1.
R79563	Sleeve, Rubber	1.
R61871	O-Ring	1.
R56461	O-Ring, Thermostat/Water Tube	1.
T20304	O-Ring	1.

Rod Bolts

Part No.	Description	Qty.
QR74195	Rod Bolt 4045T 6068T 300 Series (64mm Long)	12



Gaskets

Gaskets			
	Part No.	Description	Qty.
1	QRE38852	Head Set	1
2	QRP343	Oil Pan Set	1
3	QRP682	Conversion Set	1

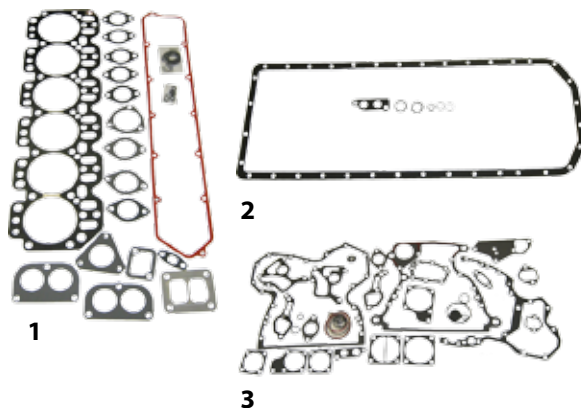

Valve Kit

Valve Kit 59235 Contains			
	Part No.	Description	Qty.
1	QR98062	Valve, Intake	6
2	QR90692	Valve, Exhaust	6
3	QR85687	Valve Seat, Exhaust	6
4	QR98063	Valve Seat, Intake	6
5	QRE60005	Rotator, Intake & Exhaust	12
6	QR26125	Spring, Valve, Intake & Exhaust	12
7	QR91889	Lock, Valve, Intake & Exhaust	24
8	QRE31617	Cap, Valve Stem	12



Ring Sets

Part No.	Description
1	QRE66820



Camshaft, Tappet

Part No.	Description
1	QR82821
2	QT20073



4045D 4.5 Powertech®

350 Series 4.5 Litres 4 Cylinders

	Part No.	Description	96000 Standard Overhaul Kit	96010 .010" Kit
1	QRE505110	Cylinder Kit* Bore106.5	4	4
1A	QAR65507	O Ring Kit	4	4
2	QRE501455	Gasket Set*	1	1
3	QR115299	Balance Bush	6	6
4	QR119874	Cam Bush	1	1
5	QR123960	Rod Bush	4	4
6	QRE65168	Thrust Bearing STD	1	
7	QRE65908	Rod Bearing STD	4	
8	QRE65165	Main Bearing STD	4	
9	QRE65912	Thrust Bearing 10 Thou		1
10	QRE65909	Rod Bearing 10 Thou		4
11	QRE65911	Main Bearing 10 Thou		4



*Gasket Set

Gasket Set QRE501455 Contains		
R116515-B	Gasket, Cyl Head, 4.5 PT	1
RE516340	Seal, Crankshaft, Front	1
RE44574	SEAL,CRANKSHAFT,REAR	1
R92097-B	Gasket, Turbo Mount	1
R123226-B	Seal, Water Bypass Tube	2
R90658-B	Gasket, Exhaust Manifold	4
R123570-B	Gasket, Turbo Oil Drain	1
R54638-B	Gasket, Thermostat Cover, Dual	1
R123345-B	Gasket, Tstat Housing	1
R121416-B	Gasket, Water Pump To Head	1
R81275-B	Gasket, Air Inlet	2
R123575-B	O-Ring	4
R503891-B	Gasket, Turbo Oil Drain	1
R136516-B	Gasket, Timing Cover	1
R136515-B	Gasket, Timing Cover	1
R520131-B	Gasket, Timing Cover	1

R520132-B	Gasket, Timing Cover	1
A4827R-B	Washer, Special Aluminum	1
R123501-B	Gasket, Oil Cooler Housing	1
R502864-B	Gasket, Remote OF Adapter	1
R53108-B	Gasket, Starter to Block	1
R72328-B	O-Ring, Turbo Return/Water	4
R123273-B	O-Ring, Fuel Pump	1
R89944-B	O-Ring, Injector Pump Mount	1
R61105-B	O-Ring, Tube to Timing Cover	2
T122075-B	O-Ring	2
R500374-B	Gasket, Oil Filter Header	1
R123525-B	Gasket, Oil Filter Header	1
R501428-B	Gasket, Coolant Passage	1
R123417-B	Gasket, Water Pump	1
R502902-B	Packing, Oil Fill Cap	1
R136495-B	Gasket, Oil Fill Cover	3

Rod Bolts

Part No.	Description	Qty.	Note
QR114083	Rod Bolt	8	For Con Rods Marked: R123959 (64mm Long)
QR501124	Rod Bolt Long	8	For Con Rods Marked: R500000 (61mm Long)

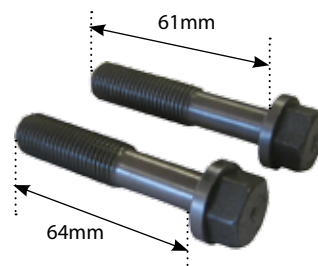

Gaskets

Gaskets			
	Part No.	Description	Qty.
1	QRE66082	Head Set	1
2	QRP793	Sump Set	1

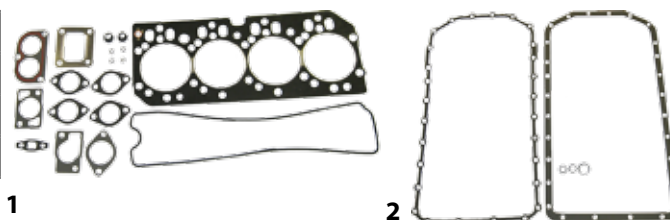

Valve Kit

Valve Kit 59240 Contains			
	Part No.	Description	Qty.
1	QR98062	Valve, Intake	4
2	QR90692	Valve, Exhaust	4
3	QR85687	Valve Seat, Exhaust	4
4	QR98063	Valve Seat, Intake	4
5	QRE60005	Rotator, Intake & Exhaust	8
6	QR26125	Spring, Valve, Intake & Exhaust	8
7	QR91889	Lock, Valve, Intake & Exhaust	16
8	QRE31617	Cap, Valve Stem	8



For Tractors with 4 Valve Cylinders

	Part No.	Description	Qty.
1	QR502370	Valve, Exhaust	8
2	QR502369	Valve, Inlet	8

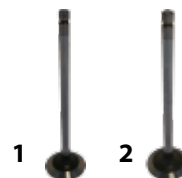

Ring Sets & Balancer Shafts

	Part No.	Description
1	QRE66271	Ring Sets
2	QRE500448	Balancer Shaft Right
3	QRE500449	Balancer Shaft Left

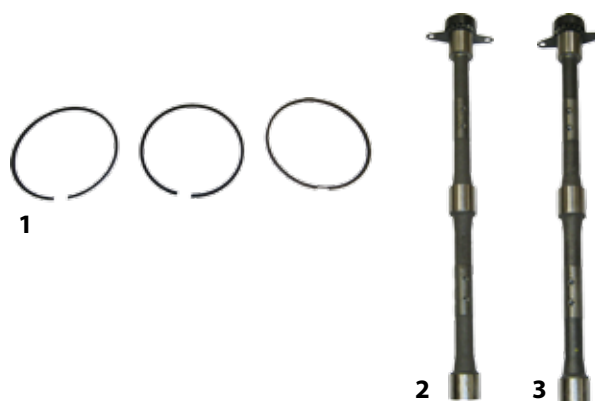

	Part No.	Description	98000 Standard Overhaul Kit	98010 .010" Kit
1	QRE507920	Cylinder Kit* Bore 106.5	4	4
1A	QAR65507	O Ring Kit Liner Seals	1	1
2	QRE501455	Gasket Set	1	1
3	QR115299	Balance Bush	6	6
4	QR119874	Cam Bush	1	1
5	QR123960	Rod Bush	4	4
6	QRE65168	Thrust Bearing STD	1	
7	QRE65908	Rod Bearing STD	4	
8	QRE65165	Main Bearing STD	4	
9	QRE65912	Thrust Bearing 10 Thou		1
10	QRE65909	Rod Bearing 10 Thou		4
11	QRE65911	Main Bearing 10 Thou		4



*Gasket Set

Gasket Set QRE501455 Contains		
R116515-B	Gasket, Cyl Head, 4.5 PT	1
RE516340	Seal, Crankshaft, Front	1
RE44574	SEAL,CRANKSHAFT,REAR	1
R92097-B	Gasket, Turbo Mount	1
R123226-B	Seal, Water Bypass Tube	2
R90658-B	Gasket, Exhaust Manifold	4
R123570-B	Gasket, Turbo Oil Drain	1
R54638-B	Gasket, Thermostat Cover, Dual	1
R123345-B	Gasket, Tstat Housing	1
R121416-B	Gasket, Water Pump To Head	1
R81275-B	Gasket, Air Inlet	2
R123575-B	O-Ring	4
R503891-B	Gasket, Turbo Oil Drain	1
R136516-B	Gasket, Timing Cover	1
R136515-B	Gasket, Timing Cover	1
R520131-B	Gasket, Timing Cover	1

R520132-B	Gasket, Timing Cover	1
A4827R-B	Washer, Special Aluminum	1
R123501-B	Gasket, Oil Cooler Housing	1
R502864-B	Gasket, Remote OF Adapter	1
R53108-B	Gasket, Starter to Block	1
R72328-B	O-Ring, Turbo Return/Water	4
R123273-B	O-Ring, Fuel Pump	1
R89944-B	O-Ring, Injector Pump Mount	1
R61105-B	O-Ring, Tube to Timing Cover	2
T122075-B	O-Ring	2
R500374-B	Gasket, Oil Filter Header	1
R123525-B	Gasket, Oil Filter Header	1
R501428-B	Gasket, Coolant Passage	1
R123417-B	Gasket, Water Pump	1
R502902-B	Packing, Oil Fill Cap	1
R136495-B	Gasket, Oil Fill Cover	3

Rod Bolts

Part No.	Description	Qty.	Note
QR114083	Rod Bolt	8	For Con Rods Marked: R123959 (64mm Long)
QR501124	Rod Bolt Long	8	For Con Rods Marked: R500000 (61mm Long)

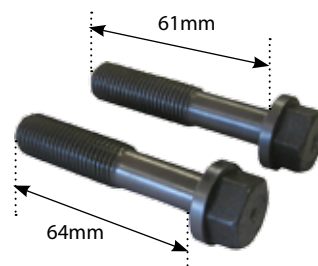

Gaskets

	Part No.	Description	Qty.
1	QRE66082	Head Set	1
2	QRP793	Sump Gasket Set	1

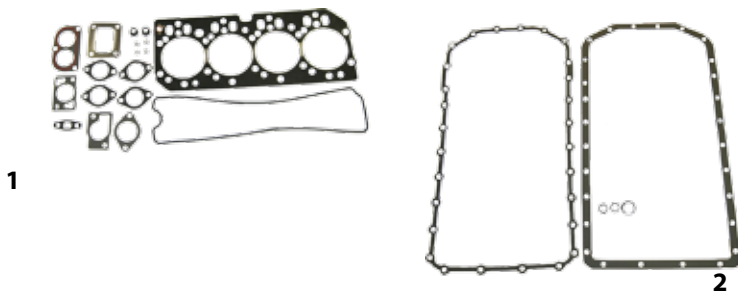

Valve Kit

Valve Kit 59235 Contains			
	Part No.	Description	Qty.
1	QR98062	Valve, Intake	4
2	QR90692	Valve, Exhaust	4
3	QR85687	Valve Seat, Exhaust	4
4	QR98063	Valve Seat, Intake	4
5	QRE60005	Rotator, Intake & Exhaust	8
6	QR26125	Spring, Valve, Intake & Exhaust	8
7	QR91889	Lock, Valve, Intake & Exhaust	16
8	QRE31617	Cap, Valve Stem	8



Ring Sets

	Part No.	Description
1	QRE507852	Ring Sets
2	QRE500448	Balancer Shaft Right
3	QRE500449	Balancer Shaft Left

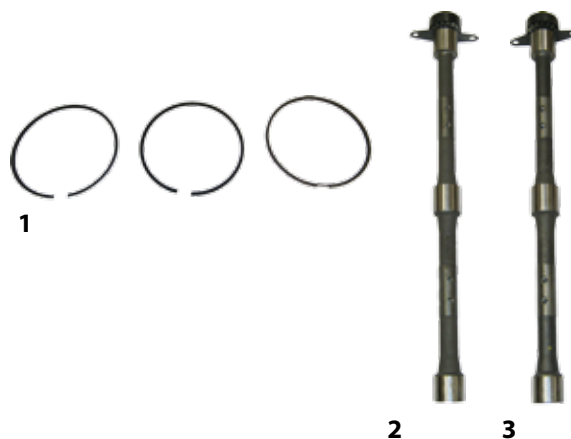

6068D 6.8D Powertech®

350 Series 6.8 Litres 6 Cylinders

	Part No.	Description	97000 Standard Overhaul Kit	97010 .010" Kit
1	QRE505110	Cylinder Kit Bore 106.5	6	6
1A	QAR65507	O Ring Kit	6	6
2	QRE501456	Gasket Set	1	1
3	QR119874	Cam Bush	1	1
4	QR123960	Rod Bush	6	6
5	QRE65168	Thrust Bearing STD	1	
6	QRE65908	Rod Bearing STD	6	
7	QRE65165	Main Bearing STD	6	
8	QRE65912	Thrust Bearing 10 Thou		1
9	QRE65909	Rod Bearing 10 Thou		6
10	QRE65911	Main Bearing 10 Thou		6

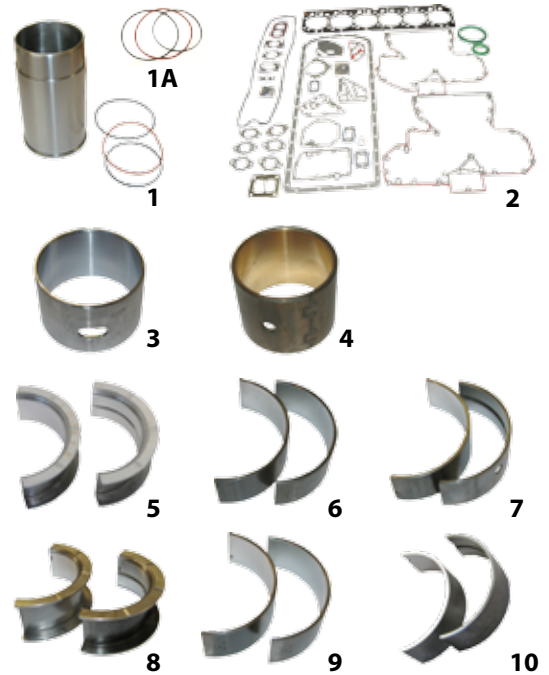

*Gasket Set

Gasket Set QRE501456 Contains			
RE516340	Seal, Crankshaft, Front	1	
RE516340-B	Seal, Crankshaft, Front	1	
RE44574	Seal, Crankshaft, Rear	1	
R116516-B	Gasket, Cyl Head, 6.8 PT	1	
R123572-B	Gasket, Turbo Mount	1	
R123226-B	Seal, Water Bypass Tube	2	
R90658-B	Gasket, Exhaust Manifold	6	
R123570-B	Gasket, Turbo Oil Drain	1	
R54638-B	Gasket, Thermostat Cover, Dual	1	
R123345-B	Gasket, Tstat Housing	1	
R121416-B	Gasket, Water Pump To Head	1	
R81275-B	Gasket, Air Inlet	2	
R123575-B	O-Ring	6	
R136516-B	Gasket, Timing Cover	1	
R136515-B	Gasket, Timing Cover	1	
R520131-B	Gasket, Timing Cover	1	

R520131-B	Gasket, Timing Cover	1	
R520132-B	Gasket, Timing Cover	1	
A4827R-B	Washer, Special Aluminum	1	
R123501-B	Gasket, Oil Cooler Housing	1	
R502864-B	Gasket, Remote OF Adapter	1	
R53108	Gasket, Starter to Block	1	
R72328-B	O-Ring, Turbo Return/Water	4	
R123273-B	O-Ring, Fuel Pump	1	
R89944	O-Ring, Injector Pump Mount	1	
R61105-B	O-Ring, Tube to Timing Cover	2	
T122075-B	O-Ring	2	
R500374-B	Gasket, Oil Filter Header	1	
R123525-B	Gasket, Oil Filter Header	1	
R501428-B	Gasket, Coolant Passage	1	
R123417-B	Gasket, Water Pump	1	
R502902-B	Packing, Oil Fill Cap	1	
R136495-B	Gasket, Oil Fill Cover	3	

Cylinder Kit Tier II

QRE516227

Cylinder Kit Tier II John Deere 6320 6420



Rod Bolts

Part No.	Description	Qty.	Note
QR114083	Rod Bolt	12	For Con Rods Marked: R123959 (64mm Long)
QR501124	Rod Bolt Long	12	For Con Rods Marked: R500000 (61mm Long)

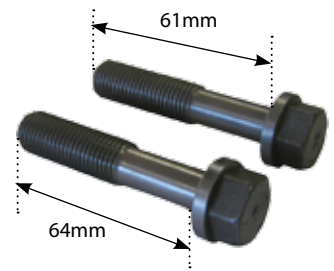

Gaskets

	Part No.	Description	Qty.
1	QRE66083	Head Set	1
2	QRP794	Sump Gasket Set	1

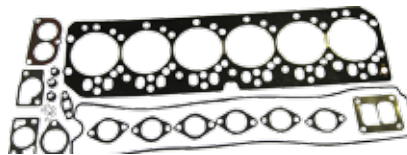

1

2

Valve Kit

Valve Kit 59235 Contains			
	Part No.	Description	Qty.
1	QR98062	Valve, Intake	6
2	QR90692	Valve, Exhaust	6
3	QR85687	Valve Seat, Exhaust	6
4	QR98063	Valve Seat, Intake	6
5	QRE60005	Rotator, Intake & Exhaust	12
6	QR26125	Spring, Valve, Intake & Exhaust	12
7	QR91889	Lock, Valve, Intake & Exhaust	24
8	QRE31617	Cap, Valve Stem	12



For Tractors with 4 Valve Cylinders

	Part No.	Description	Qty.
1	QR502370	Valve, Exhaust	12
2	QR502369	Valve, Inlet	12

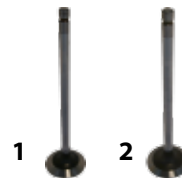

Ring Sets

	Part No.	Description
1	QRE66271	Ring Sets



1

6068T 6.8T Powertech®

350 Series 6.8 Litres 6 Cylinders

	Part No.	Description	99000 Standard Overhaul Kit	99010 .010" Kit
1	QRE507920		6	6
1A	QAR65507	O Ring Kit	6	6
2	QRE501456	Gasket Set*	1	1
3	QR119874	Cam Bush	1	1
4	QR123960	Rod Bush	6	6
5	QRE65168	Thrust Bearing STD	1	
6	QRE65908	Rod Bearing STD	6	
7	QRE65165	Main Bearing STD	6	
8	QRE65912	Thrust Bearing 10 Thou		1
9	QRE65909	Rod Bearing 10 Thou		6
10	QRE65911	Main Bearing 10 Thou		6

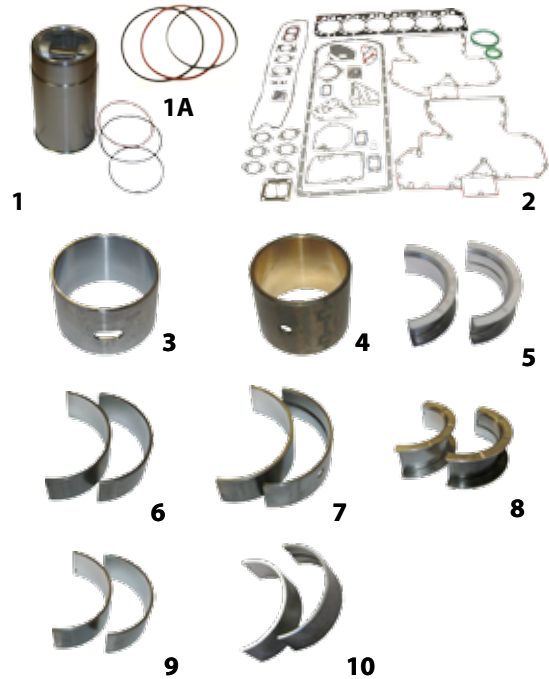

*Gasket Set

Gasket Set QRE501456 Contains			
RE516340	Seal, Crankshaft, Front	1	
RE516340-B	Seal, Crankshaft, Front	1	
RE44574	Seal, Crankshaft, Rear	1	
R116516-B	Gasket, Cyl Head, 6.8 PT	1	
R123572-B	Gasket, Turbo Mount	1	
R123226-B	Seal, Water Bypass Tube	2	
R90658-B	Gasket, Exhaust Manifold	6	
R123570-B	Gasket, Turbo Oil Drain	1	
R54638-B	Gasket, Thermostat Cover, Dual	1	
R123345-B	Gasket, Tstat Housing	1	
R121416-B	Gasket, Water Pump To Head	1	
R81275-B	Gasket, Air Inlet	2	
R123575-B	O-Ring	6	
R136516-B	Gasket, Timing Cover	1	
R136515-B	Gasket, Timing Cover	1	
R520131-B	Gasket, Timing Cover	1	

R520131-B	Gasket, Timing Cover	1	
R520132-B	Gasket, Timing Cover	1	
A4827R-B	Washer, Special Aluminum	1	
R123501-B	Gasket, Oil Cooler Housing	1	
R502864-B	Gasket, Remote OF Adapter	1	
R53108	Gasket, Starter to Block	1	
R72328-B	O-Ring, Turbo Return/Water	4	
R123273-B	O-Ring, Fuel Pump	1	
R89944	O-Ring, Injector Pump Mount	1	
R61105-B	O-Ring, Tube to Timing Cover	2	
T122075-B	O-Ring	2	
R500374-B	Gasket, Oil Filter Header	1	
R123525-B	Gasket, Oil Filter Header	1	
R501428-B	Gasket, Coolant Passage	1	
R123417-B	Gasket, Water Pump	1	
R502902-B	Packing, Oil Fill Cap	1	
R136495-B	Gasket, Oil Fill Cover	3	

Rod Bolts

Part No.	Description	Qty.	Note
QR114083	Rod Bolt	12	For Con Rods Marked: R123959 (64mm Long)
QR501124	Rod Bolt Long	12	For Con Rods Marked: R500000 (61mm Long)

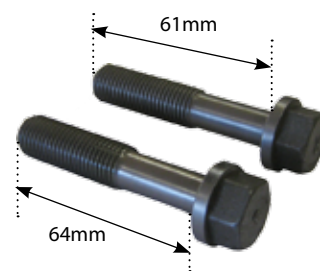

Gaskets

	Part No.	Description	Qty.
1	QRE66083	Head Set	1
2	QRP794	Sump Gasket Set	1

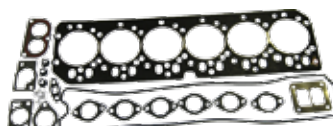

1



2

Valve Kit

Valve Kit 59235 Contains			
	Part No.	Description	Qty.
1	QR98062	Valve, Intake	6
2	QR90692	Valve, Exhaust	6
3	QR85687	Valve Seat, Exhaust	6
4	QR98063	Valve Seat, Intake	6
5	QRE60005	Rotator, Intake & Exhaust	12
6	QR26125	Spring, Valve, Intake & Exhaust	12
7	QR91889	Lock, Valve, Intake & Exhaust	24
8	QRE31617	Cap, Valve Stem	12



Ring Sets

	Part No.	Description
1	QRE507852	Ring Sets



1

4045T Turbo High Horsepower 4.5T Powertech®

350 Series 4.5 Litres 4 Cylinders

	Part No.	Description	99500 Standard Overhaul Kit	99510 .010" Kit
1	QRE507850	Cylinder Kit 106.5 Bore	4	4
1A	QAR65507	O Ring Kit	4	4
2	QRE501455	Gasket Set*	1	1
3	QR115299	Balance Bush	6	6
4	QR119874	Cam Bush	1	1
5	QR114082	Rod Bush	4	4
6	QRE65168	Thrust Bearing STD	1	
7	QRE65908	Rod Bearing STD	4	
8	QRE65165	Main Bearing STD	4	
9	QRE65912	Thrust Bearing 10 Thou		1
10	QRE65909	Rod Bearing 10 Thou		4
11	QRE65911	Main Bearing 10 Thou		4



*Gasket Set

Gasket Set QRE501455 Contains		
R116515-B	Gasket, Cyl Head, 4.5 PT	1
RE516340	Seal, Crankshaft, Front	1
RE44574	SEAL,CRANKSHAFT,REAR	1
R92097-B	Gasket, Turbo Mount	1
R123226-B	Seal, Water Bypass Tube	2
R90658-B	Gasket, Exhaust Manifold	4
R123570-B	Gasket, Turbo Oil Drain	1
R54638-B	Gasket, Thermostat Cover, Dual	1
R123345-B	Gasket, Tstat Housing	1
R121416-B	Gasket, Water Pump To Head	1
R81275-B	Gasket, Air Inlet	2
R123575-B	O-Ring	4
R503891-B	Gasket, Turbo Oil Drain	1
R136516-B	Gasket, Timing Cover	1
R136515-B	Gasket, Timing Cover	1
R520131-B	Gasket, Timing Cover	1

R520132-B	Gasket, Timing Cover	1
A4827R-B	Washer, Special Aluminum	1
R123501-B	Gasket, Oil Cooler Housing	1
R502864-B	Gasket, Remote OF Adapter	1
R53108-B	Gasket, Starter to Block	1
R72328-B	O-Ring, Turbo Return/Water	4
R123273-B	O-Ring, Fuel Pump	1
R89944-B	O-Ring, Injector Pump Mount	1
R61105-B	O-Ring, Tube to Timing Cover	2
T122075-B	O-Ring	2
R500374-B	Gasket, Oil Filter Header	1
R123525-B	Gasket, Oil Filter Header	1
R501428-B	Gasket, Coolant Passage	1
R123417-B	Gasket, Water Pump	1
R502902-B	Packing, Oil Fill Cap	1
R136495-B	Gasket, Oil Fill Cover	3

Cylinder Kit Tier II

QRE516227

Cylinder Kit Tier II John Deere 6320 6420



Rod Bolts

Part No.	Description	Qty.	Note
QR114083	Rod Bolt	8	For Con Rods Marked: R123959 (64mm Long)
QR501124	Rod Bolt Long	8	For Con Rods Marked: R500000 (61mm Long)

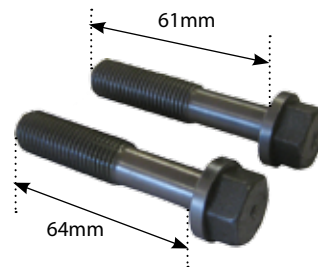

Gaskets

	Part No.	Description	Qty.
1	QRE66082	Head Set	1
2	QRP793	Sump Gasket Set	1

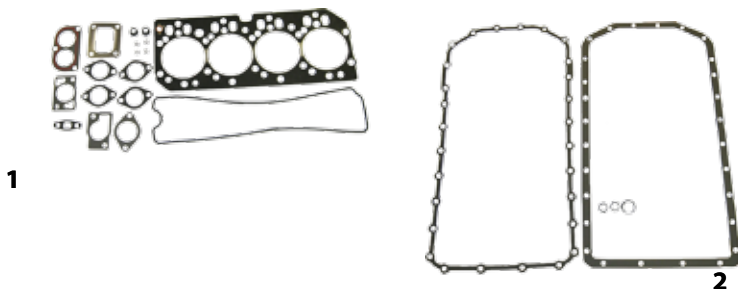

Valve Kit

Valve Kit 59240 Contains			
	Part No.	Description	Qty.
1	QR98062	Valve, Intake	4
2	QR90692	Valve, Exhaust	4
3	QR85687	Valve Seat, Exhaust	4
4	QR98063	Valve Seat, Intake	4
5	QRE60005	Rotator, Intake & Exhaust	8
6	QR26125	Spring, Valve, Intake & Exhaust	8
7	QR91889	Lock, Valve, Intake & Exhaust	16
8	QRE31617	Cap, Valve Stem	8



For Tractors with 4 Valve Cylinders

	Part No.	Description	Qty.
1	QR502370	Valve, Exhaust	8
2	QR502369	Valve, Inlet	8

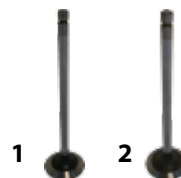

Ring Sets

	Part No.	Description
1	QRE507852	Ring Sets
2	QRE500448	Balancer Shaft Right
3	QRE500449	Balancer Shaft Left

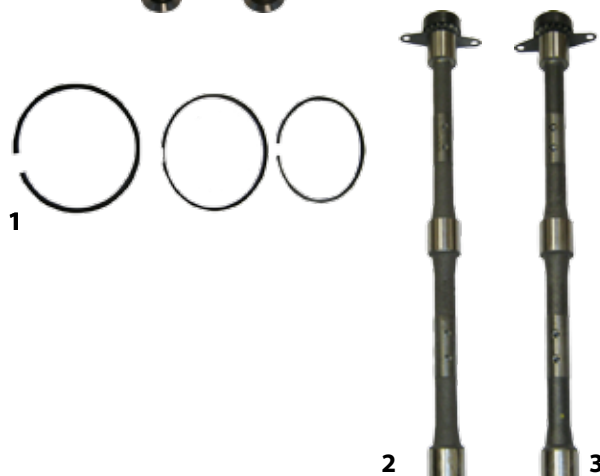

6068H Turbo High Horsepower 6.8T High Horse Powertech®

350 Series 6.8 Litres 6 Cylinders

	Part No.	Description	Standard Overhaul Kit 99600	.010" Kit 99610
1	QRE507850	Cylinder Kit Bore 106.5	6	6
1A	QAR65507	O Ring Kit	6	6
2	QRE501456	Gasket Set*	1	1
3	QR119874	Cam Bush	1	1
4	QR114082	Rod Bush	6	6
5	QRE65168	Thrust Bearing STD	1	
6	QRE65908	Rod Bearing STD	6	
7	QRE65165	Main Bearing STD	6	
8	QRE65912	Thrust Bearing 10 Thou		1
9	QRE65909	Rod Bearing 10 Thou		6
10	QRE65911	Main Bearing 10 Thou		6

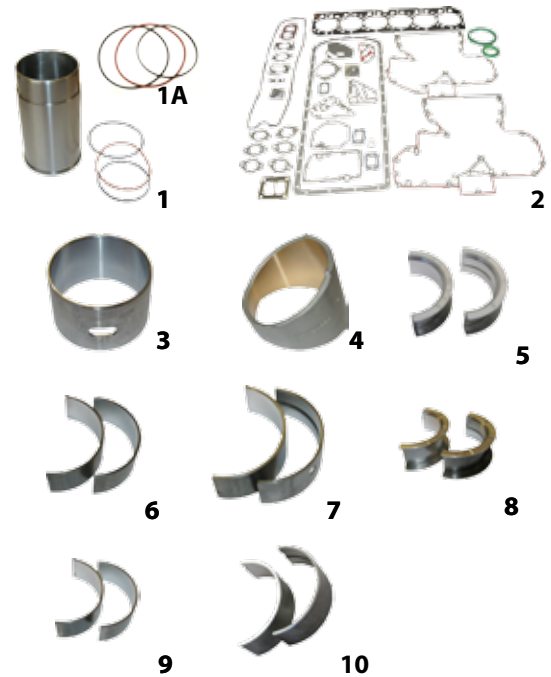

*Gasket Set

Gasket Set QRE501456 Contains		
NRE516340	Seal, Crankshaft, Front	1
NRE516340-B	Seal, Crankshaft, Front	1
NRE44574	Seal, Crankshaft, Rear	1
NR116516-B	Gasket, Cyl Head, 6.8 PT	1
NR123572-B	Gasket, Turbo Mount	1
NR123226-B	Seal, Water Bypass Tube	2
NR90658-B	Gasket, Exhaust Manifold	6
NR123570-B	Gasket, Turbo Oil Drain	1
NR54638-B	Gasket, Thermostat Cover, Dual	1
NR123345-B	Gasket, Tstat Housing	1
NR121416-B	Gasket, Water Pump To Head	1
NR81275-B	Gasket, Air Inlet	2
NR123575-B	O-Ring	6
NR136516-B	Gasket, Timing Cover	1
NR136515-B	Gasket, Timing Cover	1
NR520131-B	Gasket, Timing Cover	1

NR520132-B	Gasket, Timing Cover	1
NA4827R-B	Washer, Special Aluminum	1
NR123501-B	Gasket, Oil Cooler Housing	1
NR502864-B	Gasket, Remote OF Adapter	1
NR53108	Gasket, Starter to Block	1
NR72328-B	O-Ring, Turbo Return/Water	4
NR123273-B	O-Ring, Fuel Pump	1
NR89944	O-Ring, Injector Pump Mount	1
NR61105-B	O-Ring, Tube to Timing Cover	2
NT122075-B	O-Ring	2
NR500374-B	Gasket, Oil Filter Header	1
NR123525-B	Gasket, Oil Filter Header	1
NR501428-B	Gasket, Coolant Passage	1
NR123417-B	Gasket, Water Pump	1
NR502902-B	Packing, Oil Fill Cap	1
NR136495-B	Gasket, Oil Fill Cover	3

Tier II Cylinder Kit

QRE516227

Cylinder Kit Tier II John Deere
6320 6420 6520 6620 6820
6920



Rod Bolts

Part No.	Description	Qty.	Note
QR114083	Rod Bolt	12	For Con Rods Marked: R123959 (64mm Long)
QR501124	Rod Bolt Long	12	For Con Rods Marked: R500000 (61mm Long)

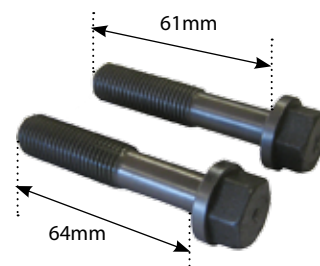

Gaskets

	Part No.	Description	Qty.
1	QRE66083	Head Set	1
2	QRP794	Sump Gasket Set	1

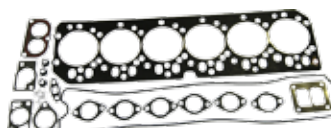

1



2

Valve Kit

Valve Kit 59235 Contains			
	Part No.	Description	Qty.
1	QR98062	Valve, Intake	6
2	QR90692	Valve, Exhaust	6
3	QR85687	Valve Seat, Exhaust	6
4	QR98063	Valve Seat, Intake	6
5	QRE60005	Rotator, Intake & Exhaust	12
6	QR26125	Spring, Valve, Intake & Exhaust	12
7	QR91889	Lock, Valve, Intake & Exhaust	24
8	QRE31617	Cap, Valve Stem	12



For Tractors with 4 Valve Cylinders

	Part No.	Description	Qty.
1	QR502370	Valve, Exhaust	12
2	QR502369	Valve, Inlet	12

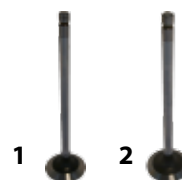

Ring Sets

Part No.	Description
QRE507852	Ring Sets



6466T Engine Type

400 Series 466 inches 6 Cylinders



RELIANCE

	Part No.	Description	Bore
1	QRE60288	Cylinder Kit	116
1A	QAR98850	O Ring Kit	
2	QR98845	Gasket Set	
3	QAR77748	Thrust Bearing STD	
4	QAR77747	Thrust Washer Set	
5	QRE22764	Seal Rear Crank	
6	QR26115	Cup Plug, Camshaft	
7	QAR73277	Rod Bearing STD	
8	QR46903	Cam Bushing	
9	QR60724	Gudgeon Bushing	
10	QAR74814	Main Bearing STD	



5



6



7



8



9



10

6076T, A, H Engine Type



RELIANCE



QRE60297
Cylinder Kit Low Ring Engine 6076
Models 4955 4960 8560 8570



QRE60294
Cylinder Kit High Ring Engine 6076
Models 455 4755 7600 7700 7800
8100 8200 8300 8400

4045 6068 HL Engine Type

QRE536083
Cylinder Kit John Deere 4045H
6068HL Bore 106.5
OE Ref: RE536083RE536083



6081A High Compression Engines

450 Series 8.1 Litres 6 Cylinders

	Part No.	Description	99700 Standard Overhaul Kit	99710 .010" Kit	Bore
1	QRE64509	Cylinder Kit	6	6	116
1A	QAR98850	O Ring Kit			
2	QRE57187	Gasket Set*	1	1	
3	QAR49025	Seal Front	1	1	
4	QRE61253	Thrust Washer for Flange-less Bearing	1	1	
5	QR87561	Cam Bush	1	1	
6	QR74008	Rod Bush	6	6	
7	QRE520036	Seal Rear	1	1	
8	QR82007	Cup Plug, Camshaft	1	1	
9	QRE504198	Thrust Bearing Pair	1	0	
10	QR525767	Rod Bearing STD	6	0	
11	QRE529319	Main Bearing STD	6	0	
12	QRE504199	Thrust Bearing 10 Thou		1	
13	QRE534185	Rod Bearing 10 Thou		6	
14	QRE534181	Main Bearing 10 Thou		6	



*Gasket Set

Gasket Set QRE57187 Contains		
R83020-B	Gasket, Exhaust Manifold,	2
R83021-B	Gasket, Exhaust Manifold,	2
R88397-B	Gasket, Water Manifold Mount	2
R64840-B	Washer, Inj to Cyl Head	6
R77551-B	O-Ring, Fuel Injector Fitting	6
R51603-B	O-Ring, Fuel Injector	6
R124607-B	Gasket, Thermostat Cover, Dual	1
R102838-B	Gasket, Intake Manifold	3
R86743-B	O-Ring, Aftercooler	1
R50405-B	O-Ring, Intake Coupling	1
R50406-B	O-Ring, Intake Coupling	1
R89879-B	Gasket, Turbo Mount	1
R105346-B	Gasket, Turbo Oil Outlet	1
R86062-B	Gasket, T-Stat Housing to Head	1
R120646-B	Gasket, Intake Manifold	3
R119383-B	Gasket, Water Pump Cover	1
R502011-B	Gasket, Inj Pump Cover	1
R53108-B	Gasket, Starter to Block	1
R119847-B	Gasket, Oil Press Regulator	1
R26058-B	Gasket, C/S Seal Housing	1
R100569-B	Gasket, Oil Pump Intake	1
R132396-B	Gasket, Oil Cooler Cover	1
R50424-B	Gasket, Oil Cooler Adapter	1

R124030-B	Gasket, Oil Cooler Adapter	1
NR100911-B	Seal, Intercooler End	1
NT20328-B	Gasket, Oil Filler Cap	1
NR47153-B	O-Ring, Oil Cooler Tube	8
NU17409-B	O-Ring, Bypass Nut	3
NU13639-B	O-Ring, Coolant Heater Plug	1
51M4237	Washer, Copper	2
51M4238	Washer, Copper	2
R50417-B	Gasket, Oil Cooler to Block	1
R54856-B	O-Ring	1
R109625-B	Gasket, Oil Pump Housing	1
R49866-B	Gasket, Rocker Cover, 404, 466	1
R119384-B	Gasket, Timing Gear Cover	1
R88993-B	Gasket, Intercooler	2
R521228-B	Gasket, Oil Pan	1
RE47336-B	Gasket, Cyl Head, Premium	1

Rod Bolts

Part No.	Description	Qty.
QR501035	Rod Bolt (24mm Long)	12



Gaskets

Gaskets			
	Part No.	Description	Qty.
1	QRE57186	Head Set	1
2	59182	Rocker Cover Gasket	1
3	59183	Rocker Cover Gasket Upper	1

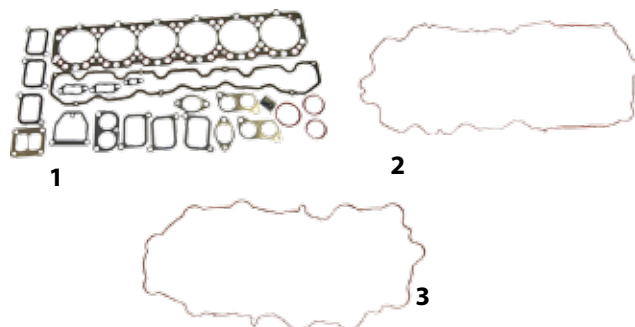

This gasket set includes a cork rocker cover gasket. After Serial No. 200,000 you need to use a 2 piece rubber rocker cover gasket 59182 59183

Valve Kit

Valve Kit 59234 Contains			
	Part No.	Description	Qty.
1	QR84618	Valve, Intake	6
2	QR84619	Valve, Exhaust	6
3	QR91822	Spring, Valve, Intake & Exhaust	12
4	QT20077	Lock, Valve, Intake & Exhaust	24
5	QT20129	Cap, Valve Stem	12

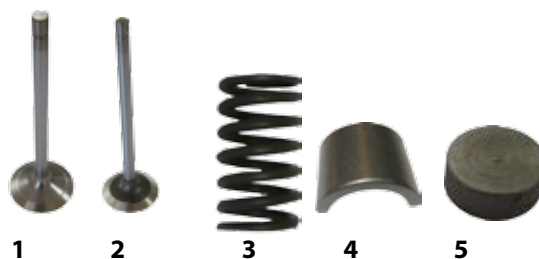

For Tractors with 4 Valve Cylinders

	Part No.	Description	Qty.
1	QR502370	Valve, Exhaust	12
2	QR502369	Valve, Inlet	12

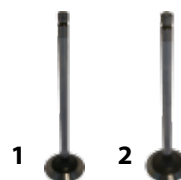

Ring Sets

Part No.	Description
QRE503528	Ring Sets



6068 24 Valve Tier 3 Engines

6530 Premium 6630 Premium 6830 Premium 6930 Premium



RELIANCE

Part No.	Description
1	QRE524450 Cylinder Kit
2	QRE530613 Piston Ring Set
3	QRE531221 Valve Inlet
4	QR502370 Valve Exhaust
5	QRE527832 Head Gasket Set
6	59568 Valve Seal
7	59569 Valve Spring
8	59567 Seat Exhaust Valve
9	59570 Seat Inlet Valve

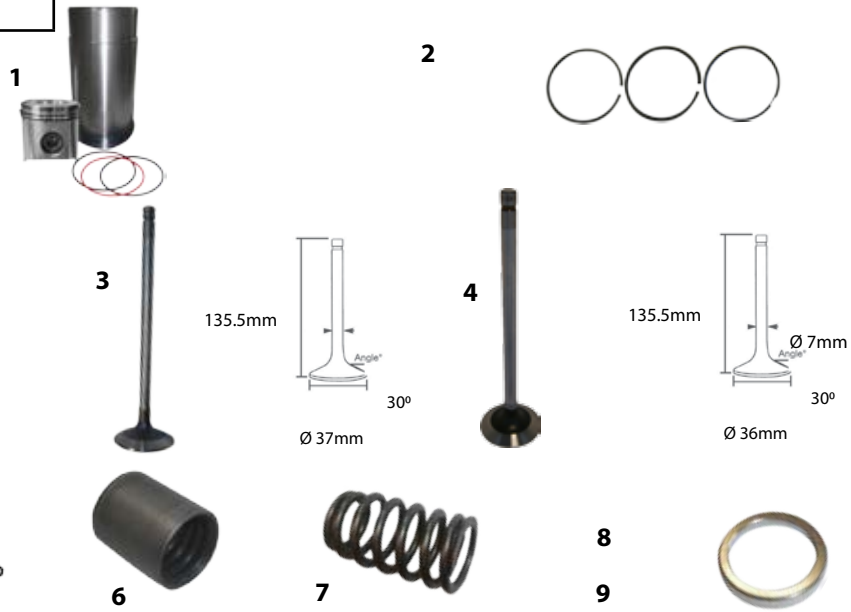

6068 24 Valve Tier 2 Engines

Part No.	Description
1	QRE516227 Cylinder Kit
2	QRE527014 Head Gasket Set

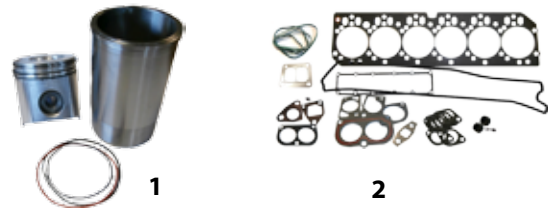

4045 16 Valve Tier 2 & Tier 3 Engines

Part No.	Description
1	QRE524450 Cylinder Kit TIER 3
2	QRE516227 Cylinder Kit TIER 2
3	QRE532842 Head Gasket Set TIER 3
4	QRE526670 Head Gasket Set TIER 2
5	QRE531221 Valve Inlet
6	QR502370 Valve Exhaust
7	59568 Valve Seal
8	59567 Seat Exhaust Valve
9	59570 Seat Inlet Valve

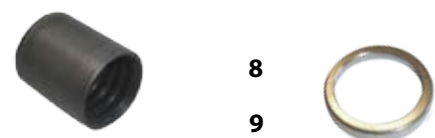
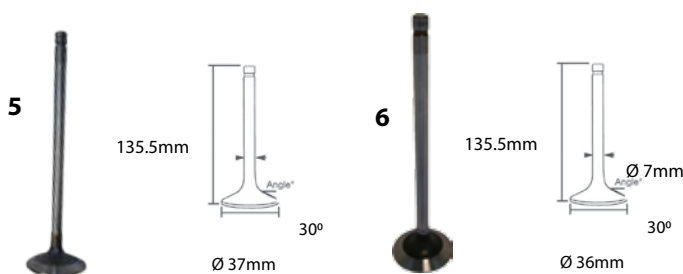
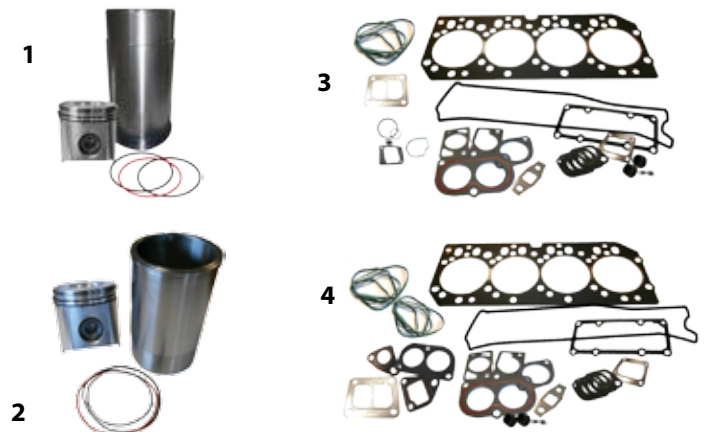

Date:.....

No. of Pages:.....

Name of the Rep.....

A/C Number:.....

From:.....

e-mail.....

Phone No.:.....

Fax No.:.....

Please quote for the following parts - Quotation Number :

I wish to confirm the following order on Quotation Number:

Please supply the following parts:

Please photocopy this page

Please do not remove this page

Qty	Part No.	Description	Unit Price
1.			
2.			
3.			
4.			
5.			
6.			
7.			
8.			
9.			
10.			
11.			
12.			
13.			
14.			
15.			
16.			
17.			
18.			
19.			
20.			
21.			
22.			
23.			
24.			

Comments:

Customer Signature: _____ **Rep's Signature:** _____

Tel No: + 353 44 934 1638

e-mail: info@qtponline.com, www.qtponline.com

Page of



Q3802060
Piston Standard Non Turbo
Cummins B Series Case IH
5130 5230 Engine 6-590

Q3802062
Piston 0.50mm Non
Turbo Cummins B
Series Case IH 5130
5230 Engine 6-590

Q3802100
Piston Standard Turbo
Cummins B Series
Case IH 5140 5150
5120 6590

Q3802102
Piston 0.50mm Turbo
Cummins B Series
Case IH 5140 5150
5120 6590

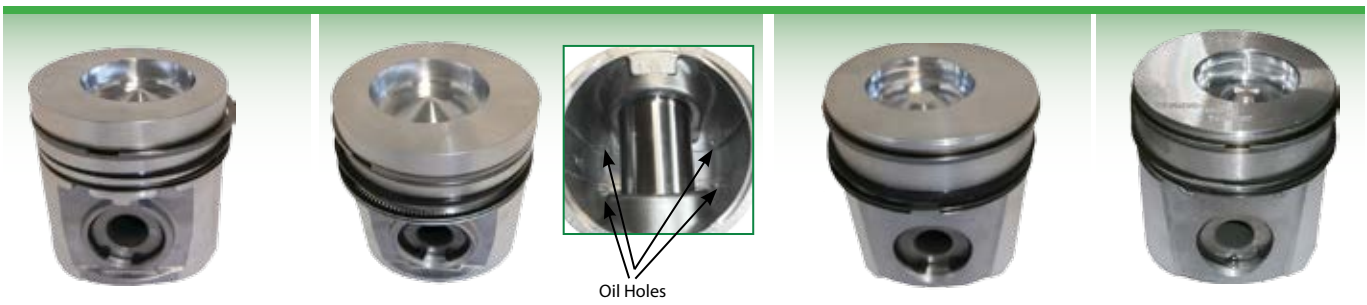

Q3802160
Piston Standard Turbo
Cummins B Series
Case IH 5120 5140 5150
5220 5240 5250

Q3802132
Piston 0.50mm Turbo
Cummins B Series
Case IH 5120 5140 5150
5220 5240 5250

Oil Holes

Q3802747
Piston Standard Turbo
Cummins B Series Case
IH MX100 MX110 MX120
MX135 MX150MX170

Q3802764
Piston 0.50mm Turbo
Cummins B Series Case
IH MX100 MX110 MX120
MX135 MX150MX170



Q3802040
Ring Set Standard
Non Turbo Cummins B
Series Case IH 5130 5230
Engine 6-590

Q3802042
Ring Set 0.50mm Non
Turbo Cummins B
Series Case IH 5130 5230
Engine 6-590

Q3802421
Ring Set Standard Turbo
Cummins B Series Case
IH 5120 5140 5150 5220
5240 5250MX100 MX110
MX120 MX135 MX150
MX170

Q3802422
Ring Set 0.50mm Turbo
Cummins B Series Case
IH 5120 5140 5150 5220
5240 5250 MX100 MX110
MX120 MX135 MX150
MX170



Q3904166 Block Cylinder
Repair Sleeve Cummins B
Series Case IH 5120 5130
5140 5150 5220 5230
5240 5250 MX100 MX110
MX120 MX135 MX150
MX170

Q3802356
Valve Exhaust
Cummins B Engine
Case IH 5120 5130
5140 5150 5220
5230 5240 5250
MX100 MX110
MX120 MX135
MX150 MX170

Q3802355 Valve
Intake Cummins B
Engine Case IH 5120
5130 5140 5150
5220 5230 5240 5250
MX100 MX110 MX120
MX135 MX150 MX170

Q3900276
Valve Spring Exhaust &
Intake Cummins B Engin
Case IH 5120 5130 5140
5150 5220 5230 5240
5250 MX100 MX110
MX120 MX135 MX150
MX170

CUMMINS B ROD BEARINGS

Q3939859	3939859 A77465 K3543274	Standard
Q4932375	4932375	.25 mm
Q4932376	4932376	.50 mm

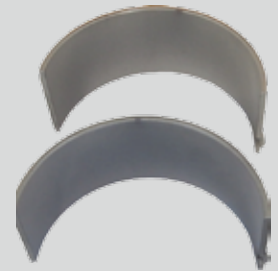

CUMMINS 4B MAIN BEARING SET

Q3802010	3802010 A77405 A77405X4+A77406 A77406	Standard
Q3802011	3802011	.25 mm
Q3802012	3802012	.50 mm

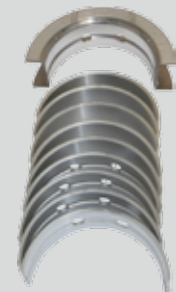

CUMMINS 6B MAIN BEARING SET

Q3802070	3802070 A77405 A77405X6+A77406 A77406 A77896	Standard
Q3802071	3802071 1484030	.25 mm
Q3802072	3802072 76192130	.50 mm



Q3901306
Cam Bush Cummins 4B 6B Engine ** 1 Per EngineCase IH 5130 5140 5150 5230 5240 5250MX100 MX110 MX120 MX135 MX150 MX1705120 5220
OE Ref:
3901306
J901306



Q4891178
Gudgeon Pin Bush Cummins 4B 6B Series EngineGudgeon Pin Bush Cummins 4B 6B Series Engine Case IH 5130 5140 5150 5230 5240 5250 MX100 MX110 MX120 MX135 MX150 MX170 5120 5220
OE Ref:
4891178
J891178



Q3900709
Crank Seal Front Cummins 4B 6B EngineCase IH 5130 5140 5150 5230 5240 5250MX100 MX110 MX120 MX135 MX150 MX1705120 5220
OE Ref:
3900709
J904353



Q3933262
Rear Seal Cummins 4B 6B EngineCase IH 5130 5140 5150 5230 5240 5250MX100 MX110 MX120 MX135 MX150 MX170 5120 5220
OE Ref:
3933262
J933262



Q3802338
Injector Cummins B Series
OE Ref:3802338



Q3280048
Injector Cummins B Series
OE Ref:3280048



Q3802677
Injector Cummins 6B Series- Case MX100,110,12
OE Ref:3802677 /71100629

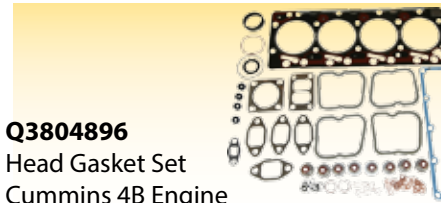

Q3804896
Head Gasket Set Cummins 4B Engine Case IH 5120 5220
OE Ref:
3804896
87405727
87434406
A77672
A77858



Q3802375
Sump Gasket Set Cummins 4B Engine Case IH 5120 5220
OE Ref:
3802375
A77671
A77860

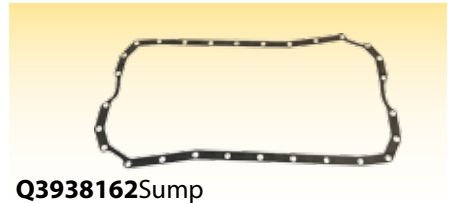

Q3938162Sump Gasket Cummins 4B Engine Case IH 5120 5220
OE Ref:
3938162
A77673

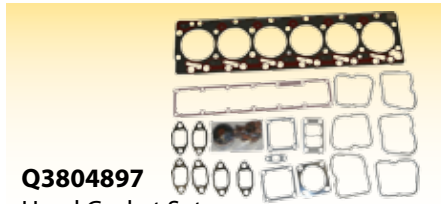

Q3804897
Head Gasket Set Cummins 6B Engine Case IH 5130 5140 5150 5230 5240 5250 MX100 MX110 MX120 MX135 MX150 MX170
OE Ref:
3804897
87434407
A77675
A77793
A77859



Q3802376
Sump Gasket Set Cummins 6B Engine Case IH 5130 5140 5150 5230 5240 5250
OE Ref:
3802376
A77491
A77674
A77861

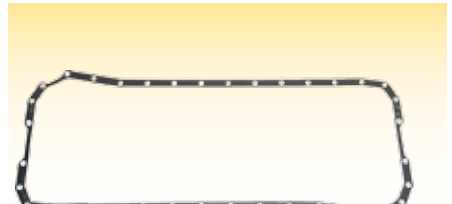

Q3959052
Sump Gasket Cummins 6B Engine Case IH 5130 5140 5150 5230 5240 5250
OE Ref:
3959052



41029
Water Pump Case Maxxum MX Cummins EngineNew Holland TSA / T Series 148mm Centre Hole 78mm ImpellerIHC 5120 5130 5140 5150 5220 5230 5240 5250
J802358
3286277
J286278



Q3937404
Oil Pump Cummins B SeriesCase IH 5130 5140 5150 5230 5240 5250MX100 MX110 MX120 MX135 MX150 MX170
OE Ref:
3937404
J937404
3930337



Q3957543
Oil Cooler Cummins B Series 4B Only
OE Ref:
3957543
87416027
J904320
JR904320
J918292 J921557

MAIN END BEARINGS MAJOR



42920	Standard	E554320M91
42921	10 Thou	E554322M91
42922	20 Thou	E554323M91
42923	30 Thou	554324M91

FORD 3000 4000 5000 7000 6600 6410 7600 7700 7610 7710

MAIN END BEARINGS

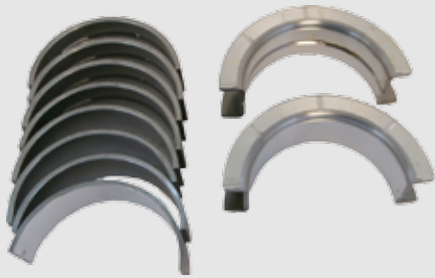

42928	Standard	81811582
42929	10 Thou	81811582
42930	20 Thou	81811586
42931	30 Thou	81881587

BIG END BEARINGS EARLY TYPE 36MM



42924	Standard	83906780
42925	10 Thou	83906783
42926	20 Thou	83906784
42927	30 Thou	83906785

BIG END BEARINGS LATER TYPE 32MM



42932	Standard	81876612
42933	10 Thou	83991761
42934	20 Thou	81817367
42935	30 Thou	81876616

42953

Piston c/o Rings Ford 2000 5000 7000
2100 2300 3100 3300 3600 4100 4200
4400 4600

OE Ref: 81877564



42952

Ring Set Ford 2000 5000 7000 2100 2300 3100 3300
3600 4100 4200 4400 4600

OE Ref: 81814543



42962

Piston c/o Rings Ford 5610 6610 6810 7010
(850179M>) 7610 5640 6640 7740 8160
8260 8360 Turbo 8560 Turbo TS100 TS110
TS80 T Turbo TM115 125 135
150 165 Fiat M135 M160 OE Ref: 87800435



42961

Ring Set Ford 5610S 6610S 6810S 7010 (850179M>)
7610S 5640 6640 7740 8160

OE Ref: 81866003



42956

Piston c/o Rings Ford 3100 3300 3600 3900
5100 (3/68>) 5200 (3/68>) 5600 (9/80>)
3000 5000 (3/68>) 3310 3150 5700 (9/80>)
3190 5190 (3/68>) OE Ref: 81817957



42955

Ring Set Ford 3100 3300 3600 3900 5100 (3/68>)
5200 (3/68>) 5600 (9/80>)

OE Ref: 81814535



42959

Piston c/o Rings Ford 6810 7410 7610
(8/87>) 7710 (8/87>)

OE Ref: 83960635



42966

Ring Set Ford 6810 7410 7610 (8/87>) 7710 (8/87 >)

OE Ref: DFPN6149E



42960

Piston c/o Rings
Ford 7010 7610S
7740 8340 Turbo

OE Ref: 81873456

42957

Piston c/o Rings
Ford 6610 (7/87>)
6710 7810 7910
(4/86>) 8210 (4/86>)
TW5 (4/86>) 4600 (Non Headland)
6600 (10/80>) 6700 4630
(Non Headland) 8530 (4/86>)

OE Ref: 81877563

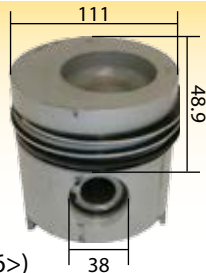

42958

Piston c/o Rings Ford 6410
6610 (8/87>) 6710 (8/87>)

OE Ref: 81877565

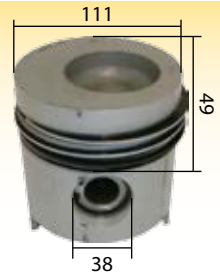

NEF

Q4897480

Oil Pump NEF Case New
Holland T6000 C190 L190

OE Ref: 4897480



Q4897481

Oil Pump NEF Case New
Holland T6000 CR5080

OE Ref: 4897481



Q2830559

Gasket Oil Cooler NEF Ford
TN85A T7030 T6030 T6050
TS115A TS130A TN95A
TL100A, T6040, T6020,
TS110A TL80A T6010 T705



Q2852743

Gasket Exhaust Manifold
NEF Ford TN85A T6030
T6050 TS115A TS130A
TN95A TL100A T6020
TS110A TL80A T6010 T6070





Q87317238
Piston Assy Non Turbo
Standard NEF IvecoEngine
Case New Holland TL80A
TL70A C190
OE Ref: 87317238

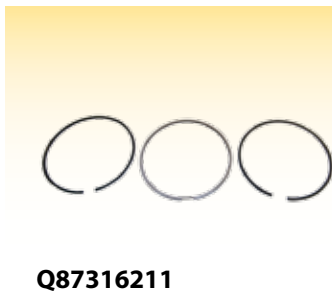

Q87316211
Ring Set Non Turbo
Standard NEF
IvecoEngine Case New
Holland TL70A TL80A
C190 L180
OE Ref: 87316211



Q87317243
Piston Assy Non Turbo
0.40mm NEF IvecoEngine
Case New Holland C190
L190
OE Ref: 87317243



Q87316213
Ring Set Non Turbo
0.40mm NEF IvecoEngine
Case New Holland C190
L190
OE Ref: 87316213



Q8094740
Piston Assy Turbo
Standard NEF Iveco
Engine Case New Holland
TSA T4000
OE Ref: 8094740

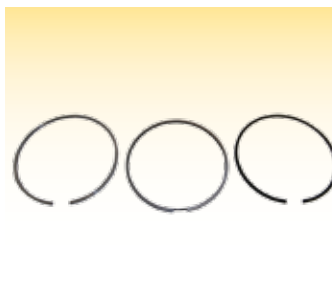

Q8094845
Ring Set Turbo Standard
NEF Iveco EngineCase
New Holland T4000
T5000 T6000 T9000
OE Ref: 8094845



Q87317252
Piston Assy Turbo
0.40mm NEF Iveco
EngineCase New Holland
T6000 C185 LT185 L185
OE Ref: 87317252

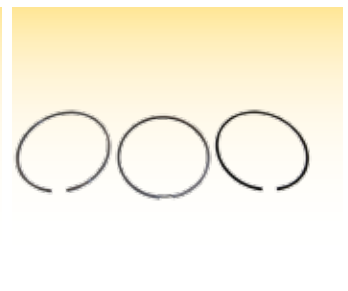

Q87316944
Ring Set Turbo 0.40mm
NEF Iveco EngineCase
New Holland T6000 C185
LT185 L185 LS185B
OE Ref: 87316944



Q2995787
Main Bearing Standard NEF
IvecoCase New Holland
T6000 T7000 C190 L190
OE Ref: 2995787



Q2995788
Main Bearing 0.254 NEF Iveco
EngineCase New Holland
T6000 T7000
OE Ref: 2995788



Q8093882
Rod Bearing Standard NEF
Iveco EngineCase New
Holland T4000 T5000 T6000
T7000
OE Ref: 8093882



Q8094960
Rod Bearing 0.254mm NEF
Iveco EngineCase New
Holland T4000 T5000 T6000
T7000
OE Ref: 8094960



Q2995784
Thrust Bearing Standard
NEF Iveco EngineCase
New Holland T6000
T7000
OE Ref: 2995784



Q2995785
Thrust Bearing 0.254mm
NEF Iveco EngineCase
New Holland T6000
T7000 TM7000
OE Ref: 2995785



Q4890832
Seal Front NEF Iveco
Engine Case NewHolland
T4000 T5000 T6000
T7000 LM
OE Ref: 4890832



Q4890833
Seal Rear NEF Iveco
Engine Case New Holland
OE Ref: 4890833



42968
Gasket Sub Kit NEF 6 Cylinder
T6000 T7000 TSA
OE Ref: RP704



42967
Gasket Sub Kit NEF 4 Cylinder
T6000 TSA
OE Ref: RP703



Q2852047
Gasket Water Pump O Ring
NEF T6000 T7000
OE Ref: 2852047



Q4899921
Gasket Intake NEF T6000 T7000
OE Ref: 4899921



Q2852885
Gasket Injection Pump NEF
TL80 TL90 TL100
OE Ref: 2852885



Q2852033
Gasket Valve Cover NEF TSA
T6000
OE Ref: 2852033 1478139 8780

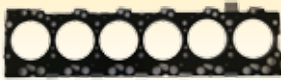

Q2830923
Gasket Cylinder Head
1.15mm 6 Cylinder NEF
TSA T6000 T7000
OE Ref: 2830923

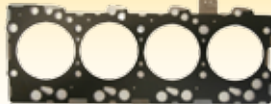

Q2830920
Gasket Cylinder Head
1.15mm 4 Cylinder NEF
TSA T6000
OE Ref: 2830920



Q4897877
Sump Gasket NEF
LM Telehandler
OE Ref: 4897877



Q2852012
Sump Gasket NEF
LM Telehandler
OE Ref: 2852012



Q4894301
Gasket Oil Pan 6 Cylinder
NEF TSA T6000 T7000
OE Ref: 4894301



Q4896409
Gasket Cooler
Element NEF
OE Ref: 4896409

MF 135 240 ENGINE OVERHAUL KITS



RELIANCE

63182 Engine Overhaul Kit 135 240

Part		OE Ref:	Qty	
1	2415343	Engine Oil Seal 135 Front - Timing Cover Seal** Kits 61398 61385 61476 61369 61372 61368	1447689M1	1
2	36883106	Crankshaft Packer 35X 135 148 165-203 Rear	81717827	1
3	82887	Sump Gasket Set (Rope Seal)	4222817M91	1
4	31358345H	Liner 35 135 148 203	1434175M1	3
5	2418F475	Lip Seal Perkins 3.152 - 6.354 Engine Block ** Kits 61371 61372 61373 61368 61751 **	1447691M91	1
6	61363	Piston Kit 135 240 - SET 3		1
7	82886	Head Gasket Set c/w Copper Gasket	4222480M91	1

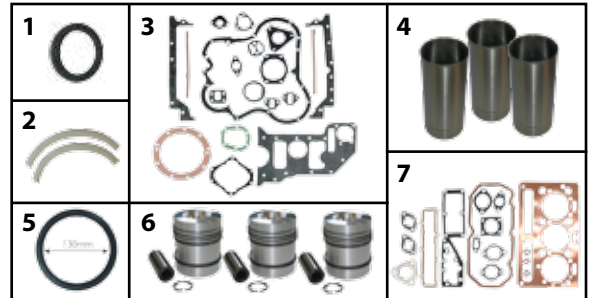

61368 Engine Overhaul Kit 135 240 + Oil Pump

Part		OE Ref:	Qty	
1	2415343	Engine Oil Seal 135 Front - Timing Cover Seal** Kits 61398 61385 61476 61369 61372 61368	1447689M1	1
2	36883106	Crankshaft Packer 35X 135 148 165-203 Rear	81717827	1
3	82887	Sump Gasket Set (Rope Seal)	4222817M91	1
4	31358345H	Liner 35 135 148 203	1434175M1	3
5	2418F475	Lip Seal Perkins 3.152 - 6.354 Engine Block ** Kits 61371 61372 61373 61368 61751 **	1447691M91	1
6	61363	Piston Kit 135 240 - SET 3		1
7	82886	Head Gasket Set c/w Copper Gasket	4222480M91	1
8	41314078	Oil Pump 35 135	736513M91	1

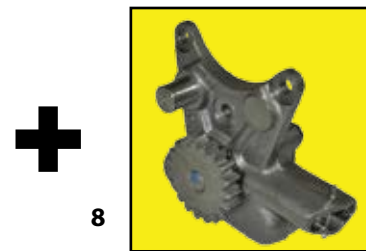
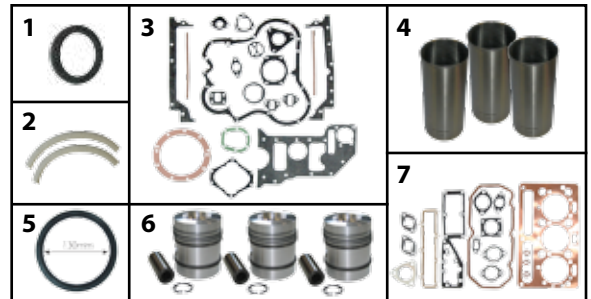

63185 Engine Overhaul Kit 135 240 + Oil Pump + Conrod Overhaul Kit + Valve Kit

Part		OE Ref:	Qty	
1	2415343	Engine Oil Seal 135 Front - Timing Cover Seal** Kits 61398 61385 61476 61369 61372 61368	1447689M1	1
2	36883106	Crankshaft Packer 35X 135 148 165-203 Rear	81717827	1
3	82887	Sump Gasket Set (Rope Seal)	4222817M91	1
4	31358345H	Liner 35 135 148 203	1434175M1	3
5	2418F475	Lip Seal Perkins 3.152 - 6.354 Engine Block ** Kits 61371 61372 61373 61368 61751 **	1447691M91	1
6	61363	Piston Kit 135 240 - SET 3		1
7	82886	Head Gasket Set c/w Copper Gasket	4222480M91	1
8	41314078	Oil Pump 35 135	736513M91	1
9	63183	Conrod Overhaul Kit 135 240		1
10	61827	Oil Pump 35 135 Valve Kit 135 3 Cylinder		1

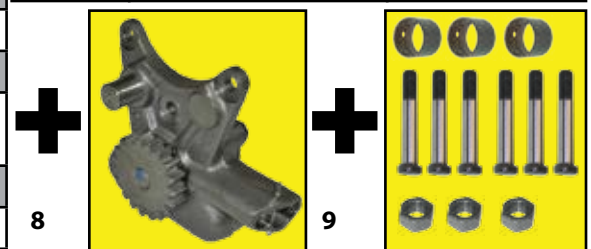
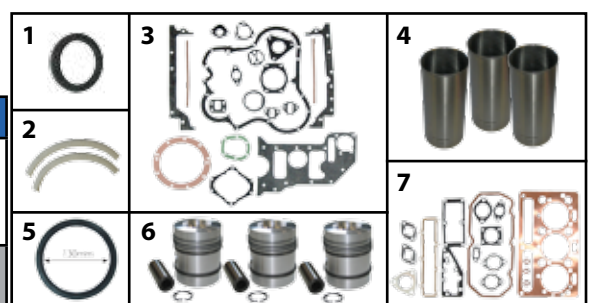

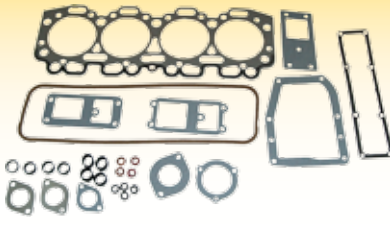

69048
Head Gasket Set A4.318 595 285 298
698 OE Ref: 4223502M91



U5LT0065
Head Gasket
Set 236 248
365 390 Flush
Liner
OE Ref:
4223005M91



1098
Head Gasket Set 20 TVO
OE Ref: 1883868M91



63032
Head Gasket Perkins 1104C 3445
3455 5445 5455 5460 6445 6455
6460 6470
OE Ref: 4225140M1



63029
Head Gasket Set Perkins 1104C 5435
5455 5460 6445 6455 6460 6470
OE Ref: 4225163M91



3563
Head Gasket Set 35 4 Cylinder
OE Ref: 1810028M91



63037
Head Gasket 6 Cylinder
5465 6465 6475 6480
7465 7475 7480
OE Ref: 4224955M1



63033
Rocker Cover Gasket
1104C3445 3455 5445
5455 5460 6445 6455
6460 6470
OE Ref: 4224954M1



0490491
Rocker Cover Gasket 35 35X
OE Ref: 731273M1



36862144
Exhaust Manifold Gasket 165 203
Eng



62673
Gasket Oil Filter Head 4245 4255 4265
4260 **Oil Filter Head Is 3773K004**
OE Ref: 3638774M1



36862131
Air Intake Manifold Gasket 212 248
OE Ref: 36862131



63034
Sump Gasket 1104C 3445
3455 5445 5455 5460
6445 6455 6460 6470
OE Ref: 4224957M1



63030
Sump Set Perkins
1104C-44 5435 5455
5460 6445 6455 6460
6470
OE Ref: 4225056M91



Quality Tractor Parts Ltd.

Est. 1981

Zone C, Mullingar Business Park, Mullingar, Co. Westmeath, Ireland. Ph: + 353 44 934 1638 Email: info@qtponline.com Web: qtponline.com

MASSEY FERGUSON

MAIN END BEARINGS

20D

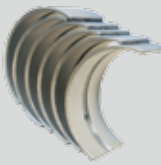

62379	Standard	E554320M91
62380	10 Thou	E554322M91
62381	20 Thou	E554323M91
62382	30 Thou	554324M91

BIG END BEARINGS

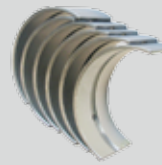

62383	Standard	554314M91
62384	10 Thou	554316M91
62385	20 Thou	554317M91
62386	30 Thou	1810086M91

TEF 20



63044	Standard	
63045	10 Thou	
63046	20 Thou	
63047	30 Thou	



63040	Standard	
63041	10 Thou	
63042	20 Thou	
63043	30 Thou	

35 135 (3.152)

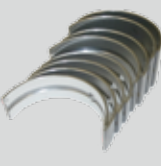

68084	Standard	58703
68084A	10 Thou	58703A
68084B	20 Thou	58703B
68084C	30 Thou	

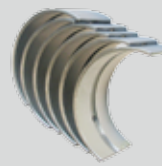

85036	Standard	737070M91
85036A	10 Thou	81803985
85036B	20 Thou	85036B
85036C	30 Thou	81803987

203



68082	Standard	68082
68082A	10 Thou	68082A
68082B	20 Thou	68082B
68082C	30 Thou	68082C



85035	Standard	4223582M1
85035A	10 Thou	85035A
85035B	20 Thou	85035B
85035C	30 Thou	85035C

212 236 248



81558	Standard	58703
81558A	10 Thou	58703A
81558B	20 Thou	58703B
81558C	30 Thou	

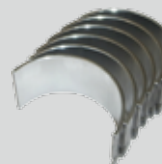

85042	Standard	3118135R1
85042A	10 Thou	85042A
85042B	20 Thou	85042B
85042C	30 Thou	85042C



63057
Thrust Washer Kit 20TVO
Standard 2 x Top & 2 x
Bottom Thrust Washers
OE Ref:825111M1



63058
Thrust Washer Kit 35
135 3.152 Standard 2 x
Top & 2 x Bottom Thrust
Washers
OE Ref: 31137551



31137212
Thrust Washer
35 135
Top C/S 7 Thou
OE Ref: 81717708



31137222
Thrust Washer
35 135 Bottom
7 Thou O/S
OE Ref: 31137222



Complete Engine - Massey Ferguson 135, 148, 240, 550 & all 3 Cylinder Applications

1000P

Engine 135 240 Original Type Complete with Electrics, Fuel Injection System Radiator, Cowl, Fan and Water Hoses

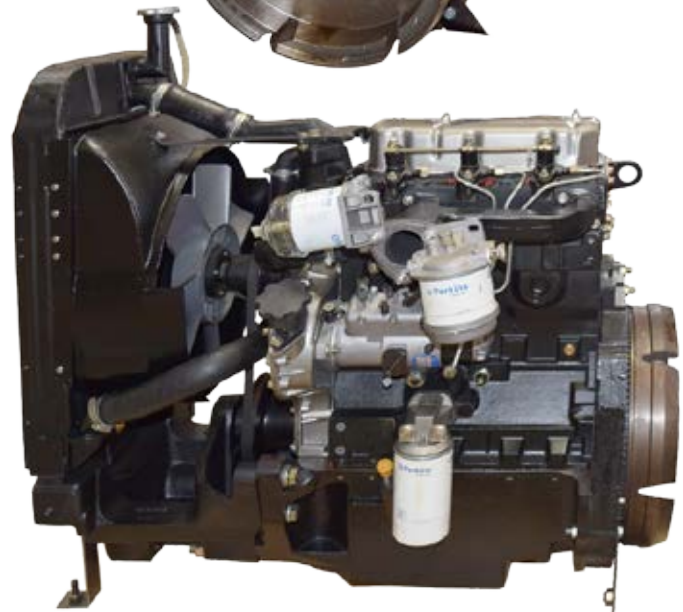
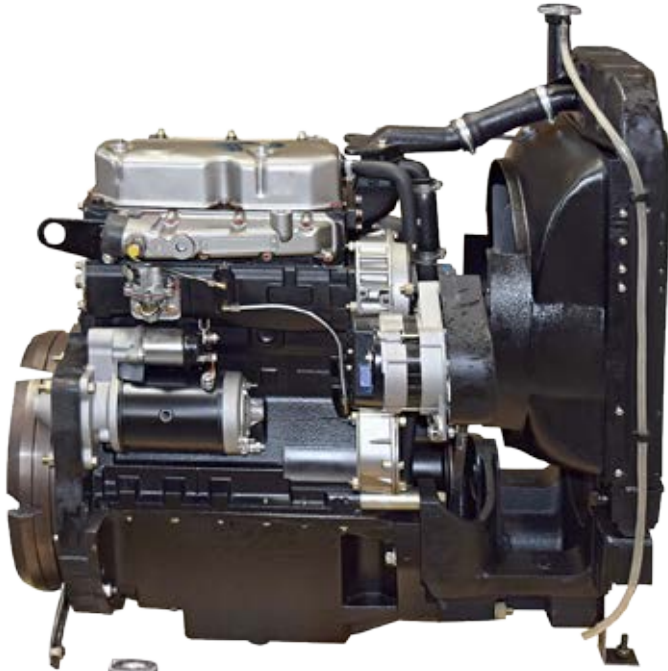

Related Products

62981



Cylinder Head
135 240

62982



Thermostat Bottom
Housing



CRANKSHAFTS MASSEY FERGUSON



63007
Crankshaft TEA20 Petrol TVO

63007K=
Kit which includes bearings



63008
Crankshaft TEF20 Diesel 4 Cylinder

63008K=
Kit which includes bearings



ZZ90084
Crankshaft 35 135 Rope Seal c/o
Bearings AD3.152 Keyway on Nose
** Key for Pulley is 36271704 **
OE Ref:3637454M91



94458
Crankshaft 135 240 Lip Seal c/o
Bearings AD3.152 Keyway on
NoseCrankshaft 135 240 Lip Seal c/o
BearingsOE Ref: 94458



62956
Crankshaft 65 MK2 165 MK1 c/o
Bearings 4 Cylinder Rope Seal
Perkins 203 Engine Keyed Nose **
62956K INCLUDES BEARINGS **
OE Ref: 742742M1

62956K =
Kit which includes bearings



63006
Crankshaft Rope Seal 168
175 188 A4.236 A4.248
OE Ref: ZZ90093

63006K =
Kit which includes bearings



94434
Crankshaft 236 248
LipSeal 1004 and 1004T
** Forged **
OE Ref: 94434

94434K 63009K =
Kit which includes bearings



63009
Crankshaft 4235 4245 4255 6130
6140 6150 3350
3355 4345 4355 6235 6245 6255
4265 4365 6265 1004.4T Blue
1004.40 Green 1004.40TW
OE Ref: ZZ90202

63009K =
Kit which includes bearings



63010
Crankshaft 5465 6465
6475 6480 7465 7475
7480 1106C - E60TA 6.354
Phaser
OE Ref:ZZ90213



Quality Tractor Parts Ltd.

Est. 1981

Zone C, Mullingar Business Park, Mullingar, Co. Westmeath, Ireland. Ph: + 353 44 934 1638 Email: info@qtponline.com Web: qtponline.com

CRANKSHAFTS

FORD



42893
Crankshaft Super Dexta 2000
3000 4.2" Stoke
OE Ref: E0NN6303AA



42894
Crankshaft Ford 4000 4600
4610 4.4" Stroke
OE Ref: 83998275



42895
Crankshaft 5000 5600 5610 6600
7000 7600 7700 7610 7710 78
Teeth Gear 4.2" Stroke
OE Ref: 81804029



42897
Crankshaft Ford 6600
6700 7600 7700 7610
5600 5610 7710 78 Teeth
Gear 4.4" Stroke
OE Ref: E5NN6303FA



42896
Crankshaft 5610 6610
6710 7410 7610 7710 76
Teeth Gear 4.4" stroke
OE Ref:83998218

JOHN DEERE

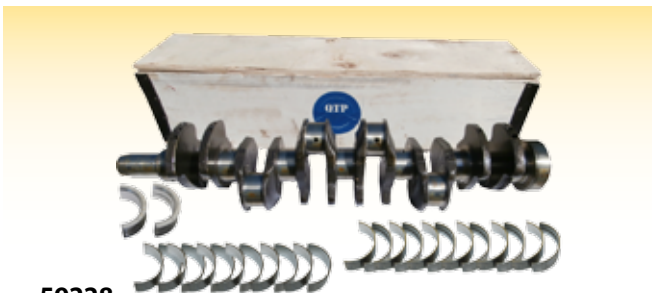

59228
Crankshaft John Deere 6 Cyl Taper Nose
6510 6910 6520 6920 6530 6930 7430 7530
OE Ref: RE505921

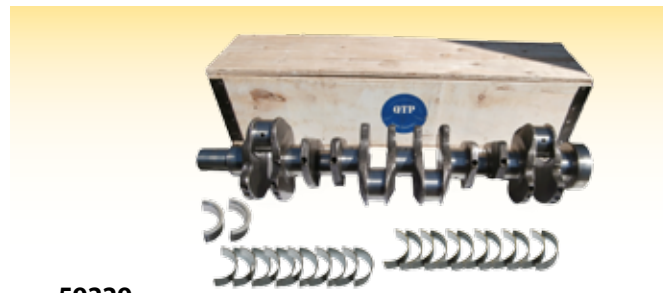

59229
Crankshaft John Deere 6 Cyl Straight
Nose 6510 6910 6520 6920 6530 6930
OE Ref: RE515785

CASE



52180
Crankshaft IHC 554 584
624 654 595XL 733 740
c/o Balancer Gear Ring
OE Ref: 3132968R93



Est. 1981

Quality Tractor Parts Ltd.

Zone C, Mullingar Business Park, Mullingar, Co. Westmeath, Ireland. Ph: + 353 44 934 1638 Email: info@qtponline.com Web: qtponline.com

DEUTZ



53172
Cylinder Kit
Deutz FL912 3
Ring ** 4 Ring
59346 **
OE Ref:
02928882



53337
Cylinder
Kit Deutz
FL913
3 Ring
102mm



53169
Cylinder Head
Deutz FL912 FL913
OE Ref: K2232570



53170
Head Gasket Set Deutz
FL912 FL913 ** Head
Gasket is 53341 **
OE Ref: K928994



53171
Gasket Set Deutz FL912
4 Cylinder
OE Ref: 02928974



53338
Gasket Kit Deutz 913



51317
Oil Pump Deutz FL912OE
Ref: 2130440



53332
Starter Deutz 912 3 bolt
9 teeth
OE Ref: 4283173



53335
Cylinder Kit Deutz 1013
OE Ref: UH259101



53334
Gasket Set Deutz
1013 4 Cylinder
OE Ref: 2929666



53333
Gasket Set Deutz 1013 6
Cylinder
OE Ref: 2929665



53331
Water Pump Deutz 1013
OE Ref: 4283173



53330
Oil Pump Deutz 1013 4
Cylinder
OE Ref: 4289740



53329
Oil Pump Deutz 1013 6
Cylinder
OE Ref: 4289742



53328
Injector Pump Deutz
1013
OE Ref: 2111335



Est. 1981

Quality Tractor Parts Ltd.

Zone C, Mullingar Business Park, Mullingar, Co. Westmeath, Ireland. Ph: + 353 44 934 1638 Email: info@qtponline.com Web: qtponline.com

RENAULT



59154
Engine Complete 4045D 350
Series Powertech
OE Ref: 4045D
55.5kw 75HP

RENAULT:

CERES 325 335
CELTIS 426
CERGOS 335

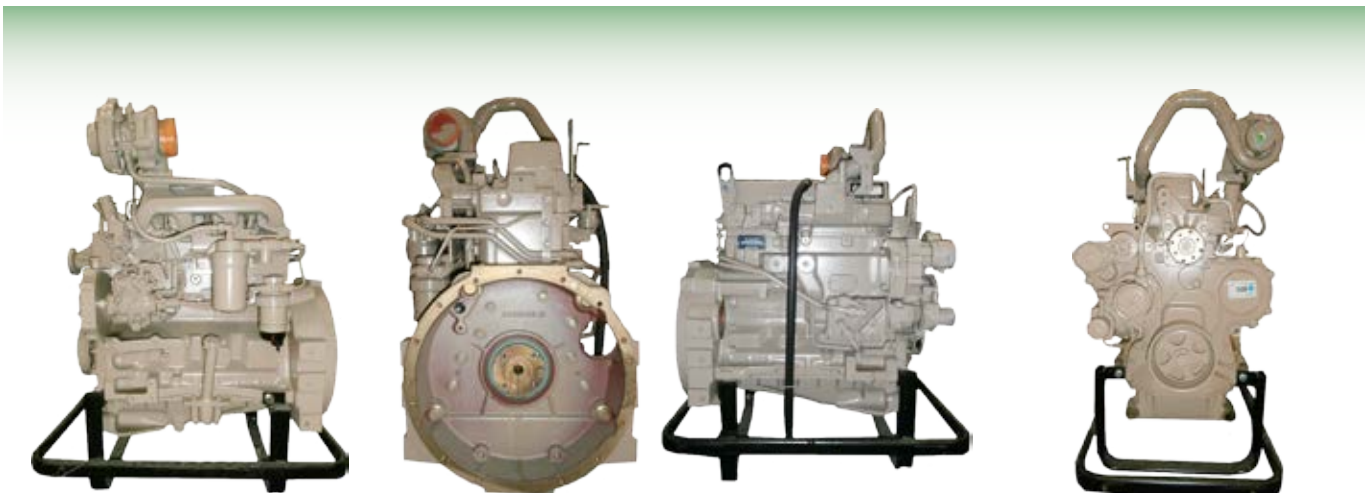

59152
Engine Complete 4045T
High Horse Power 350 Series
OE Ref: 4045T High Horsepower
67kw 91HP

RENAULT:

ARES 547
CERES 355
CELTIS 446
CERGOS 355