

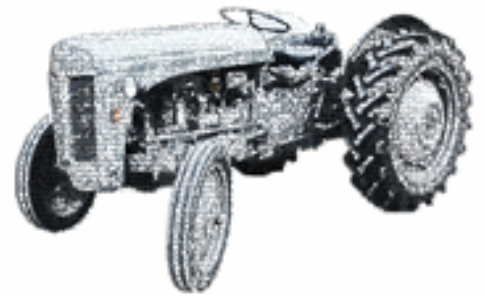

L.O.G Heigl



Accessories Catalogue

Contents

Cab, Sheet Metal

& Electrical Msc 3

Door Handles Msc 3

Wiper Parts Msc 8

Mirrors Msc 15

Seats Msc 20

Gas Struts Msc 30

Lucas Beacons Msc 40

Work Lamps Msc 42

Trailer Lights Msc 46

Easyfit Wiring Msc 48

Marker Lamps Msc 50

LED Trailer Lights Msc 52

Pins & Sockets Msc 54

Trailer Jockey

Wheels & Parts Msc 56

Trailer Heads Msc 57

Tow Hitches Msc 58

Nuts & Bolts Msc 61

Suspension Msc 62

Mudguards Msc 63

Brake Shoes Msc 65

Brake Cables Msc 66

Bulbs Msc 70

Electrical Cable Msc 72

Terminals/Fuses Msc 74

Batteries & Accessories Msc 78

Relays Msc 82

Switches Msc 83

Fan Blowers Msc 87

Tractor Paint Msc 90



Brakes, Linkage & Hydraulics

Msc 92

Euro Brackets Msc 92

Top Links Msc 93

Top Link Components Msc 101

Stabilisers Msc 104

Clevis Components Msc 116

Linkage CBM Type Msc 118

Hydraulic Pumps Msc 130

Quick Release Couplings Msc 132



Cooling

Msc 141

Radiator, Fuel & Oil Caps Msc 141

Fuel Pumps Msc 146

Fan Belts Msc 147



Axle Parts

Msc 153

Orbital Units Msc 153



Bolts, Nuts & Bearings Msc 154

High Tensile Steel Bolts Msc 154

Ball Bearings Msc 160



Garage Equipment

Msc 163





Universal Joints, PTO & Crossends

Msc 180

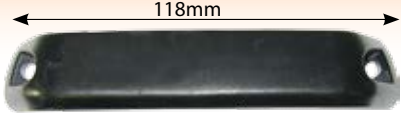
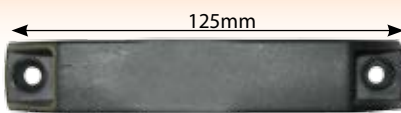

Cab Parts

Interior Door Handles

<p>4320</p>  <p>118mm</p> <p>Door Handle Interior</p>	<p>4322</p>  <p>125mm</p> <p>Door Handle Interior</p>	<p>4323</p>  <p>154mm</p> <p>Door Handle Interior Large</p>
---	--	---

<p>4571</p>  <p>Door Handle Inside Tap On</p>	<p>4572</p>  <p>Door Handle - Inside Allen Key</p>
---	--

Door Handles

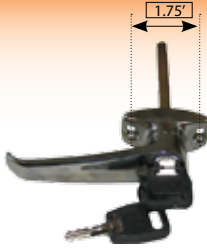
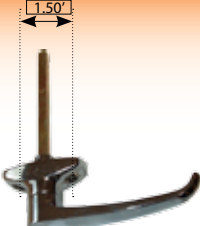
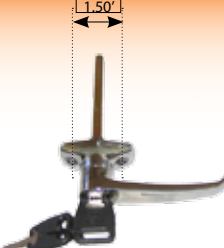
<p>3982</p>  <p>1.75"</p> <p>Non Locking Plain Handle 1.75'</p>	<p>3983</p>  <p>1.75"</p> <p>Locking Handle 500's 1.75'</p>	<p>1770</p>  <p>1.50"</p> <p>Door Handle Non Locking (1.5')</p>	<p>1288</p>  <p>1.50"</p> <p>Door Locking Handle (1.5')</p>
--	--	---	--

<p>4246</p>  <p>Door Handle 290 Sanki Outer</p>	<p>429983</p>  <p>Door Handle 4200 Outer LH & RH</p>	<p>4567</p>  <p>Door Handle 300's Outside ** Spacer pack is 62842 **</p>	<p>62842</p>  <p>Spacer Pack 390 Door Handle ** Door Handle is 4567 **</p>
---	--	---	--

<p>4317</p>  <p>Door Handle & Lock Ford Super Q Cab Outside</p>	<p>6097</p>  <p>Door Handle 600 Outer LH & RH</p>	<p>61266</p>  <p>Door Handle 5400 6100 6200 8100 8200</p>
---	--	---

Cab Door Handles

Ford

42025



Door Handle Outer Ford 40 Series
Suits TL & TS 60

42095



Door Handle Ford TSA MXU

3058



Door Locking Handle Ford
Q Cab

Fiat

7258

Door Handle Fiat RH Outer 1180 1280
1380 1580 1880 580 680 780 880 880-5
980 55-90 60-90 65-90 70-90 80-90



7259

Door Handle Fiat LH Outer 1180 1280
1380 1580 1880 580 680 780 880 880-
880-5 980 55-90 60-90 65-90 70-90
80-90



David Brown

2341



Door Handle David Brown
Q Cab LH

2342



Door Handle David Brown
Q Cab RH

Zetor

5073



Door Handle Zetor 8011
Inside

5129



Door Handle Zetor 8111 LH
& RH Outer

John Deere

59455



Outer Door Handle John
Deere 61 6900 LH & RH

59451



Push Pull Inner Door Han-
dle John Deere LH
6000 10 20 30 Series

59362



Rubber Door Handle John Deere
Outer 6000 7000
** Up to serial no. 203054 **

4652



Door Handle Duncan
Outside

C3001



Door Handle Cab Craft LH
RH Inner

C3002



Door Handle Cab
Craft Outer

2343



Rubber Door Stopper
Female

2344



Rubber Door Holder
- Male

62791



Grill Mounting Rubber 5400
6400 7400 8200

51252



Door Retainer Nylon
Heavy Duty

Cab Door Handles

<p>3190</p> <p>Hinge Female / Male Bushed Lift Off RH</p>	<p>3189</p> <p>Hinge Female / Male Bushed Lift Off LH</p>	<p>3186</p> <p>Hinge Female Lift Off</p>	
<p>3188</p> <p>Hinge Male Bushed Lift Off RH</p>	<p>3187</p> <p>Hinge Male Bushed Lift Off LH</p>	<p>3184</p> <p>Hinge Male Lift Off LH</p>	<p>3185</p> <p>Hinge Male Lift Off RH</p>
<p>3779</p> <p>Hinge 6" x 1 1/2" x 5/16" Straight</p>	<p>4513</p> <p>120mm Mild Steel Weld on Hinge & Nipple</p>	<p>1100</p> <p>Hinge Carrier 1/2" Weld on</p>	<p>4512</p> <p>100mm Mild Steel Weld on Hinge</p>

Door Slam Locks

<p>1655</p> <p>Door Slam Lock LH</p>	<p>1718</p> <p>Door Slam Lock Cab RH</p>	<p>1769</p> <p>Door Slam Lock LH</p>	<p>1768</p> <p>Door Slam Lock RH</p>
---	---	---	---

David Brown

<p>1771</p> <p>Door Slam Lock Duncan</p>	<p>S4040</p> <p>Door Slam Lock Ford 2000 2600 3000 3600 4000 4100 4600 5000 5600 6600 7000 7600(3058 outer/4571 inner)</p>	<p>2213</p> <p>Door Slam Lock David Brown LH No Safety Catch</p>	<p>2212</p> <p>Door Slam Lock David Brown RH No Safety Catch</p>
---	---	---	---

Door Locks

1670819



Door Lock 590 LH

1670820



Door Lock 590 RH

3191



Door Lock RH for Cab

3202



Door Lock LH for Cab

3301855



Door Lock 600 RH Inner

6098



Door Lock 600 Inner LH

3718



Door Lock Q Cab RH /
Sankey RH

3719



Door Lock Q Cab LH /
Sankey LH

Ford

42106

Door Lock Ford TM TL
TS TLA - LH



41338

Door Cable Ford TL TM TS



42146



Door Lock Ford T TSA
LH

4315



Door Lock Ford Super
Q Cab LH Inner

4316



Door Lock Ford Super
Q Cab RH Inner

Fiat

7256

Door
Lock Fiat
RH Inner



7257

Door
Lock Fiat
LH Inner



John Deere

59914

Door Lock John Deere - 00
Series Only LH
** Up to serial no. 203054
**



Blizzard

6362

Door Lock Landini Bliz-
zard LH



6363

Door Lock for Landini
Blizzard RH



6373

Gasket Blizzard Door
Lock

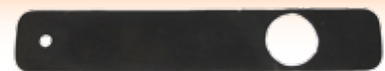

1028

Door Lock Striking
Piece



6698

Door Lock 3000 RH



6699

Door Lock 3000 LH



2798

Window Handle



4507

Glazing Clamp



3787

Side Window
Handle Kit (Ratchet
Positioned)



Cab Parts

Alarms

Yellow Wire to Disable Alarm When Lights are turned on..

51083



Reversing Alarm Buzzer 12v - 24v

51986



Reversing Alarm Buzzer Waterproof 12v 24v

51179



Reversing Alarm Buzzer Waterproof 12 24v

Buzzers

51005



Buzzer 6-24 Volt

1956

Buzzer 12v Mini



Bonnet Catches

2580



Bonnet Catch 5" -

2581



Bonnet Catch 2 1/2"

Wheel Spinners

1197



Wheel Spinner Straight - Flat Steering Wheel

1148



Wheel Spinner 15°

4029



Wheel Spinner 30°

Disc Holder

1772



Tax Disc and Licence Holder Chrome

Cable

4885

Cable C/O Lever & Valve



Wiper Motors

2494

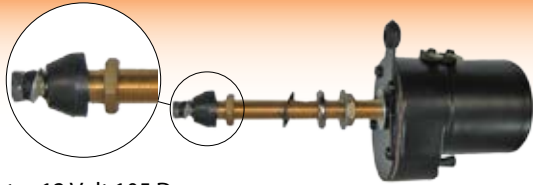

Wiper Motor 12 Volt 105 Degrees
Small Tapered

2493



Wiper Motor 12 Volt 85 Degrees
Small Tapered

41656

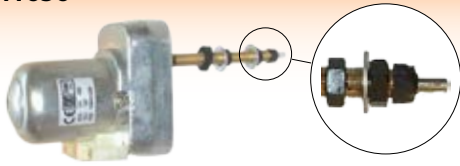

Wiper Motor 12 Volt 120;
Straight Single Spin
Shaft Length 99mm

51045

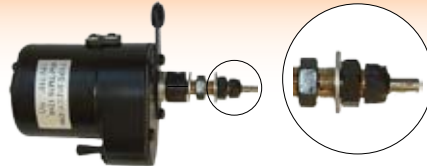

Wiper Motor 12 Volt 110; Short Stem
Straight Shaft Length 46mm
Arm ref is 4296

2491

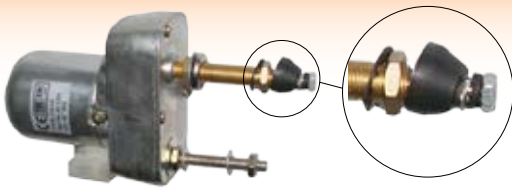

Wiper Motor 12 Volt 80; Small Tapered Shaft
Shaft Length 58mm - Check Type of Cab

2492

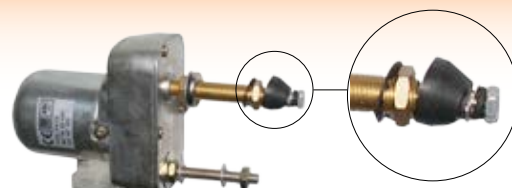

Wiper Motor 12 Volt 110; Small Tapered Shaft
Shaft Length 58mm

51025

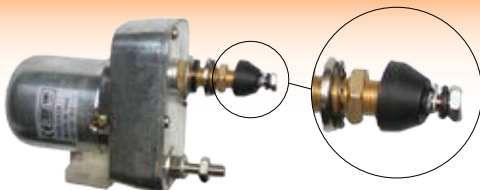

Wiper Motor Case 12V 135; Small Tapered Shaft
Shaft Length 34mm

51026

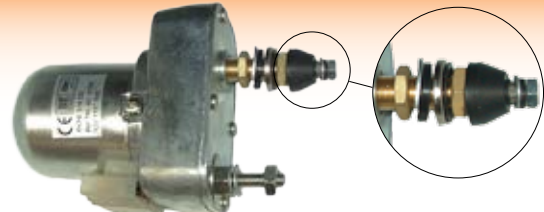

Wiper Motor Case 12V 115; Small Tapered Shaft
Shaft Length 34mm

51260



Wiper Motor 12 Volt 90;
Small Tapered Shaft
Wiper Motor With Cover &
Switch - Shaft 48mm

51006

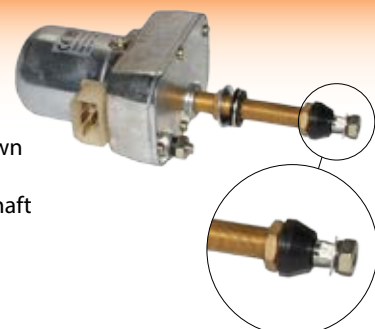

Wiper Motor David Brown
12V 95;
Large Tapered Shaft - Shaft
Length 80mm

Wiper Motors

1008

Kit = 4169



Wiper Motor 12 Volt 110 Degrees Small Tapered c/w Switch - Shaft Length 58mm

3859

Kit = 4195



Wiper Motor 12 Volt 90; Small Tapered Shaft c/w Switch Used in kit 4195 (Shaft length 58mm)

3860



Wiper Motor 24 Volt 90; Small Tapered Shaft c/w Switch - Shaft length 58mm

4169



Wiper Motor Kit 12 Volt 110; c/w Arm & Blade Shaft Length 58mm

4195

Motor = 3859



Wiper Motor Kit 12 Volt 90; c/w Arm & Blade Shaft Length 58mm

6671



Wiper Motor 300 12V 115; Small Tapered Shaft (Shaft length 78mm)

6645

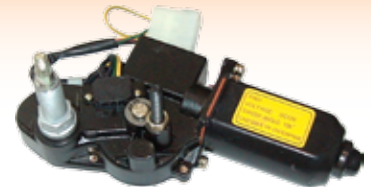

Wiper Motor 390 12V 105; Large Tapered Shaft Shaft length 33mm

63240



Wiper Motor Front 54s 42s 43s

1563



Wiper Motor Ford Super Q TW5 TW35 10

59283



Wiper Motor John Deere 6000

51027



Wiper Motor John Deere SG2 12V 90;

51061

Arm = 2207
Blade = 1619



Wiper Motor 5400 6100 6200 6400 7400 8100 Also Fits 8200 - For Rear Window

51059

Arm = 2207
Blade = 1619



Wiper Motor 390 398 105; Shaft Length 48mm

63268

Wiper Motor John Deere SG2 12V 90;



Window Washer Parts

51619

Window Washer Tank 12V
Double 4 Ltr

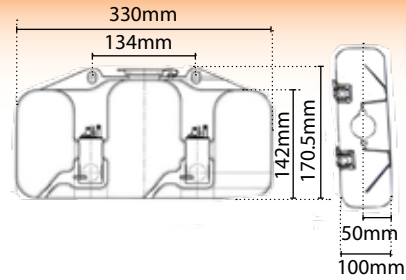

51080

Window Washer 2.2
Ltr 12V

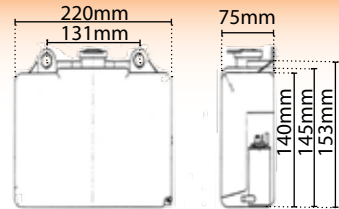

51607

Window Washer
12V

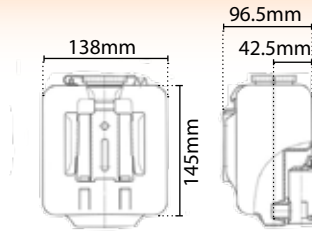

51079

Window Washer Kit



51078

Window Washer T
Piece 4 x 6mm





Date:.....

No. of Pages:.....

Name of the Rep.....

A/C Number:.....

From:.....

e-mail.....

Phone No.:.....

Fax No.:.....

Please quote for the following parts - Quotation Number :

I wish to confirm the following order on Quotation Number:

Please supply the following parts:

Qty	Part No.	Description	Unit Price
1.			
2.			
3.			
4.			
5.			
6.			
7.			
8.			
9.			
10.			
11.			
12.			
13.			
14.			
15.			
16.			
17.			
18.			
19.			
20.			
21.			
22.			
23.			
24.			

Please photocopy this page

Please do not remove this page

Comments:

Customer Signature: **Rep's Signature:**

Tel No: + 353 44 934 1638















e-mail: info@qtponline.com, www.qtponline.com

Page of

Wiper Arms

Photo	Part No	Motor Type	Description	Length	
				Inches	mm
	4296	Straight Shaft	Wiper Arm	18"	457.2
	2014	Straight Shaft	Parallel Arm	18"	457.2
	2207	Small Tapered Shaft	Wiper Arm	12½"	315
	1897	Small Tapered Shaft	Parallel Arm Blade=1619 Blade=53769	19½"	500
	51497	Small Tapered	Wiper Arm	15½"	400
	51008	Large Tapered	Wiper Arm MF 600's	19½"	500
	2870	Large Splined	Wiper Arm Ford Super Q & Q Cab Blade=2837	17"	431.8
	4894	Large Tapered	Wiper Arm Large Hole	15½"	400

Wiper Blades

Photo	Part No	Description	Length	
			Inches	mm
	2206	New 1008 Motor		400
	2246	Wiper Blade	17½"	450
	4685	Wiper Blade	24"	609.6
	1619	Suits 1897 Wiper Arm	20"	508
	6753	Suits 600/3000'S		600
	61941	42/43/61/62/81/82's ALSO 5400 6400 7400 Case Ford DB Fiat Deutz JD Leyland	20"	508
	2837	Ford Q & Super Q Cab John Deere 50's SG2 Cab Wiper Arm =2870		500
	404895	Ford 40 TS TM M		550
	51009	Case XL		650
	62039	Wiper Blade Front J.Deere 6000/10/20 Front and Rear for 50HX	23½"	600
	59803	Wiper Blade Rear John Deere 6000/10/20		
	780048	Wiper Blade Renault TS/TX		
	62283	Wiper Blade	28"	700
	53769	Wiper Blade suits 1897		

Cab Parts

Extractor Fans

4877

Extractor Fan C/O Switch



61184

Knob for Tractor Cab Heater



4879

Shut off Valve 16mm



1975

Heater Plug Pipe 3/16 Male



Heater Hoses

6009

Hose Heater 300 Top -
Up to Series

6617

Heater Hose
Connection 300's

6008

Hose Heater 300
Bottom

6469

Hose Heater 300 Top - From
Series

6617

3 Heater Hose
Connection 300'S

6484

Hose Heater
300 Bottom

6008

Hose Heater 300
Bottom



6469

Hose Heater 300 Top - From
Series



6488

Hose Heater 300



4529

Hose Heater 5/8" - Per Mtr

2467

Hose Heater 1/2" Per Mtr

51886

Hose Heater 3/4" - sold by
the metre



Complete Mirrors

Massey Ferguson

62615



Mirror Complete
Telescopic 5400 6400
LH RH

Glass=41101GL
313mm x 224mm

1506



Mirror 3000s (320 x
220mm)

62086



Mirror Round c/w
Arm To Suit Exhaust
Pipe

6499000



MIRROR COMPLETE
600 RH (235x170mm)

6499001



Mirror Complete 600 LH
(235x170mm)

62103



Mirror Round R-View
& Clamp kit For Ex-
haust P

59656

Mirror Rear View 180;
Wide Angle Small
(220x110mm)



59657

Mirror Rear View 180;
Wide Angle Large
(280X160mm)



Same

6490000

Mirror Complete Same Deutz RH
(180X236mm)



1190

Mirror 340 x 220mm



6490001

Mirror Complete Same Deutz LH
(180X236mm)

4704

Mirror Mercedes
368 x 182



1584

Mirror 420mm x
200mm Mercedes



1241



Mirror For Interior - 147mm x 97mm
Super Q

1535



Mirror 14" x 6 1/2" Flat

6491001



Mirror Complete
Same LH

Complete Mirrors

Ford

2042

Mirror Ford 7840 Convex 10 1/2" x 6 3/4" Also suits Q Cab
Glass=2042GL
(257x157mm)



1191

Mirror Assembly Ford 40s
(218x173 mm)



41101

Mirror Ford 60/70/M/TM/TR/TS's
Rear View
Glass=41101GL
Mirror Arm =42098



41102

Mirror Ford 8160-8970 M TM TR
TS Rear View
Glass=2042GL
Mirror Arms To Suit:
409679 + 409680



409690



Mirror Ford 40 TS 81-85 60 Rear
View LH
Mirror to Suit 409928

409691



Mirror Ford 40 TS 81-85 60 Rear
View RH
Mirror to Suit 409928
Glass= 2042GL

409928



Mirror Ford 40 TS 81 - 8560 Rear
View
Suits 409691 & 409690
Glass= 2042GL

Smat Nord Mirror

6480025

Mirror 237 x 180 16mm 18mm 20mm Clamps
Ford 7840 Convex Suits Q Cab
Fiat Deutz Same Lamborgini Massey Ferguson



6854001

Mirror Complete
Fiat Hitachi
(180x236mm)



6451000

Mirror Complete
Fiat RH
(180x236mm)



6451001

Mirror Complete
Fiat LH
(180x236mm)



Complete Mirrors

John Deere

59901

Mirror John Deere
10 20 6000 Rear
View
Glass=59901GL



53154

Mirror Head
295 x 215



6398025

Mirror John
Deere Replace-
ment



4238

Mirror 13 1/2 x 7
1/2'
Glass=4238GL



2325

Mirror Ford Q Cab 10
1/2 x 6 3/4
Glass=2325GL



1254

Mirror Head 7'
x 5'
Glass=1254GL



6399000

Mirror Complete RH
(225x312mm)



6551001

Mirror Assembly Com-
plete - 215mm



53155

Mirror Kit Heated with Electrical
Adjustment and Cables c/w Mirror
Control MF/ CNH

Mirror Size - 305x215mm

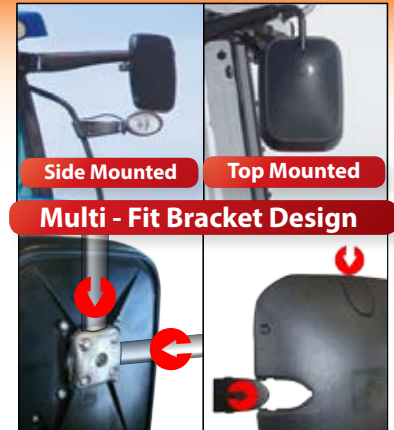

6399001

Mirror Complete LH
(225x312mm)

Mirror Only - 53748

Mirror Glass

4238GL



Glass for 4238
Replacement

2325GL



Mirror Glass Ford Q Cab
for 2325 253 x 150 mm **
2042GL is Convex **

1254GL



Mirror Glass 7" x 5" - 178
x 127mm

59690



Mirror Glass Deutz
Steyr Fendt 700 800
900's Size 300 x 214
Convex ** Single ** (5
per box

1192GL



1192GL
Mirror Glass for 1192
(374 x 190mm)

41101GL



Glass Replacement for 41101 tm Massey
Ferguson 54/64/62 series ** Suits 62615
Mirror ** 313mm x 224mm

2042GL



Mirror Glass Convex for 2042
Ford 40's

59901GL



Mirror Glass John Deere 10 20 60 R/
View PAIR
281 x 201 mm

Ford



409616

Mirror Ford TM115-165 LH Telescopic
Rear View (99-02) 8160-8560 (95-00)
TS90-115 (97-03)
Mirror = 41101



409617

Mirror Ford TM115-165 RH Telescopic
Rear View (99-02) 8160-8560 (95-00)
TS90-115 (97-03)
Mirror = 41101



409679

Mirror Arm Ford 60 TM TS LH
Mirror = 41102



409680

Mirror Arm Ford 60 TM TS RH
Mirror = 41102



42098

Mirror Arm TSA T Series RH
Mirror = 41101 Glass 41101GL



42099

Mirror Arm TSA T Series LH
Mirror = 41101 Glass 41101GL



6550

Mirror Arm 300 LH & RH D
Headed



4395

Mirror Arm Ford Super Q 13' Throw Out
Top to Bottom 30" Throw out 13"



62838

Mirror Arm RH 41
42 61 81



62839

Mirror Arm LH 41
42 61 81

Mirror Arms

2590 Mirror Arm 8"

2589 Mirror Arm 12"

2591 Mirror Arm 16"



John Deere

59796



Mirror Arm John Deere 10 20
6000's LH Telescopic

59800



Mirror Arm John Deere 10 20
6000's RH Telescopic

59797

Mirror Arm Kit John Deere
6000 LH Telescopic
Mirror = 59901
Arm = 59796



59903

Mirror Arm Kit John Deere
6000 RH Telescopic
Mirror = 59901
Arm = 59800

Renault

780066

Mirror Arm Renault TS-TX LH



780067

Mirror Arm Renault TS-TX RH



SEATS FOR MODERN TRACTORS

51803

Seat Foldable Armrest Scissor Suspension Black hard wearing cloth fabric

- Fore Aft Slide Adjustment
- Adjustable weight from 50kg - 136kg

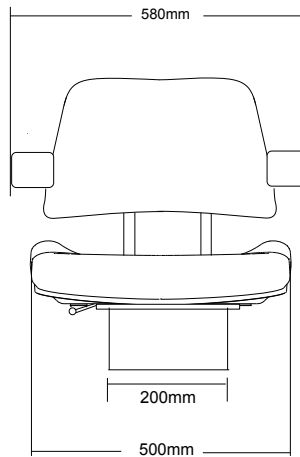

53757
Arm Rest Suits 51803

51804

Seat with Air Suspension and Foldable Armrests Cloth Upholstered



43683

Air Valve Switch for Height Adjustment In Arm Rest

Fits All Seats That Have Height/Weight Adjustment In Arm Rest



51874

BLUE SEAT WITH ANGLE ADJUSTMENT



52845 SCISSOR SUSPENSION SEAT

Seat Foldable Armrest Scissor Suspension Black 390 290

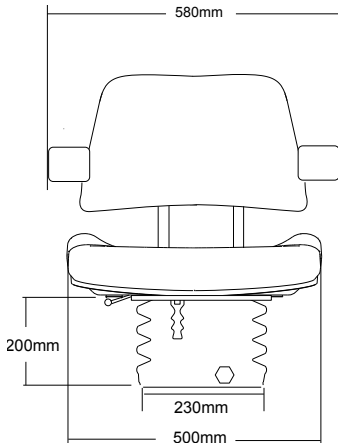

Base 230mm Wide
330mm Deep

2195

**RIGHT HAND SIDE
ARM REST FOR
GRAMMER SEAT -**
Landini, John Deere,
Massey Ferguson



51606 BLUE SEAT WITH ANGLE ADJUSTMENT

51738 BLACK SEAT WITH ANGLE ADJUSTMENT

- Heavy duty vinyl covered molded cushions
- Adjustable weight suspension from 50kg - 136kg
- Height Adjustment
- Fore Aft Slide Adjustment
- Heavy steel base with multiple hole mounting pattern



51737 BLACK SEAT WITH SLIDING BASE

51805 BLUE SEAT WITH SLIDING BASE

- Heavy duty vinyl covered molded cushions
- Adjustable weight suspension from 50kg - 136kg
- Height Adjustment
- Fore Aft Slide Adjustment
- Heavy steel base with multiple hole mounting pattern



53850 SEAT BLACK

- Heavy duty vinyl covered molded cushions
- Flat Back
- Sliding Base

53852 Replacement Back Cushion



62957 Seat Riser Massey Ferguson 35 135



53851 Replacement Base Cushion

53764

MECHANICAL SEAT WITH COMPACT BASE



- 1 Double depth comfort Fabriform® cushions for that legendary Sears comfort
- 2 Fold up arm rests with substantial foam padding improving comfort
- 3 Weight adjustment indicator
- 4 Weight adjust control
- 5 Height adjust control
- 6 Fore/aft slide control
- 7 Mechanical suspension

908 , Sears seat part No. [SA20459.400](#)

SPECIFICATIONS

Double depth Fabriform® comfort cushions

Weight adjustment 30-130kg

Height adjustment 80mm

Slide travel 160mm

Moulded suspension cover

Vibration performance to ISO 7096

Armrests with tilt up adjustment

Operator presence switch

Supplied with multifix mounting kit

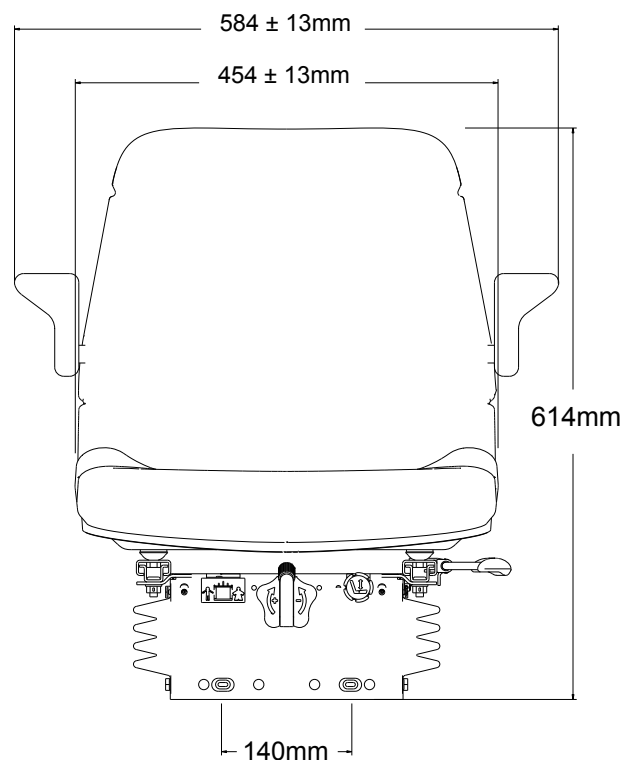

53765 AIR SEAT WITH COMPACT BASE



- 1 Double depth comfort Fabriform® cushions for that legendary Sears comfort
- 2 Fold up arm rests with substantial foam padding improving comfort
- 3 Height adjustment indicator
- 4 Low natural frequency Airide® suspension -air valve Adjust switch
- 5 Height/weight adjust control
- 6 Fore/aft slide control

930 , Sears seat part No. [SA20442.400](#)

53883
Compressor Service Kit
12V Suits 53765 53766
53767

53884
Air Spring Service Kit
Suits 53765 53766
53767



SPECIFICATIONS

Double depth Fabriform® comfort cushions

Weight adjustment 30-130kg

Height adjustment 80mm

Slide travel 160mm

Moulded suspension cover

Vibration performance to ISO 7096

Armrests with tilt up adjustment

Operator presence switch

Supplied with multifix mounting kit

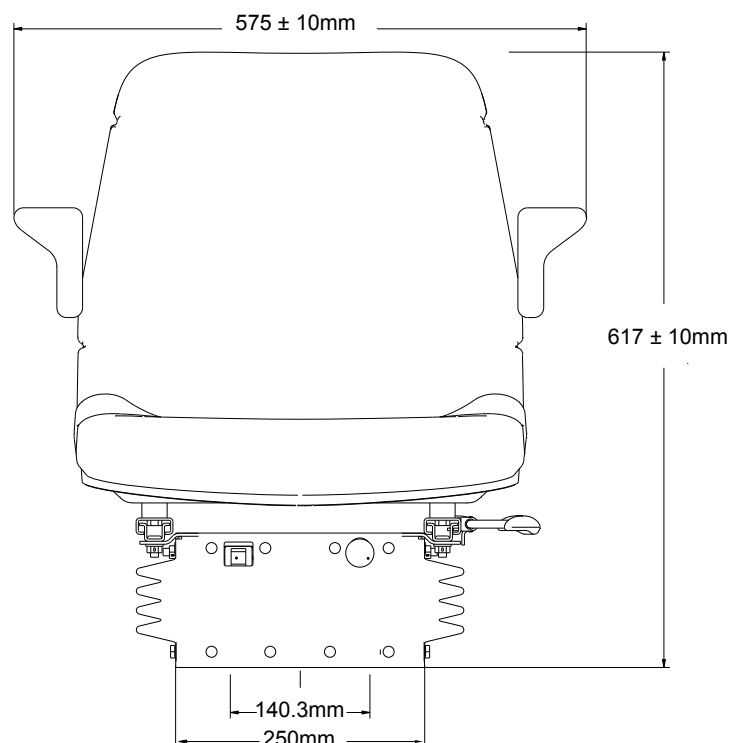



- 1 Ergonomically sculptured back support for full range of movement
- 2 Double depth comfort Fabriform® cushions for that legendary Sears comfort
- 3 Low natural frequency Airide® suspension -air valve adjust switch
- 4 Slide adjust control switch
- 5 Swivel 24° rotational adjustment left and right with lock in, lock out, free swivel facility. Making it easier when driving, getting in and out of the seat or using a rear attachment
- 6 Horizontal isolator for reduction in vibration when traveling at speed or when towing implements
- 7 Adjustable backrest angle provides customised comfort preventing damage from bad posture.
- 8 Fold up arm rests with height adjustment featuring substantial foam padding improving comfort when turning in the seat
- 9 Lumbar support lever

3045 , Sears seat part No. [SA24117.400](#)

53883 Compressor Service Kit 12V	53884 Air Spring Service Kit
53928 Operator Presence Switch Service Kit	

SPECIFICATIONS

- Replaceable double depth Fabriform® comfort cushions
- Height adjustment 76mm
- Back angle fully adjustable
- Automatic height & weight adjustment 50 -150kg
- Automatic ride protection system(ARPS™)
- Suspension stroke 80mm
- Horizontal isolator fully integrated, sprung & Duo® Damped
- Armrests with height & tilt up adjustment
- Slide travel 160mm
- Moulded suspension cover
- Vibration performance to ISO 7096
- Supplied with multifix mounting kit

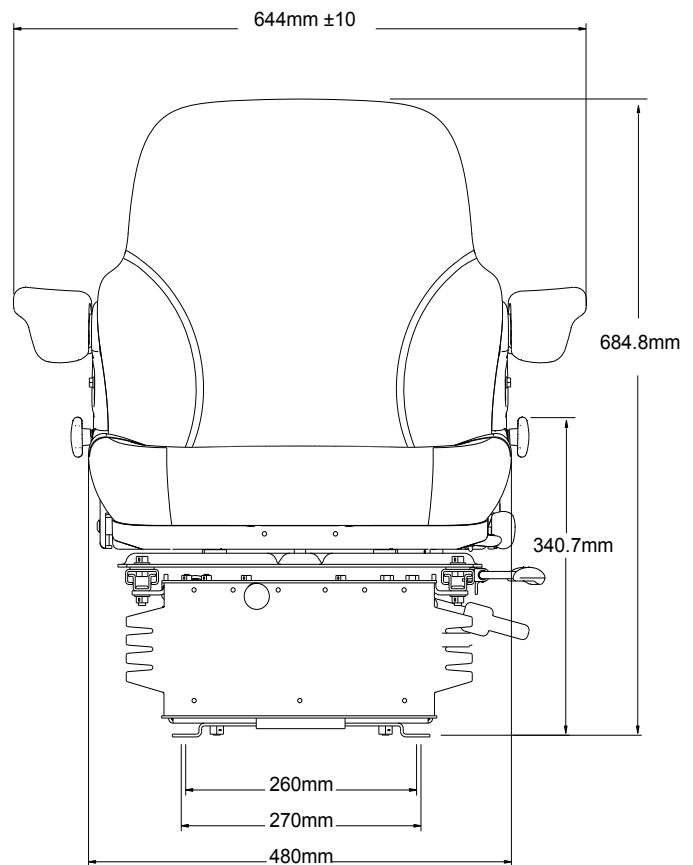



D5565A , Sears seat part No. SA30582.400

- 1 Adjustable backrest height provides customised comfort preventing damage from bad posture
- 2 Ergonomically sculptured back support for full range of movement
- 3 Fully adjustable armrests designed for easy angle adjustment on the move. These fully fold up & feature substantial foam padding for improved comfort when turning in the seat
- 4 Seat cushion extension 60mm (2 1/4") in 5 steps providing thigh support whatever your height
- 5 Swivel 24° rotational adjustment left and right with lock in, lock out, free swivel facility. Making it easier when driving, getting in and out of the seat or using a rear attachment
- 6 Seat cushion angle adjustment reduces pressure on the back of the knees
- 7 Low natural frequency Airide® suspension
- 8 Slide travel range - 200mm
Roller slides for smooth seat positioning
- 9 Infinite seat back angle adjustment
- 10 Armrest mounted air valve switch for simple and accurate finger tip control
- 11 Electric air lumbar support
- the air lumbar support moulds itself to your back, quickly and exactly

53883 Compressor Service Kit 12V	53884 Air Spring Service Kit
--	--

SPECIFICATIONS

- Back recline adjustment
- Fabric cushions (pour in place)
- Integrated backrest extension
- Lumbar - electric
- Seat cushion length adj
- Seat cushion angle adj
- Low Frequency Pneumatic (12v)
- ARPS (auto ride position system)
- Fixed shock absorber
- Integrated fore/ aft isolator
- Armrests - tilt up, angle + height adj
- Swivel 24 deg
- Dlx fore/ aft slides 200mm travel
- Operator presence switch
- Document holder
- Supplied with multifix mounting kit
- Seat cushion width 560mm
- Width across armrests 645mm
- Seat Index Point SIP ---
- Weight Adjustment
- Height Adjustment

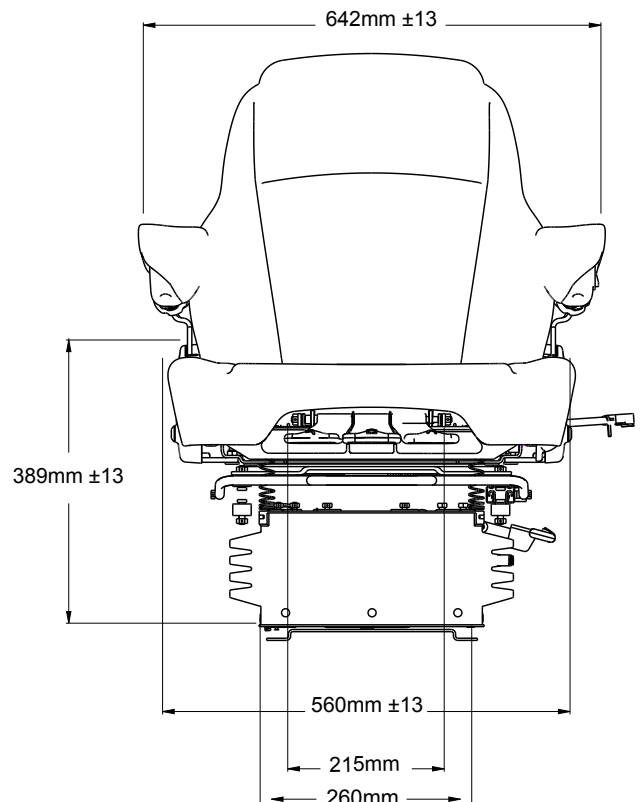

MASSEY FERGUSON

61808



Seat Kit Complete 35 35X 135
6993 x 1 61629 x 1 891870 x 1

891870



Seat Pan 35 35X 65 135 165
Bucket Type Red Also fits 185
188 240 265 290 Also fits TE20
TEA20 TED20 TEF20 TO20 T20

61629



Seat Lower Bracket
Assembly 35 35X 135

6993

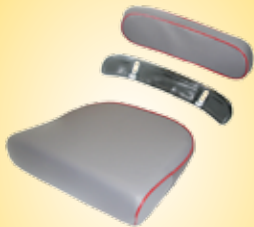

Seat Cushion & Back Rest Kit
35 135

6742



Seat Back 35 165 175

181323



Back Rest Plate with Bolt

61530



Cover to Suit 6742
Backrest

61975



Seat Hinge for 35 135
Seat

61630



Seat to Spring
Bumper 35
35X 135

61632



Seat to Hinge Pin 35 35X 7 1/2" Long

61633



Seat to Hinge Pin 35 35X (6 7/8" Long)

1894548

Spring Seat

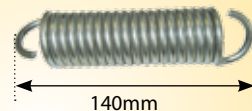

140mm

3495

Spring Seat

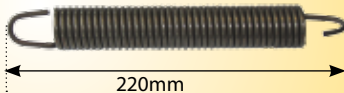

220mm

61484



Seat Passenger
4200 4300

FORK LIFT SEAT

3107 Seat Fork Lift



Slide Base Width Adjustable
Minimum = 200mm
Maximum = 350mm

FIAT



41768

Seat Passenger
Fiat New Holland
90

VINTAGE TRACTORS

MASSEY FERGUSON

61499



Seat Pan 20D TVO
9 Hole

61834



Seat Cushion 20D
- Black

7962



Seat Spring TE 20 TEA 20
TED 20 TEF 20

52844



Base=200mm
Seat Bucket
Deluxe Red

FORDSON

51565



Stud for Bucket Seat
(Add 353426 (H904)
Nut t
*** ADD 353426 to this
item ***

48825

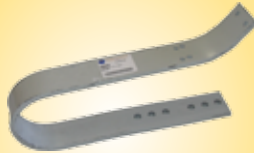

Seat Spring Fordson N's
NAA/2000/8N/800

MAJOR

41329

Seat Cushion & Back Rest
Kit for Major
Has hump in cushion



41329F

Seat Cushion &
Back Rest Kit for
Major
This is Flat



41570



Seat Pan Fordson
Major - 22 Hole

DEXTA

48824



Seat Ford N's - 6 Holes
NAA 2000 8N 800 900 **
48825 is Seat Spring *

41328

Seat Cushion & Back Rest
Kit for Dexta



41328F

Seat Cushion & Back Rest
Kit for Dexta
Flat

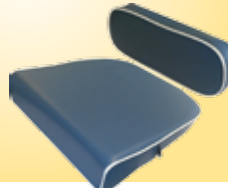

41602



Seat Pan Ford Super
Dexta

41628



Seat Bracket
Fordson Dexta

FORD

41566



Seat Ford 2000 - 7000

41621



Base=110mm

Seat Pan Ford 2000 - 7000
Seat is 41566 4100 5100

41904



Seat Cushion Ford c/w Logo
Red

41903



Seat Cushion Ford c/w Logo
Blue

JOHN DEERE

4901



Seat John Deere Tractor

59769



Seat John Deere Gator



58827 Passenger Seat John Deere 5000s
OE Ref: LVB25717

51806



Seat Belt Automatic 2 Points

59071

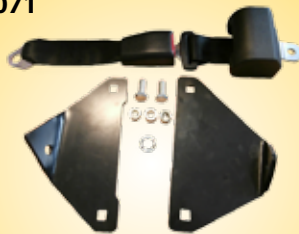

Seat Belt Kit John Deere Passenger Seat** Passenger Seat is 59902 **

59902

Seat Passenger John Deere Bracket 59115



DAVID BROWN

51531



Seat David Brown Cushion & Back Rest Kit

51532

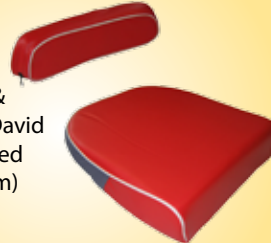

Seat Cushion & Back Rest Kit David Brown R+W (Red with White Trim)

51533



Seat Cushion & Back Rest Kit David Brown (Red with Yellow Trim)

53430



Seat Cover Back For 51531

53428



Seat Cover Back For 51532

53429



Seat Cover Back For 51533

52768R

Seat David Brown Red 885 990 995 996 1210 1212 1410 1412



52768

Seat David Brown 885 990 995 996 1210 1212 1410 1412 Black



NUFFIELD

51535



Seat Cushion (Green) Nuffield

INTERNATIONAL

51534

Seat Cushion & Back Rest Kit (Intl)



51537



Seat Cushion - Red

52657



Seat Cushion IHC
Old Type Red

52658



Seat Cushion IHC
Old Type Black

SEAT COVERS

51658



Seat Cover for Tractor

51659













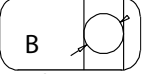

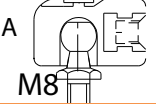
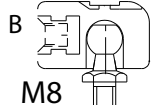

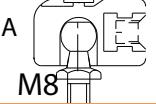
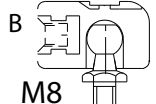

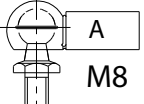

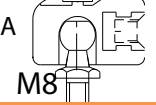
Seat Cover - Van/ 4x4 (Hi back)

Gas Struts

Note:

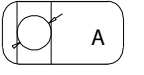









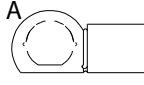
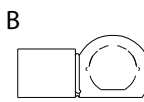

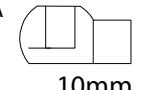
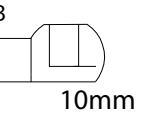
Check Newton Rating Of Existing Gas Strut Before Ordering A Replacement. Using A Gas Strut With A Lower Or Higher Newton Rating Can Result In Damage Or Glass Breakage.

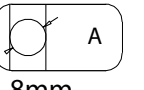
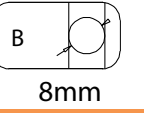
 <p>41766</p>	<table border="1"> <thead> <tr> <th>Application</th> <th>Models</th> </tr> </thead> <tbody> <tr> <td>Bonnet</td> <td>8160, 8260, 8360, 8560 TM115, TM120, TM125, TM130, TM135, TM140, TM150, TM155, TM165</td> </tr> </tbody> </table>	Application	Models	Bonnet	8160, 8260, 8360, 8560 TM115, TM120, TM125, TM130, TM135, TM140, TM150, TM155, TM165	 <p>A 10mm</p>			
	Application	Models							
Bonnet	8160, 8260, 8360, 8560 TM115, TM120, TM125, TM130, TM135, TM140, TM150, TM155, TM165								
<table border="1"> <thead> <tr> <th>Force (N)</th> <th>Length (mm)</th> <th>Ram (mm)</th> <th>OE Ref</th> </tr> </thead> <tbody> <tr> <td>500</td> <td>900</td> <td>400</td> <td>82019392</td> </tr> </tbody> </table>	Force (N)	Length (mm)	Ram (mm)	OE Ref	500	900	400	82019392	 <p>B 10mm</p>
Force (N)	Length (mm)	Ram (mm)	OE Ref						
500	900	400	82019392						
 <p>41285</p>	<table border="1"> <thead> <tr> <th>Application</th> <th>Models</th> </tr> </thead> <tbody> <tr> <td>Rear window</td> <td>3050, 3060, 3065, 3070, 3075, 3080, 3085, 3090, 3095, 3115, 3120, 3125 3610, 3630, 3635, 3645, 3650, 3655, 3670, 3680, 3690</td> </tr> </tbody> </table>	Application	Models	Rear window	3050, 3060, 3065, 3070, 3075, 3080, 3085, 3090, 3095, 3115, 3120, 3125 3610, 3630, 3635, 3645, 3650, 3655, 3670, 3680, 3690	 <p>A M8</p>			
	Application	Models							
Rear window	3050, 3060, 3065, 3070, 3075, 3080, 3085, 3090, 3095, 3115, 3120, 3125 3610, 3630, 3635, 3645, 3650, 3655, 3670, 3680, 3690								
<table border="1"> <thead> <tr> <th>Force (N)</th> <th>Length (mm)</th> <th>Ram (mm)</th> <th>OE Ref</th> </tr> </thead> <tbody> <tr> <td>250</td> <td>785</td> <td>350</td> <td>3389556M2</td> </tr> </tbody> </table>	Force (N)	Length (mm)	Ram (mm)	OE Ref	250	785	350	3389556M2	 <p>B M8</p>
Force (N)	Length (mm)	Ram (mm)	OE Ref						
250	785	350	3389556M2						
 <p>61285</p>	<table border="1"> <thead> <tr> <th>Application</th> <th>Models</th> </tr> </thead> <tbody> <tr> <td>Rear window</td> <td>3050, 3060, 3065, 3070, 3075, 3080, 3085, 3090, 3095, 3115, 3120, 3125 3610, 3630, 3635, 3645, 3650, 3655, 3670, 3680, 3690</td> </tr> </tbody> </table>	Application	Models	Rear window	3050, 3060, 3065, 3070, 3075, 3080, 3085, 3090, 3095, 3115, 3120, 3125 3610, 3630, 3635, 3645, 3650, 3655, 3670, 3680, 3690	 <p>A M8</p>			
	Application	Models							
Rear window	3050, 3060, 3065, 3070, 3075, 3080, 3085, 3090, 3095, 3115, 3120, 3125 3610, 3630, 3635, 3645, 3650, 3655, 3670, 3680, 3690								
<table border="1"> <thead> <tr> <th>Force (N)</th> <th>Length (mm)</th> <th>Ram (mm)</th> <th>OE Ref</th> </tr> </thead> <tbody> <tr> <td>250</td> <td>785</td> <td>350</td> <td>3389556M2</td> </tr> </tbody> </table>	Force (N)	Length (mm)	Ram (mm)	OE Ref	250	785	350	3389556M2	 <p>B M8</p>
Force (N)	Length (mm)	Ram (mm)	OE Ref						
250	785	350	3389556M2						
 <p>59821</p>	<table border="1"> <thead> <tr> <th>Application</th> <th>Models</th> </tr> </thead> <tbody> <tr> <td>Rear window</td> <td>50 Series 40 Series</td> </tr> </tbody> </table>	Application	Models	Rear window	50 Series 40 Series	 <p>A M8</p>			
	Application	Models							
Rear window	50 Series 40 Series								
<table border="1"> <thead> <tr> <th>Force (N)</th> <th>Length (mm)</th> <th>Ram (mm)</th> <th>OE Ref</th> </tr> </thead> <tbody> <tr> <td>150</td> <td>735</td> <td>324</td> <td>AL35675</td> </tr> </tbody> </table>	Force (N)	Length (mm)	Ram (mm)	OE Ref	150	735	324	AL35675	 <p>B M8</p>
Force (N)	Length (mm)	Ram (mm)	OE Ref						
150	735	324	AL35675						
 <p>1514</p>	<table border="1"> <thead> <tr> <th>Application</th> <th>Models</th> </tr> </thead> <tbody> <tr> <td>Rear window</td> <td>40 Series</td> </tr> </tbody> </table>	Application	Models	Rear window	40 Series	 <p>A M8</p>			
	Application	Models							
Rear window	40 Series								
<table border="1"> <thead> <tr> <th>Force (N)</th> <th>Length (mm)</th> <th>Ram (mm)</th> <th>OE Ref</th> </tr> </thead> <tbody> <tr> <td>150</td> <td>730</td> <td>320</td> <td>AL33170</td> </tr> </tbody> </table>	Force (N)	Length (mm)	Ram (mm)	OE Ref	150	730	320	AL33170	 <p>B M8</p>
Force (N)	Length (mm)	Ram (mm)	OE Ref						
150	730	320	AL33170						
 <p>58905</p>	<table border="1"> <thead> <tr> <th>Application</th> <th>Models</th> </tr> </thead> <tbody> <tr> <td>Bonnet</td> <td>6105R 6110R 6115R 6120R 6125R 6130R</td> </tr> </tbody> </table>	Application	Models	Bonnet	6105R 6110R 6115R 6120R 6125R 6130R	 <p>A 10mm</p>			
	Application	Models							
Bonnet	6105R 6110R 6115R 6120R 6125R 6130R								
<table border="1"> <thead> <tr> <th>Force (N)</th> <th>Length (mm)</th> <th>Ram (mm)</th> <th>OE Ref</th> </tr> </thead> <tbody> <tr> <td>825</td> <td>710</td> <td>315</td> <td>AL214868</td> </tr> </tbody> </table>	Force (N)	Length (mm)	Ram (mm)	OE Ref	825	710	315	AL214868	 <p>B 10mm</p>
Force (N)	Length (mm)	Ram (mm)	OE Ref						
825	710	315	AL214868						
 <p>43164</p>	<table border="1"> <thead> <tr> <th>Application</th> <th>Models</th> </tr> </thead> <tbody> <tr> <td>Bonnet</td> <td>TS100, TS110, TS115, TS80, TS90</td> </tr> </tbody> </table>	Application	Models	Bonnet	TS100, TS110, TS115, TS80, TS90	 <p>A 10mm</p>			
	Application	Models							
Bonnet	TS100, TS110, TS115, TS80, TS90								
<table border="1"> <thead> <tr> <th>Force (N)</th> <th>Length (mm)</th> <th>Ram (mm)</th> <th>OE Ref</th> </tr> </thead> <tbody> <tr> <td>450</td> <td>685</td> <td>300</td> <td>82011092</td> </tr> </tbody> </table>	Force (N)	Length (mm)	Ram (mm)	OE Ref	450	685	300	82011092	 <p>B 10mm</p>
Force (N)	Length (mm)	Ram (mm)	OE Ref						
450	685	300	82011092						

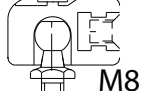
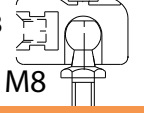
Gas Struts

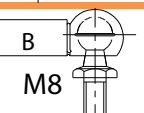
Note:

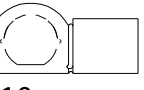
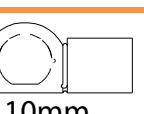

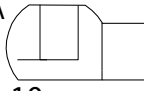
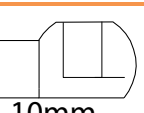





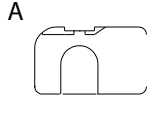
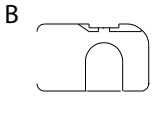

Check Newton Rating Of Existing Gas Strut Before Ordering A Replacement. Using A Gas Strut With A Lower Or Higher Newton Rating Can Result In Damage Or Glass Breakage.

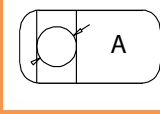
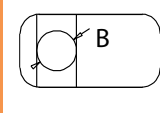
58904 	Application Bonnet	Models 6130R 6140R 6145R 6150R 6155R 6175R 6195R 6215R 6130M 6135M 6140M 6145M 6150M 6155M 6170M 6175M	 
	Force (N) 750	Length (mm) 620	Ram (mm) 250
780167 	Application Rear window	Models Renault 12-14 61-12 61-14 68-12 68-14 75-14 77-12 77-14 85-12 85-14 95-12 95-14 103-12 103-14 110-14	 
	Force (N) 150	Length (mm) 605	Ram (mm) 260
780163 	Application Rear window	Models Renault 781 781-4 781-4S 781S 851-4 851-4S 891 891-S 891-4S 951 951-4 981 981-4 981-4S 981S	 
	Force (N) 400	Length (mm) 600	Ram (mm) 265
61951 	Application Rear window	Models 5425-5480 6110-6190 6235-6290 6445-6499 7465-7495 8110-8180 8210-8280	 
	Force (N) 150	Length (mm) 585	Ram (mm) 255
407119 	Application Rear window	Models 4635, 4835, 5635, 6635, 7635 5640, 6640, 7740, 7840, 8240, 8340 8160, 8260, 8360, 8560 L60, L65, L75, L85, L95 M100, M115, M135, M160 TL100, TL100A, TL70, TL70 A, TL80, TL80A, TL90, TL90A TM110-TM190, TS120, TS80, TL80 A -TL100 A	 
	Force (N) 220	Length (mm) 585	Ram (mm) 255
780168 	Application Rear Window	Models Ares 540, 546, 550, 556, 566, 610, 616, 620, 626, 630, 636, 696, 710, Ares 715, 720, 725, 735, 816, 826, Atles 915, 925, 926, 935, 936	 
	Force (N) 175	Length (mm) 565	Ram (mm) 240
53184 	Application Rear window	Models 3230 4210, 4220, 4230, 4240 844 955, 1055, 1255, 1455 856, 956, 1056 485, 685, 785, 885	 
	Force (N) 180	Length (mm) 550	Ram (mm) 235

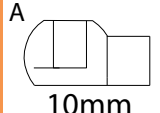
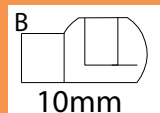
Gas Struts

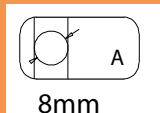
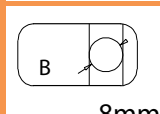
Note:

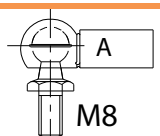
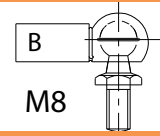
Check Newton Rating Of Existing Gas Strut Before Ordering A Replacement. Using A Gas Strut With A Lower Or Higher Newton Rating Can Result In Damage Or Glass Breakage.

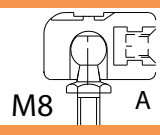
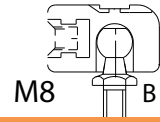
59069 	Application	Models			 A
	Bonnet	6020 Series 6030 Series 6025 Series			
	Force (N)	Length (mm)	Ram (mm)	OE Ref	 B
	510	550	205	AL174088	
59078 	Application	Models			 A
	Bonnet	6020 Series 6030 Series 7030 Series			
	Force (N)	Length (mm)	Ram (mm)	OE Ref	 B
	800	545	190	AL174087	
59079 	Application	Models			 A 10mm
	Sun roof	6000 Series 6010 Series 6020 Series 6030 Series 7030 Series			
	Force (N)	Length (mm)	Ram (mm)	OE Ref	 B 10mm
	200	515	220	AL160699	
3935E 	Application	Models			 A 8mm
	Rear window	550, 560, 565, 575, 590, 595			
	Force (N)	Length (mm)	Ram (mm)	OE Ref	 B 8mm
	350	505	210		
2836 	Application	Models			 A M8
	Door	2910, 3610, 3910, 4110, 4610, 5610, 6610, 7610 3430, 3930, 4630, 4830, 5030			
	Force (N)	Length (mm)	Ram (mm)	OE Ref	 B M8
	220	505	205	83944272	
2834 	Application	Models			 A M8
	Rear window	2610, 2910, 3610, 3910, 4110, 4610, 5110, 5610, 6410, 6610, 7410, 7610, 7710 3230, 3430, 3930, 4630, 4830, 5030			
	Force (N)	Length (mm)	Ram (mm)	OE Ref	 B M8
	200	500	210	83932024	

Gas Struts



Note:

Check Newton Rating Of Existing Gas Strut Before Ordering A Replacement. Using A Gas Strut With A Lower Or Higher Newton Rating Can Result In Damage Or Glass Breakage.

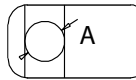
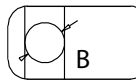

 <p>3935</p>	<table border="1"> <thead> <tr> <th>Application</th> <th>Models</th> </tr> </thead> <tbody> <tr> <td>Rear window</td> <td>550, 560, 565, 575, 590, 595</td> </tr> </tbody> </table>	Application	Models	Rear window	550, 560, 565, 575, 590, 595	 <p>A M8</p>			
	Application	Models							
Rear window	550, 560, 565, 575, 590, 595								
<table border="1"> <thead> <tr> <th>Force (N)</th> <th>Length (mm)</th> <th>Ram (mm)</th> <th>OE Ref</th> </tr> </thead> <tbody> <tr> <td>350</td> <td>500</td> <td>210</td> <td></td> </tr> </tbody> </table>	Force (N)	Length (mm)	Ram (mm)	OE Ref	350	500	210		 <p>B M8</p>
Force (N)	Length (mm)	Ram (mm)	OE Ref						
350	500	210							
 <p>59371</p>	<table border="1"> <thead> <tr> <th>Application</th> <th>Models</th> </tr> </thead> <tbody> <tr> <td>Rear window</td> <td>6000 Series 6010 Series 6020 Series 6030 Series</td> </tr> </tbody> </table>	Application	Models	Rear window	6000 Series 6010 Series 6020 Series 6030 Series	 <p>A M8</p>			
	Application	Models							
Rear window	6000 Series 6010 Series 6020 Series 6030 Series								
<table border="1"> <thead> <tr> <th>Force (N)</th> <th>Length (mm)</th> <th>Ram (mm)</th> <th>OE Ref</th> </tr> </thead> <tbody> <tr> <td>130</td> <td>500</td> <td>195</td> <td>AL114803</td> </tr> </tbody> </table>	Force (N)	Length (mm)	Ram (mm)	OE Ref	130	500	195	AL114803	 <p>B M8</p>
Force (N)	Length (mm)	Ram (mm)	OE Ref						
130	500	195	AL114803						
 <p>6162</p>	<table border="1"> <thead> <tr> <th>Application</th> <th>Models</th> </tr> </thead> <tbody> <tr> <td>Rear window</td> <td>342, 350, 352, 355, 360, 362, 365, 372, 375, 382, 390, 396, 398, 399</td> </tr> </tbody> </table>	Application	Models	Rear window	342, 350, 352, 355, 360, 362, 365, 372, 375, 382, 390, 396, 398, 399	 <p>A M8</p>			
	Application	Models							
Rear window	342, 350, 352, 355, 360, 362, 365, 372, 375, 382, 390, 396, 398, 399								
<table border="1"> <thead> <tr> <th>Force (N)</th> <th>Length (mm)</th> <th>Ram (mm)</th> <th>OE Ref</th> </tr> </thead> <tbody> <tr> <td>200</td> <td>500</td> <td>205</td> <td>3476187M1</td> </tr> </tbody> </table>	Force (N)	Length (mm)	Ram (mm)	OE Ref	200	500	205	3476187M1	 <p>B M8</p>
Force (N)	Length (mm)	Ram (mm)	OE Ref						
200	500	205	3476187M1						
 <p>3559</p>	<table border="1"> <thead> <tr> <th>Application</th> <th>Models</th> </tr> </thead> <tbody> <tr> <td>Rear window</td> <td>240, 250, 265, 275, 290 2620, 2640, 2645, 2680, 2685, 2720, 2725 550, 565, 575, 590, 595</td> </tr> </tbody> </table>	Application	Models	Rear window	240, 250, 265, 275, 290 2620, 2640, 2645, 2680, 2685, 2720, 2725 550, 565, 575, 590, 595	 <p>A M8</p>			
	Application	Models							
Rear window	240, 250, 265, 275, 290 2620, 2640, 2645, 2680, 2685, 2720, 2725 550, 565, 575, 590, 595								
<table border="1"> <thead> <tr> <th>Force (N)</th> <th>Length (mm)</th> <th>Ram (mm)</th> <th>OE Ref</th> </tr> </thead> <tbody> <tr> <td>250</td> <td>500</td> <td>210</td> <td>1873903M1</td> </tr> </tbody> </table>	Force (N)	Length (mm)	Ram (mm)	OE Ref	250	500	210	1873903M1	 <p>B M8</p>
Force (N)	Length (mm)	Ram (mm)	OE Ref						
250	500	210	1873903M1						
 <p>4705</p>	<table border="1"> <thead> <tr> <th>Application</th> <th>Models</th> </tr> </thead> <tbody> <tr> <td>Rear window</td> <td>90 Series - 100-90</td> </tr> </tbody> </table>	Application	Models	Rear window	90 Series - 100-90	 <p>A 8mm</p>			
	Application	Models							
Rear window	90 Series - 100-90								
<table border="1"> <thead> <tr> <th>Force (N)</th> <th>Length (mm)</th> <th>Ram (mm)</th> <th>OE Ref</th> </tr> </thead> <tbody> <tr> <td>250</td> <td>500</td> <td>200</td> <td></td> </tr> </tbody> </table>	Force (N)	Length (mm)	Ram (mm)	OE Ref	250	500	200		 <p>B 8mm</p>
Force (N)	Length (mm)	Ram (mm)	OE Ref						
250	500	200							
 <p>2320</p>	<table border="1"> <thead> <tr> <th>Application</th> <th>Models</th> </tr> </thead> <tbody> <tr> <td>Rear window</td> <td>100-90, 110-90, 115-90, 55-90, 60-90, 65-90, 70-90, 80-90, 85-90, 90-90 60-94, 65-94, 72-94, 82-94, 88-94</td> </tr> </tbody> </table>	Application	Models	Rear window	100-90, 110-90, 115-90, 55-90, 60-90, 65-90, 70-90, 80-90, 85-90, 90-90 60-94, 65-94, 72-94, 82-94, 88-94	 <p>A 8mm</p>			
	Application	Models							
Rear window	100-90, 110-90, 115-90, 55-90, 60-90, 65-90, 70-90, 80-90, 85-90, 90-90 60-94, 65-94, 72-94, 82-94, 88-94								
<table border="1"> <thead> <tr> <th>Force (N)</th> <th>Length (mm)</th> <th>Ram (mm)</th> <th>OE Ref</th> </tr> </thead> <tbody> <tr> <td>130</td> <td>500</td> <td>200</td> <td>5113767</td> </tr> </tbody> </table>	Force (N)	Length (mm)	Ram (mm)	OE Ref	130	500	200	5113767	 <p>B 8mm</p>
Force (N)	Length (mm)	Ram (mm)	OE Ref						
130	500	200	5113767						

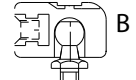

Gas Struts **Note:** Check newton rating of existing gas strut before ordering a replacement. Using a gas strut with a lower or higher newton rating can result in damage or glass breakage.

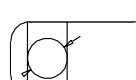
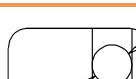
	780162	Application	Models		
		Rear Window	891, 891-4, 891-4S, 891S, 751-4S, 751S 951, 951-4, 981-4S, 981S, 981, 981-4 681, 681-4, 681-4S, 681S		
		Force (N)	Length (mm)	Ram (mm)	OE Ref
		150	500	215	7701025587

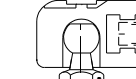
	59818	Application	Models		
		Rear window	40 Series		
		Force (N)	Length (mm)	Ram (mm)	OE Ref
		200	495	205	AL33170

	780161	Application	Models		
		Rear window	Renault 100 461 5515 651 651-4 681 681-4 681-4S 681S 751S 781-4S 752 785		
		Force (N)	Length (mm)	Ram (mm)	OE Ref
		400	495	206	7701350668

	6716	Application	Models		
		Door	4215, 4220, 4225, 4235, 4240, 4245, 4255, 4260, 4265, 4270, 4315, 4320, 4325, 4335, 4345, 4355, 4360, 4365, 4370		
		Force (N)	Length (mm)	Ram (mm)	OE Ref
		150	490	200	3804759M1

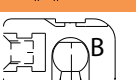
	52092	Application	Models		
		Rear window	CX100, CX50, CX60, CX70, CX80, CX90 MX100, MX100 C, MX110, MX120, MX135, MX150, MX170, MX180, MX200, MX220, MX240, MX80 C, MX90 C		
		Force (N)	Length (mm)	Ram (mm)	OE Ref
		200	485	205	189447A2

3943



8-18 Steel Eye for Gas Struts - All Gas Strut

3942



Ball Joint 8-18 Steel - All Gas Strut

6491



Roof Hatch Gas Strut Clip
390 390T 398 398T

41075



Gas Strut Bracket Ford Case John Deere Case 484 584 684 784 884
John Deere 1030 1040 1130
1140 1630 940

Gas Struts

Note: Check newton rating of existing gas strut before ordering a replacement. Using a gas strut with a lower or higher newton rating can result in damage or glass breakage.

6353 	Application Models Rear window	A  8mm B  8mm
	Force (N) Length (mm) Ram (mm) OE Ref 200 485 205 3548042M91	
780165 	Application Models Door Renault 12-14 55-12 55-14 70-12 70-14 80-14	A  10mm B  10mm
	Force (N) Length (mm) Ram (mm) OE Ref 200 485 205 6005012549	
43533 	Application Models Rear window T6040 T6050 T6060 T6070 T6080 T7030 T7040 T7050 T7060 TS100A TS110A TS115A TS125A	A  10mm B  10mm
	Force (N) Length (mm) Ram (mm) OE Ref 485 485 245 82022486	
3621 	Application Models Rear window	A  M8 B  M8
	Force (N) Length (mm) Ram (mm) OE Ref 350 415 170	
59675 	Application Models Door UR3 Series 7520, 7540, 8520, 8540, 9520, 9540, 10520, 10540	A  M8 B  M8
	Force (N) Length (mm) Ram (mm) OE Ref 200 410 165 10368919	
3659 	Application Models Rear window UR1 Series - 5211, 5245, 6211, 6245, 7211, 7245, 7711, 7745	A  8mm B  8mm
	Force (N) Length (mm) Ram (mm) OE Ref 180 410 155 822155218Z2018L	

Gas Struts **Note:** Check newton rating of existing gas strut before ordering a replacement. Using a gas strut with a lower or higher newton rating can result in damage or glass breakage.

 <p>780172</p>	<table border="1"> <thead> <tr> <th>Application</th> <th>Models</th> </tr> </thead> <tbody> <tr> <td>Door</td> <td>55-12 F, 55-12 LB, 55-12 V, 55-14 V, 70-12 F, 70-12 LB, 70-12 V, 70-14 F, 70-14 LB, 80-12 F, 80-12 V, 80-14 F, 80-14 LB, 80-14 V, Dionis 110, 120, 130, 140, Fructus 110, 120, 130, 140, Pales 210, 220, 230, 240</td> </tr> <tr> <th>Force (N)</th> <th>Length (mm)</th> <th>Ram (mm)</th> <th>OE Ref</th> </tr> <tr> <td>200</td> <td>410</td> <td>160</td> <td>6005012542</td> </tr> </tbody> </table>	Application	Models	Door	55-12 F, 55-12 LB, 55-12 V, 55-14 V, 70-12 F, 70-12 LB, 70-12 V, 70-14 F, 70-14 LB, 80-12 F, 80-12 V, 80-14 F, 80-14 LB, 80-14 V, Dionis 110, 120, 130, 140, Fructus 110, 120, 130, 140, Pales 210, 220, 230, 240	Force (N)	Length (mm)	Ram (mm)	OE Ref	200	410	160	6005012542	 <p>10mm</p>  <p>10mm</p>
Application	Models													
Door	55-12 F, 55-12 LB, 55-12 V, 55-14 V, 70-12 F, 70-12 LB, 70-12 V, 70-14 F, 70-14 LB, 80-12 F, 80-12 V, 80-14 F, 80-14 LB, 80-14 V, Dionis 110, 120, 130, 140, Fructus 110, 120, 130, 140, Pales 210, 220, 230, 240													
Force (N)	Length (mm)	Ram (mm)	OE Ref											
200	410	160	6005012542											
 <p>59681</p>	<table border="1"> <thead> <tr> <th>Application</th> <th>Models</th> </tr> </thead> <tbody> <tr> <td>Back Window</td> <td>UR1 Series 5211, 5245, 6211, 6245, 7211, 7245, 7711, 7745</td> </tr> <tr> <th>Force (N)</th> <th>Length (mm)</th> <th>Ram (mm)</th> <th>OE Ref</th> </tr> <tr> <td>200</td> <td>400</td> <td>151</td> <td>60117921</td> </tr> </tbody> </table>	Application	Models	Back Window	UR1 Series 5211, 5245, 6211, 6245, 7211, 7245, 7711, 7745	Force (N)	Length (mm)	Ram (mm)	OE Ref	200	400	151	60117921	 <p>10mm</p>  <p>10mm</p>
Application	Models													
Back Window	UR1 Series 5211, 5245, 6211, 6245, 7211, 7245, 7711, 7745													
Force (N)	Length (mm)	Ram (mm)	OE Ref											
200	400	151	60117921											
 <p>1481</p>	<table border="1"> <thead> <tr> <th>Application</th> <th>Models</th> </tr> </thead> <tbody> <tr> <td>Rear window</td> <td>C & G Cabs</td> </tr> <tr> <th>Force (N)</th> <th>Length (mm)</th> <th>Ram (mm)</th> <th>OE Ref</th> </tr> <tr> <td>140</td> <td>395</td> <td>150</td> <td></td> </tr> </tbody> </table>	Application	Models	Rear window	C & G Cabs	Force (N)	Length (mm)	Ram (mm)	OE Ref	140	395	150		 <p>M8</p>  <p>M8</p>
Application	Models													
Rear window	C & G Cabs													
Force (N)	Length (mm)	Ram (mm)	OE Ref											
140	395	150												
 <p>780166</p>	<table border="1"> <thead> <tr> <th>Application</th> <th>Models</th> </tr> </thead> <tbody> <tr> <td>Rear window</td> <td>Renault 12-14 61-12 61-14 75-14 Renault 12-14 61-12 61-14 75-14 95-14 103-12 103-14 70-12 70-14 80-12 80-14 110-14</td> </tr> <tr> <th>Force (N)</th> <th>Length (mm)</th> <th>Ram (mm)</th> <th>OE Ref</th> </tr> <tr> <td>180</td> <td>390</td> <td>155</td> <td>7700005276</td> </tr> </tbody> </table>	Application	Models	Rear window	Renault 12-14 61-12 61-14 75-14 Renault 12-14 61-12 61-14 75-14 95-14 103-12 103-14 70-12 70-14 80-12 80-14 110-14	Force (N)	Length (mm)	Ram (mm)	OE Ref	180	390	155	7700005276	 <p>8mm</p>  <p>8mm</p>
Application	Models													
Rear window	Renault 12-14 61-12 61-14 75-14 Renault 12-14 61-12 61-14 75-14 95-14 103-12 103-14 70-12 70-14 80-12 80-14 110-14													
Force (N)	Length (mm)	Ram (mm)	OE Ref											
180	390	155	7700005276											
 <p>2107</p>	<table border="1"> <thead> <tr> <th>Application</th> <th>Models</th> </tr> </thead> <tbody> <tr> <td>Rear window</td> <td>2610, 3610, 4110, 4610, 5610, 6410, 6610, 6710, 6810, 7410, 7610, 7710, 7810, 7910, 8210 8530, 8630, 8730, 8830 TW5-TW35 5900</td> </tr> <tr> <th>Force (N)</th> <th>Length (mm)</th> <th>Ram (mm)</th> <th>OE Ref</th> </tr> <tr> <td>160</td> <td>375</td> <td>150</td> <td>83952213</td> </tr> </tbody> </table>	Application	Models	Rear window	2610, 3610, 4110, 4610, 5610, 6410, 6610, 6710, 6810, 7410, 7610, 7710, 7810, 7910, 8210 8530, 8630, 8730, 8830 TW5-TW35 5900	Force (N)	Length (mm)	Ram (mm)	OE Ref	160	375	150	83952213	 <p>M8</p>  <p>M8</p>
Application	Models													
Rear window	2610, 3610, 4110, 4610, 5610, 6410, 6610, 6710, 6810, 7410, 7610, 7710, 7810, 7910, 8210 8530, 8630, 8730, 8830 TW5-TW35 5900													
Force (N)	Length (mm)	Ram (mm)	OE Ref											
160	375	150	83952213											
 <p>780170</p>	<table border="1"> <thead> <tr> <th>Application</th> <th>Models</th> </tr> </thead> <tbody> <tr> <td>Rear Window</td> <td>Cergos Series Cergos 330, Cergos 335, Cergos 340, Cergos 345, Cergos 350, Cergos 355</td> </tr> <tr> <th>Force (N)</th> <th>Length (mm)</th> <th>Ram (mm)</th> <th>OE Ref</th> </tr> <tr> <td>300</td> <td>370</td> <td>145</td> <td>6005022224</td> </tr> </tbody> </table>	Application	Models	Rear Window	Cergos Series Cergos 330, Cergos 335, Cergos 340, Cergos 345, Cergos 350, Cergos 355	Force (N)	Length (mm)	Ram (mm)	OE Ref	300	370	145	6005022224	 <p>10mm</p>  <p>10mm</p>
Application	Models													
Rear Window	Cergos Series Cergos 330, Cergos 335, Cergos 340, Cergos 345, Cergos 350, Cergos 355													
Force (N)	Length (mm)	Ram (mm)	OE Ref											
300	370	145	6005022224											
 <p>59770</p>	<table border="1"> <thead> <tr> <th>Application</th> <th>Models</th> </tr> </thead> <tbody> <tr> <td>Bonnet</td> <td>6000 Series 6010 SE Series 6010 Series</td> </tr> <tr> <th>Force (N)</th> <th>Length (mm)</th> <th>Ram (mm)</th> <th>OE Ref</th> </tr> <tr> <td>900</td> <td>355</td> <td>105</td> <td>AL77767</td> </tr> </tbody> </table>	Application	Models	Bonnet	6000 Series 6010 SE Series 6010 Series	Force (N)	Length (mm)	Ram (mm)	OE Ref	900	355	105	AL77767	 <p>10mm</p>  <p>8.1mm</p>
Application	Models													
Bonnet	6000 Series 6010 SE Series 6010 Series													
Force (N)	Length (mm)	Ram (mm)	OE Ref											
900	355	105	AL77767											

Gas Struts **Note:** Check newton rating of existing gas strut before ordering a replacement. Using a gas strut with a lower or higher newton rating can result in damage or glass breakage.

3658 	Application	Models			 8mm
	Rear window	UR1 Series, UR2 Series			 8mm
	Force (N)	Length (mm)	Ram (mm)	OE Ref	
	175	325	110	981468 175N EE	
780164 	Application	Models			 10mm
	Sun roof	Renault 12-14 55-12 55-14 70-12 70-14 80-14			 10mm
	Force (N)	Length (mm)	Ram (mm)	OE Ref	
	200	325	125	6005014318	
1332 	Application	Models			 M8
	Rear window	135			 M8
	Force (N)	Length (mm)	Ram (mm)	OE Ref	
	250	290	90		
3672 	Application	Models			 8mm
	Rear window	Duncan Cab - New Type			 8mm
	Force (N)	Length (mm)	Ram (mm)	OE Ref	
	350	285	95		
3933 	Application	Models			 8mm
	Rear window	Leyland			 8mm
	Force (N)	Length (mm)	Ram (mm)	OE Ref	
	300	280	90		
6389 	Application	Models			 M8
	Door	240, 250, 265, 275, 290 350, 355, 360, 362, 365, 375, 390, 390 T, 398, 399			 M8
	Force (N)	Length (mm)	Ram (mm)	OE Ref	
	290	275	85	3478319M1	
59663 	Application	Models			 M8
	Door	6000 Series 6010 Series			 M8
	Force (N)	Length (mm)	Ram (mm)	OE Ref	
	250	260	90	AL110629	

Gas Struts **Note:** Check newton rating of existing gas strut before ordering a replacement. Using a gas strut with a lower or higher newton rating can result in damage or glass breakage.



 <p>2835</p>	<table border="1"> <thead> <tr> <th>Application</th> <th>Models</th> </tr> </thead> <tbody> <tr> <td>Front window</td> <td>2910, 3610, 3910, 4110, 4610, 5610, 6610, 7610</td> </tr> <tr> <th>Force (N)</th> <th>Length (mm)</th> <th>Ram (mm)</th> <th>OE Ref</th> </tr> <tr> <td>100</td> <td>255</td> <td>90</td> <td>83944280</td> </tr> </tbody> </table>	Application	Models	Front window	2910, 3610, 3910, 4110, 4610, 5610, 6610, 7610	Force (N)	Length (mm)	Ram (mm)	OE Ref	100	255	90	83944280	 <p>6.2mm</p>  <p>M8</p>
Application	Models													
Front window	2910, 3610, 3910, 4110, 4610, 5610, 6610, 7610													
Force (N)	Length (mm)	Ram (mm)	OE Ref											
100	255	90	83944280											
 <p>780171</p>	<table border="1"> <thead> <tr> <th>Application</th> <th>Models</th> </tr> </thead> <tbody> <tr> <td>Door</td> <td>Cergos 330, Cergos 335, Cergos 340, Cergos 345, Cergos 350, Cergos 355 Ergos 105, Ergos 446 Hydro, Ergos 456 Hydro, Ergos 466 Hydro, Ergos 85, Ergos 95</td> </tr> <tr> <th>Force (N)</th> <th>Length (mm)</th> <th>Ram (mm)</th> <th>OE Ref</th> </tr> <tr> <td>200</td> <td>255</td> <td>95</td> <td>6005014361</td> </tr> </tbody> </table>	Application	Models	Door	Cergos 330, Cergos 335, Cergos 340, Cergos 345, Cergos 350, Cergos 355 Ergos 105, Ergos 446 Hydro, Ergos 456 Hydro, Ergos 466 Hydro, Ergos 85, Ergos 95	Force (N)	Length (mm)	Ram (mm)	OE Ref	200	255	95	6005014361	 <p>10mm</p>  <p>10mm</p>
Application	Models													
Door	Cergos 330, Cergos 335, Cergos 340, Cergos 345, Cergos 350, Cergos 355 Ergos 105, Ergos 446 Hydro, Ergos 456 Hydro, Ergos 466 Hydro, Ergos 85, Ergos 95													
Force (N)	Length (mm)	Ram (mm)	OE Ref											
200	255	95	6005014361											
 <p>52091</p>	<table border="1"> <thead> <tr> <th>Application</th> <th>Models</th> </tr> </thead> <tbody> <tr> <td>Door</td> <td>CX100, CX50, CX60, CX70, CX80, CX90 5120, 5130, 5140, 5150 MX100, MX100 C, MX110, MX120, MX135, MX150, MX170, MX80 C, MX90 C</td> </tr> <tr> <th>Force (N)</th> <th>Length (mm)</th> <th>Ram (mm)</th> <th>OE Ref</th> </tr> <tr> <td>350</td> <td>250</td> <td>77</td> <td>1977416C1</td> </tr> </tbody> </table>	Application	Models	Door	CX100, CX50, CX60, CX70, CX80, CX90 5120, 5130, 5140, 5150 MX100, MX100 C, MX110, MX120, MX135, MX150, MX170, MX80 C, MX90 C	Force (N)	Length (mm)	Ram (mm)	OE Ref	350	250	77	1977416C1	 <p>M8</p>  <p>M8</p>
Application	Models													
Door	CX100, CX50, CX60, CX70, CX80, CX90 5120, 5130, 5140, 5150 MX100, MX100 C, MX110, MX120, MX135, MX150, MX170, MX80 C, MX90 C													
Force (N)	Length (mm)	Ram (mm)	OE Ref											
350	250	77	1977416C1											
 <p>59664</p>	<table border="1"> <thead> <tr> <th>Application</th> <th>Models</th> </tr> </thead> <tbody> <tr> <td>Door</td> <td>5020 Series 6030 Series 7030 Series 6030 Premium Series 5025 Series 7030 Premium Series</td> </tr> <tr> <th>Force (N)</th> <th>Length (mm)</th> <th>Ram (mm)</th> <th>OE Ref</th> </tr> <tr> <td>350</td> <td>245</td> <td>70</td> <td>AL174358</td> </tr> </tbody> </table>	Application	Models	Door	5020 Series 6030 Series 7030 Series 6030 Premium Series 5025 Series 7030 Premium Series	Force (N)	Length (mm)	Ram (mm)	OE Ref	350	245	70	AL174358	 <p>M8</p>  <p>M8</p>
Application	Models													
Door	5020 Series 6030 Series 7030 Series 6030 Premium Series 5025 Series 7030 Premium Series													
Force (N)	Length (mm)	Ram (mm)	OE Ref											
350	245	70	AL174358											
 <p>42772</p>	<table border="1"> <thead> <tr> <th>Application</th> <th>Models</th> </tr> </thead> <tbody> <tr> <td>Steering column</td> <td>T6010, T6020, T6030, T6040, T6050, T6060, T6070, T6080, T6090 T7030, T7040, T7050, T7060, T7070 TS100 A, TS110 A, TS115 A, TS125 A, TS130 A, TS135 A</td> </tr> <tr> <th>Force (N)</th> <th>Length (mm)</th> <th>Ram (mm)</th> <th>OE Ref</th> </tr> <tr> <td>350</td> <td>235</td> <td>70</td> <td>82036016</td> </tr> </tbody> </table>	Application	Models	Steering column	T6010, T6020, T6030, T6040, T6050, T6060, T6070, T6080, T6090 T7030, T7040, T7050, T7060, T7070 TS100 A, TS110 A, TS115 A, TS125 A, TS130 A, TS135 A	Force (N)	Length (mm)	Ram (mm)	OE Ref	350	235	70	82036016	 <p>10mm</p>  <p>M10</p>
Application	Models													
Steering column	T6010, T6020, T6030, T6040, T6050, T6060, T6070, T6080, T6090 T7030, T7040, T7050, T7060, T7070 TS100 A, TS110 A, TS115 A, TS125 A, TS130 A, TS135 A													
Force (N)	Length (mm)	Ram (mm)	OE Ref											
350	235	70	82036016											
 <p>59952</p>	<table border="1"> <thead> <tr> <th>Application</th> <th>Models</th> </tr> </thead> <tbody> <tr> <td>Steering column</td> <td>5020 Series 6000 Series 6010 Series 6020 SE Series 6020 Series 6030 Series 5R Series</td> </tr> <tr> <th>Force (N)</th> <th>Length (mm)</th> <th>Ram (mm)</th> <th>OE Ref</th> </tr> <tr> <td>330</td> <td>230</td> <td>65</td> <td>AL150755</td> </tr> </tbody> </table>	Application	Models	Steering column	5020 Series 6000 Series 6010 Series 6020 SE Series 6020 Series 6030 Series 5R Series	Force (N)	Length (mm)	Ram (mm)	OE Ref	330	230	65	AL150755	 <p>10mm</p>  <p>M10</p>
Application	Models													
Steering column	5020 Series 6000 Series 6010 Series 6020 SE Series 6020 Series 6030 Series 5R Series													
Force (N)	Length (mm)	Ram (mm)	OE Ref											
330	230	65	AL150755											
 <p>61950</p>	<table border="1"> <thead> <tr> <th>Application</th> <th>Models</th> </tr> </thead> <tbody> <tr> <td>Door</td> <td>5425, 5435, 5445, 5455, 5460, 5465, 5470, 5480 6110-6190 6235-6290 6445-6499 7465-7495 8110-8180 8210-8280</td> </tr> <tr> <th>Force (N)</th> <th>Length (mm)</th> <th>Ram (mm)</th> <th>OE Ref</th> </tr> <tr> <td>600</td> <td>230</td> <td>70</td> <td>3902121M3</td> </tr> </tbody> </table>	Application	Models	Door	5425, 5435, 5445, 5455, 5460, 5465, 5470, 5480 6110-6190 6235-6290 6445-6499 7465-7495 8110-8180 8210-8280	Force (N)	Length (mm)	Ram (mm)	OE Ref	600	230	70	3902121M3	 <p>M8</p>  <p>M8</p>
Application	Models													
Door	5425, 5435, 5445, 5455, 5460, 5465, 5470, 5480 6110-6190 6235-6290 6445-6499 7465-7495 8110-8180 8210-8280													
Force (N)	Length (mm)	Ram (mm)	OE Ref											
600	230	70	3902121M3											

Gas Struts **Note:** Check newton rating of existing gas strut before ordering a replacement. Using a gas strut with a lower or higher newton rating can result in damage or glass breakage.

<p>2699</p> 	<table border="1"> <thead> <tr> <th>Application</th> <th>Models</th> </tr> </thead> <tbody> <tr> <td>Sun roof</td> <td>2610-8210 8530-8830 5640-8340 8160-8560 M100-M160 TM110-TM180 TS90-TS115 TW5-TW35 5900</td> </tr> <tr> <th>Force (N)</th> <th>Length (mm)</th> <th>Ram (mm)</th> <th>OE Ref</th> </tr> <tr> <td>220</td> <td>220</td> <td>65</td> <td>83949895</td> </tr> </tbody> </table>	Application	Models	Sun roof	2610-8210 8530-8830 5640-8340 8160-8560 M100-M160 TM110-TM180 TS90-TS115 TW5-TW35 5900	Force (N)	Length (mm)	Ram (mm)	OE Ref	220	220	65	83949895	 <p>8mm</p> 
Application	Models													
Sun roof	2610-8210 8530-8830 5640-8340 8160-8560 M100-M160 TM110-TM180 TS90-TS115 TW5-TW35 5900													
Force (N)	Length (mm)	Ram (mm)	OE Ref											
220	220	65	83949895											
<p>52215</p> 	<table border="1"> <thead> <tr> <th>Application</th> <th>Models</th> </tr> </thead> <tbody> <tr> <td>Sun roof</td> <td>1190, 1290, 1390, 1490, 1690 1194, 1294, 1394, 1494, 1594, 1694</td> </tr> <tr> <th>Force (N)</th> <th>Length (mm)</th> <th>Ram (mm)</th> <th>OE Ref</th> </tr> <tr> <td>330</td> <td>220</td> <td>67</td> <td>3901826M91</td> </tr> </tbody> </table>	Application	Models	Sun roof	1190, 1290, 1390, 1490, 1690 1194, 1294, 1394, 1494, 1594, 1694	Force (N)	Length (mm)	Ram (mm)	OE Ref	330	220	67	3901826M91	 <p>8mm</p>  <p>8mm</p>
Application	Models													
Sun roof	1190, 1290, 1390, 1490, 1690 1194, 1294, 1394, 1494, 1594, 1694													
Force (N)	Length (mm)	Ram (mm)	OE Ref											
330	220	67	3901826M91											
<p>41767</p> 	<table border="1"> <thead> <tr> <th>Application</th> <th>Models</th> </tr> </thead> <tbody> <tr> <td>Door</td> <td>5640, 6640, 7740, 7840, 8240, 8340 8160, 8260, 8360, 8560 TM110, TM115, TM120, TM125, TM130, TM135, TM140, TM150, TM155, TM165, TM175, TM180, TM190 TS100, TS110, TS115, TS80, TS90</td> </tr> <tr> <th>Force (N)</th> <th>Length (mm)</th> <th>Ram (mm)</th> <th>OE Ref</th> </tr> <tr> <td>310</td> <td>215</td> <td>57</td> <td>87378324</td> </tr> </tbody> </table>	Application	Models	Door	5640, 6640, 7740, 7840, 8240, 8340 8160, 8260, 8360, 8560 TM110, TM115, TM120, TM125, TM130, TM135, TM140, TM150, TM155, TM165, TM175, TM180, TM190 TS100, TS110, TS115, TS80, TS90	Force (N)	Length (mm)	Ram (mm)	OE Ref	310	215	57	87378324	 <p>M8</p>  <p>M8</p>
Application	Models													
Door	5640, 6640, 7740, 7840, 8240, 8340 8160, 8260, 8360, 8560 TM110, TM115, TM120, TM125, TM130, TM135, TM140, TM150, TM155, TM165, TM175, TM180, TM190 TS100, TS110, TS115, TS80, TS90													
Force (N)	Length (mm)	Ram (mm)	OE Ref											
310	215	57	87378324											
<p>43532</p> 	<table border="1"> <thead> <tr> <th>Application</th> <th>Models</th> </tr> </thead> <tbody> <tr> <td>Door</td> <td>T6050 T6060 T6070 T6080 T7030 T7040 T7050 T7060 TS100A TS110A TS115A TS125A TS130A</td> </tr> <tr> <th>Force (N)</th> <th>Length (mm)</th> <th>Ram (mm)</th> <th>OE Ref</th> </tr> <tr> <td>850</td> <td>215</td> <td>115</td> <td>87374182</td> </tr> </tbody> </table>	Application	Models	Door	T6050 T6060 T6070 T6080 T7030 T7040 T7050 T7060 TS100A TS110A TS115A TS125A TS130A	Force (N)	Length (mm)	Ram (mm)	OE Ref	850	215	115	87374182	 
Application	Models													
Door	T6050 T6060 T6070 T6080 T7030 T7040 T7050 T7060 TS100A TS110A TS115A TS125A TS130A													
Force (N)	Length (mm)	Ram (mm)	OE Ref											
850	215	115	87374182											
<p>4715</p> 	<table border="1"> <thead> <tr> <th>Application</th> <th>Models</th> </tr> </thead> <tbody> <tr> <td>Door/Sun roof</td> <td>2610, 3610, 4110, 4610, 5610, 6410, 6610, 6710, 6810, 7410, 7610, 7710, 7810, 7910, 8210 3230, 3430, 3930, 4630, 8530, 8630, 8730, 8830 TW15, TW25, TW35, TW5 5900</td> </tr> <tr> <th>Force (N)</th> <th>Length (mm)</th> <th>Ram (mm)</th> <th>OE Ref</th> </tr> <tr> <td>300</td> <td>210</td> <td>55</td> <td>83952266</td> </tr> </tbody> </table>	Application	Models	Door/Sun roof	2610, 3610, 4110, 4610, 5610, 6410, 6610, 6710, 6810, 7410, 7610, 7710, 7810, 7910, 8210 3230, 3430, 3930, 4630, 8530, 8630, 8730, 8830 TW15, TW25, TW35, TW5 5900	Force (N)	Length (mm)	Ram (mm)	OE Ref	300	210	55	83952266	 <p>M8</p>  <p>M8</p>
Application	Models													
Door/Sun roof	2610, 3610, 4110, 4610, 5610, 6410, 6610, 6710, 6810, 7410, 7610, 7710, 7810, 7910, 8210 3230, 3430, 3930, 4630, 8530, 8630, 8730, 8830 TW15, TW25, TW35, TW5 5900													
Force (N)	Length (mm)	Ram (mm)	OE Ref											
300	210	55	83952266											
<p>43471</p> 	<table border="1"> <thead> <tr> <th>Application</th> <th>Models</th> </tr> </thead> <tbody> <tr> <td>Door</td> <td>CASE CS CVX</td> </tr> <tr> <th>Force (N)</th> <th>Length (mm)</th> <th>Ram (mm)</th> <th>OE Ref</th> </tr> <tr> <td>500</td> <td>205</td> <td>65</td> <td>134621099</td> </tr> </tbody> </table>	Application	Models	Door	CASE CS CVX	Force (N)	Length (mm)	Ram (mm)	OE Ref	500	205	65	134621099	 <p>10mm</p>  <p>10mm</p>
Application	Models													
Door	CASE CS CVX													
Force (N)	Length (mm)	Ram (mm)	OE Ref											
500	205	65	134621099											
<p>780169</p> 	<table border="1"> <thead> <tr> <th>Application</th> <th>Models</th> </tr> </thead> <tbody> <tr> <td>Door</td> <td>Ares 540 RX, Ares 546 RX, Ares 550 RX, Ares 556 RX, Ares 566 RX, Ares 610 RX, Ares 610 RZ, Ares 616 RX, Ares 620 RZ, Ares 626 RX, Ares 630 RX, Ares 630 RZ, Ares 636 RX, Ares 640 RZ, Ares 696 RX, Ares 710 RZ, Ares 715 RZ, Ares 720 RZ, Ares 725 RZ, Ares 735 RZ, Ares 816 RZ, Ares 826 RZ, Ares 836 RZ</td> </tr> <tr> <th>Force (N)</th> <th>Length (mm)</th> <th>Ram (mm)</th> <th>OE Ref</th> </tr> <tr> <td>200</td> <td>187</td> <td>55</td> <td>7700059809</td> </tr> </tbody> </table>	Application	Models	Door	Ares 540 RX, Ares 546 RX, Ares 550 RX, Ares 556 RX, Ares 566 RX, Ares 610 RX, Ares 610 RZ, Ares 616 RX, Ares 620 RZ, Ares 626 RX, Ares 630 RX, Ares 630 RZ, Ares 636 RX, Ares 640 RZ, Ares 696 RX, Ares 710 RZ, Ares 715 RZ, Ares 720 RZ, Ares 725 RZ, Ares 735 RZ, Ares 816 RZ, Ares 826 RZ, Ares 836 RZ	Force (N)	Length (mm)	Ram (mm)	OE Ref	200	187	55	7700059809	 <p>10mm</p>  <p>10mm</p>
Application	Models													
Door	Ares 540 RX, Ares 546 RX, Ares 550 RX, Ares 556 RX, Ares 566 RX, Ares 610 RX, Ares 610 RZ, Ares 616 RX, Ares 620 RZ, Ares 626 RX, Ares 630 RX, Ares 630 RZ, Ares 636 RX, Ares 640 RZ, Ares 696 RX, Ares 710 RZ, Ares 715 RZ, Ares 720 RZ, Ares 725 RZ, Ares 735 RZ, Ares 816 RZ, Ares 826 RZ, Ares 836 RZ													
Force (N)	Length (mm)	Ram (mm)	OE Ref											
200	187	55	7700059809											

Beacons

<p>51320</p>  <p>Beacon 12V Magnetic c/w Bulb Lucas Type</p>	<p>51332</p>  <p>Beacon 12-80v Mini Xenon</p>	<p>59624</p>  <p>Beacon John Deere 12v Flexi Stem Small</p>	<p>51321</p>  <p>Beacon 12v Flexi Stem Lucas Type</p>	<p>53357</p>  <p>Beacon LED Flexi 12/24V</p>	<p>53358</p>  <p>** USE 53855 WHEN STOCK GONE **</p>
--	---	---	---	--	--

<p>43190K Beacon Work Lamp Bracket Kit Left Side</p> <p>Kit includes:</p> <ul style="list-style-type: none"> • Beacon Bracket Assembly • Work Lamp 8 LED 24W Flood 1920 Lumen • Flexi Beacon 	<p>53857 Beacon Kit</p> <p>Includes: Beacon, Bracket, Wiring, Fuse & Switch</p> 	<p>43592 Beacon Kit T6.120 - T6.175 T6010 - T6090 T7.170 OE Ref: 710762034</p> <p>Includes: Beacon, Cable Connections, Bolt Fixing Set, Beacon Pole, Brackets</p> 
---	---	---

Brackets

<p>51388 Beacon Bracket Spring Loaded</p> 	<p>51388B Bracket Angled for 51388 Beacon Bracket 42 43 61 62 81 82</p> 	<p>43190 Beacon Bracket Assembly Ford 5640 6640 7740 7840 8240 8340 LH</p> <p>43501 Beacon Bracket Assembly Ford 5640 6640 7740 7840 8240 8340 RH</p> 	
<p>3686 Beacon Bracket</p> 	<p>51034 Beacon Bracket Adjustable</p> 	<p>3680 Beacon Plug</p> 	<p>51417 Beacon Bracket John Deere</p> 
<p>51422 Beacon Bracket</p> 	<p>51387 Beacon Bracket</p> 	<p>3687 Beacon Bracket</p> 	<p>51421 Beacon Bracket Adaptor</p> 

Dash Cams

HASSLE FREE INSTALLATION
 – PLUG IN AND YOU'RE READY TO GO

AUTOMATICALLY TURNS ON WITH
 ENGINE START & OFF ON ENGINE STOP

LOOP RECORDING CONTINUOUSLY
 CAPTURES FOOTAGE, CHOOSE TO
 LOCK THE ONES YOU WANT TO KEEP

Batteries Included - Type: RECHARGEABLE



53915
HD DASH CAMERA
1.5" DISPLAY

1080P



53916
HD DASH CAMERA
2.7" DISPLAY

Includes number plate entry for recording Vehicle
 Details Into Each Video

1080P



53917
DASH CAM 2.0" DISPLAY

1080 Pixels GPS Model Full HD & Superior Low Light
 Performance

1080P
FULLHD

LED WORKLAMPS

Up to *Twice* the Lumen Strength of any other LED on the market.

53272

16 LED

3200 LUMENS



53272

Watts	35W Flood
Volts	12/24
Body Material	Aluminium
Conformity	IP67
Size mm	W: 115 H: 115 D: 65

53274

11 LED

2640 LUMENS



53274

Watts	33W Flood
Volts	12/24
Body Material	Aluminium
Conformity	IP68
Size mm	W: 160 H: 100 D: 70

53273

9 LED

2500 LUMENS



53273

Watts	27W Flood
Volts	12/24
Body Material	Aluminium
Conformity	IP67
Size mm	W: 115 H: 115 D: 65

53275

8 LED

3200 LUMENS



53275

Watts	40W Flood
Volts	12/24
Body Material	Aluminium
Conformity	IP68
Size mm	W: 160 H: 100 D: 70

LED WORKLAMPS

Up to *Twice* the Lumen Strength of any other LED on the market.

53413

5 LED

1080 LUMENS



53413	
Watts	15W Flood
Volts	12/24
Body Material	Aluminium
Conformity	
Size mm	W: 110 H: 110 D: 600

53755

5 LED

1000 LUMENS



53413	
Watts	15W Flood
Volts	12/24
Body Material	Aluminium
Conformity	
Size mm	W: 90 H: 90

Cab Roof Lamp John Deere 10 Series

53276

4 LED

960 LUMENS

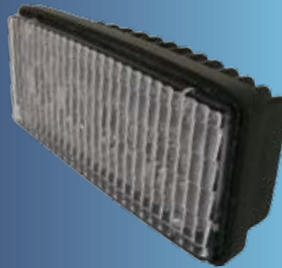

53276	
Watts	12W
Volts	12/24
Body Material	Aluminium
Conformity	IP67
Size mm	W: 138 H: 63 D: 45

53433

8 LED

1920 LUMENS



53433	
Watts	24W Flood
Volts	12/48
Body Material	Aluminium
Conformity	IP67
Size mm	W: 140 H: 95 D: 70

53434

8 LED

1920 LUMENS



53434	
Watts	24W Flood
Body Material	Aluminium
Size mm	W: 150 H: 90 D: 90

Side Mounted

Work Lamps

2356

Work Lamp Small Rubber Body
55 Watt bulb 125mm Diameter
76mm Deep



2773

Work Lamp 50HX



2324

Work Lamp Cab H3
Single Mounted
6"x3.5"



2324N

Work Lamp Cab H3
Single Mounted 6"
x 3.5" **NARROW
BACK**

3179



Work Lamp H3 12V Square

4249



Work Lamp Side Mounted LH
Suits Ford Super Q Cab

4250



Work Lamp Side
Mounted RH

4621



Work Lamp Case

51389



Work Lamp John Deere/Case IHC

51400



Work Lamp John Deere Round H3 12V

Work Lamps

61634

Switch 3000
Front Work
Lamp



61635

Switch 4200
- 8200 Front
Work Lamp



61644

Switch 4200
- 8200 Rear
Work Lamp



7282

Switch Work
Lamp Fiat



62750



Work Lamp Oval 54s
64s 74s Also fits JCB

43061



Work Lamp Ford TD55
TD95

Trailer Lights

Part No.	Description		Lens
1571	Trailer Lamp Round 12v		2586
53098	Trailer Lamp Rubber		53153
3782	Light Guards		
53104	Trailer Lamp Radex 3900 LH		53106
53105	Trailer Lamp Radex 3900 RH		53107
53738	Right Hand Rear Light Radex 2800 6 Function Features: 5 pin quick fit connector socket & marker power socket Functions: Stop/Tail/Indicator/Number Plate/Fog/Reflex Triangle Bulbs included Size 148 x 245 x 60		53408
53739	Left Hand Rear Light Radex 2800		53737

Plug Trailer Harnesses

53115

Plug Trailer Harness Red



53114

Plug Trailer Harness Green



Reverse Lamp

4232

Reversing Lamp
Flush Fit



4 Pin Plug & Loom

53108

4 Pin Plug & Loom for Trailer Lamp Ifor Williams ** To Suit 53104 + 53105 **



Trailer Lights

Accessories

3764



Trailer Board 4ft c/o 10mtr Cable

3767



Trailer Board 4ft c/o 5mtr Cable

LED



53817

Trailer Board 4ft c/o 10m Cable - LED Lamps** 3764 Has Bulb Lamps **

3666

Magnetic Lamp Kit + 7.5mtr Cable with bulbs



53411

Magnetic Combi Lamps 2m x 8m LED

LED



2151

Triangular Reflector Red 153mm (6")

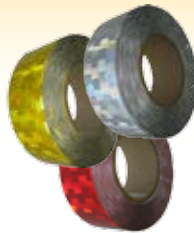

Reflective Conspicuity Tape Clear Rigid Metre

53215 Red

53216 Amber

53217 Clear

53241

Load Resistor



Cables & Core

Part No.	Description	Type	Core	Length	Photo
1355	Suzy Cable c/w Plastic Plug 2.5mtr	Male/Male	7	2.5 M	
53888	Suzy Cable 1.5mtr			1.5mtr	
51032	Suzy Cable 5 mtr Male/Male 7 Core	Male/Male	7	5 M	
51033	Suzy Cable 7 Core Male/Female 7 mtr	Male/Female	7	7 M	
2652	Pre Wired Socket & 1.5 Mtr Cable		7	1.5 M	

EASY FIT WIRING SYSTEM



- Fully waterproof
- Quick & easy installation
- No need for specialist tools

Push-and-seal connectors make installation fast and simple!

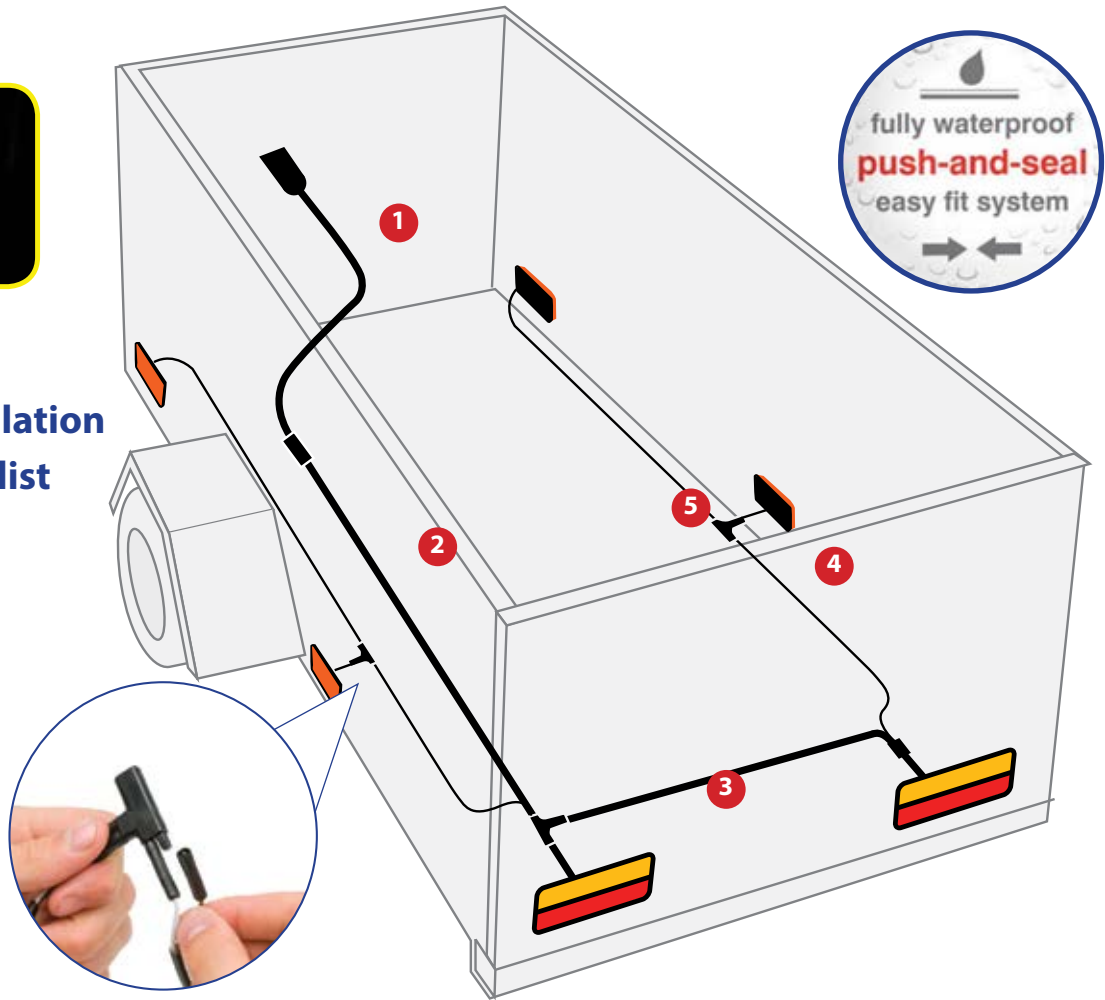

- 1 53248**
Cable 3.2ft / 1 M
c/w Trailer Plug



- 2 Chassis Cables**



Part No.	Length
53251	16 ft / 4.9 M
53252	24ft / 7.3 M
53253	26ft / 8.0 M
53254	40ft / 12 M

- 3 Tail Light to Tail Light Cables**

53249 6.2 ft / 1.9 M

53250 6.8 ft / 2.1 M



- 4 Marker Lamp to Marker Lamp**



Part No.	Length
53243	3.2ft / 1M
53244	6.5ft / 2M
53245	9.8ft/ 3M
53246	13.1ft / 4M

- 5 Marker Lamp To Marker Lamp Cable Connector**

53242 T Piece Connector



51760
P Clips 7.9mm



Rear Lamps LED



51987
Rear Lamp LED 3 Function - Pack of (2) 12volt

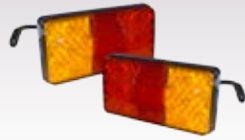

52823
Rear Lamp LED 12V PAIR Small

LEDKIT1

Trailer Basic LED KIT Max Dimensions 23 ft x 7 ft **Kit Includes:**

- Rear Lamp LED 12V PAIR
- Cable 3.2ft / 1 M c/w Trailer Plug
- 24ft / 7.3 M Chassis Cable
- 2.1 Light To Light Cable

53255
Bezel for 51987 C/O Number Plate Lamp



53256

Bezel for 52823 C/O Number Plate Lamp



Marker Lamps LED

Side Marker Lamps with Plugs



Part No.	Size
53257	Amber
53258	Red
53259	White

Angled Rubber Marker Lamps LED

53264 RH
53263 LH



193mm x 169mm x 66mm

53265

Side Marker Lamp Rubber LED C/O Plugs



Marker Lamps

51192

Side Marker Lamp
Mounted Orange



51359

Side Marker Lamp Bracket -
Orange



51194

Side Marker Lamp
Orange



3699

Side Mounted Lamp C/O Holder



1629



Side Marker Lamp 12v (Single
Contact)

1317



** USE 1301 OR 52880 **
Side Marker Lamp Red &
White With Orange

1301

Side Marker Lamp
Red & White



1303

Lens Red for 1301 Side Marker
Lamp



1310

Lens Clear for 1301 Side
Marker Lamp



1649



Side Marker Lamp 12v (Or-
ange Lens)

1302



Front Lamp (Flush
Fitting)

1266



Side Marker Lamp 100

512600



Side Marker Lamp Lens
Amber

1624

Side Marker Lamp 12V 90'



1589

Side Marker Lamp
12v



1329

Eight Way Junction Box



53405

Junction Box 10
Way



3795

Junction Box Six Way



Combination Lamps

1759

Rear Combination Lamp 12v
Tapered PAIR
Lens=2416

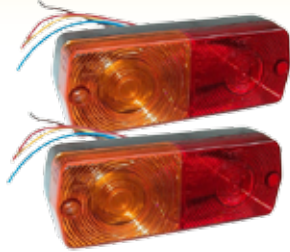

1716

Rear Combination
Lamp 12v Flat PAIR
Lens=2416



2040

Britax



Rear Lamp
Combination - Rice
Trailer

1903

Britax



Rear Lamp Com-
bination

1767



Rear Lamp 12v

3646

Rear Lamp LH (Hella)

Lens=3648

3647

Rear Lamp RH (Hella)

Lens=3649

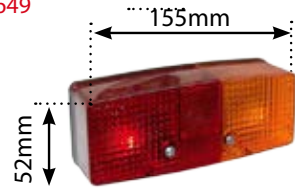

1520

Lamp Lorry LH

1541

Lamp Lorry RH



1538

Lens for 1520 & 1541



62357

Lamp Vintage Type
Round Indicator Type
168 Export Indicator &
Stop & Tail 81.4mm



1350

Lens=1351

Rear Lamp 4
Function



1519

Lamp Rear Indi-
cator



LED LAMPS

Marker Lamps

Side Marker Lamps LED
10/30 Volt

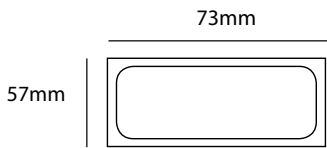

Part No.	Size
51988	Amber
51989	Red
52813	White

Marker Lamps with Brackets
2 Bare Wires 110mm x 64mm x 25mm



Part No.	Size
51927	Amber
51928	Red
51929	White

53099
Side Marker Lamp Trailer LED



53100
Bracket to Suit Side Marker Lamp
53099



LED LAMPS

Marker Lamps - Rubber

52880

Side Marker Lamp Rubber LED 12V

101mm x 82mm x 66mm



Angled Rubber Marker Lamp

51923

RH 12/24 V

51924

LH 12/24 V

193mm x 169mm x 66mm



51922

Side Marker Lamp Rubber LED Small



Combination Lamps

53240

Lamp Trailer LED Stop Tail Indicator



51990

Rear Lamp Round LED 140mm



53622

Rear Lamp Combination LED



53752

Rear Lamp LED 12V Pair Large 200mm x 90mm



SINGLE POLE



3457
Socket Single Pole 12
Volt 15 Amp



6616
Plug Single Pole 12V/15A
for Power Point



51764
Socket Power Outlet
Female 12V/15A



53762
Single Pole Angled Plug



6614
Jack Plug Socket
Single Pole

3 PIN



6613
Socket 3 Pin
- 2 Bolt Fixing



53588
Bracket Cobo Socket
Angled



6626
Plug 3 Pin



53589
Bracket Cobo Socket



6628
Socket 3 Pole
- 4 Bolt Fixing



6644
3 Pin Plug Cover

4 PIN



52612
Plug 4 Pin



52611
Socket 4 Pin



7 PIN



3444
Trailer Socket 7 Pole
Aluminium



3445
Plug 7 Pole Aluminium



51165
Trailer Socket & Plug
7 Pole



1224
Rubber Sealing Gasket 7
Pin Socket

13 PIN



53911
Trailer Socket
Male - 13 Pin



53913
Trailer Socket
Female 13 Pin



53914
7 Pin to 13 Pin
Plastic Socket



53912
13 Pin to 7 Pin
Plastic Socket



Trailer Jockey Wheels & Parts

Trailer Jockey Wheels

<p>51131</p>  <p>Trailer Jockey Wheel - Rotolock 43mm Shaft</p>	<p>51132</p>  <p>Trailer Jockey Wheel 48mm Shaft</p>	<p>53409</p>  <p>Jockey Wheel Economy</p>	<p>53410</p>  <p>Jockey Wheel Autofold</p>
---	--	--	--

51134



Cast Iron Clamp for 51131 43mm

Wheel

51129



Trailer Jockey Wheel for 175 x 45

Handle & Pad

51463



Pad & Handle for Auto Head Reverse Hitch 3500
Autohead = 51458

51303



Trailer Jockey Wheel Serrated 48mm Shaft Rotolock ** Bracket is 53662 **

51130



Trailer Wheel for 210 x 75 for 51303

51154



Locking Handle and Pad

Trailer Jack

51771



Trailer Jack for IFor Williams Trailer

4785



Trailer Safety Chain (16 Link) 1/2"

Trailer Heads

Part Number	Description	Weight	Shaft	Photo
51143	Trailer Head Double Lock - 4 Bolt	1.5 Ton	Bolt on top	
51141	Trailer Head 750kg Old Type	1.7 - 2.7 Ton	Bolt on top	
51268	Trailer Head 2.7 Ton 50mm X 48mm	2.7 Ton	50mm X 48 mm	
51453	Trailer Head for 51458 - 60mm Shaft	3.5 Ton	60mm X 60 mm	
51458	Auto Head Reverse Hitch 3500 Kgs	3.5 Ton	Bolt on top	

51124



Trailer Bellow 3.5 Ton

51123



Grommet Trailer Bellow 1.7 - 2.7 kg for 51457

51625



Coupling for 50mm box section

51159



Trigger & Spring Kit for 51141

Quick Link Chain

Part No.	Size (mm)
53042	6
53043	8
53044	10
53045	12
53046	14



D Shackles & Pins

Part No.	A (mm)	B(mm)
2550	6	11
2551	8	18
2552	10	19
2553	11	20
2554	12	22
2555	16	35
2556	20	38
2557	22	40
2558	25	45

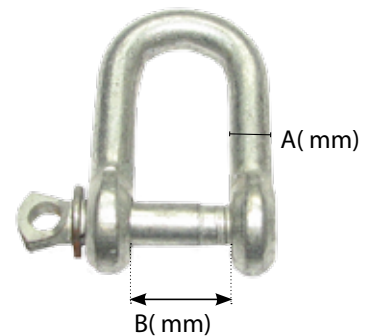

53052



Snaphook & Safety Lock 7 x 70mm

51633



Drawbar Spring Rating 14 Tonne

Hitch & Tow Hitch Parts

2490



Tow Hitch
Double Duty
3500Kg

3595



Trailer Hitch
c/o Mounting
Plate

3811

12' Cranked Towing Ring 30mm Thick



6842

Trailer Hitch 12" Straight
Shank H/D 40mm Th



3788

Trailer Hitch Straight Shank 12" 30mm Thick



Ball Hitch Pins

1403

Hitch Pin and
Ball 1 1/4"

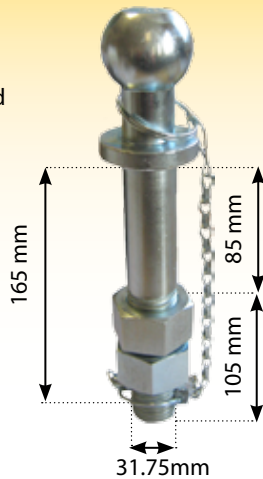

3642

Ball Hitch Pin &
Chain 7 1/2" x 7/8"

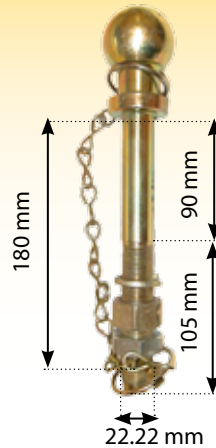

4672

Hitch Ball 7
1/2" x 1" Pin &
Chain

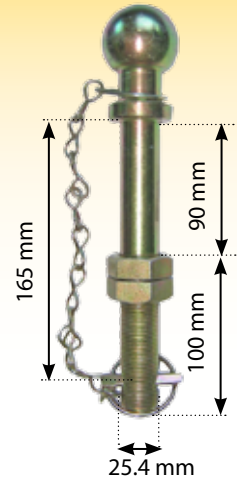

1386

Ball Hitch
max 1250kg

A	B	C
70mm	50mm	10mm

Thread - 7/8 UNF

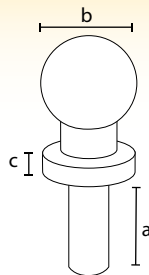

53479

Ball Hitch
max 500kg

A	B	C
72mm	50mm	10mm

Thread - 3/4 UNF

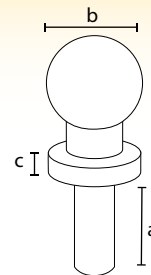

53484

Ball Hitch
max 500kg

A	B	C
50mm	50mm	10mm

Thread - 3/4 UNF

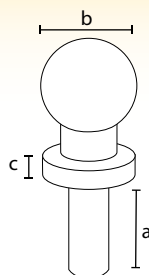

53480

Ball Hitch
max 500kg

A	B	C
70mm	50mm	10mm

Thread - 3/4 UNF

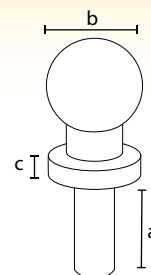

Drawbar Locks

51126



Trailer Lock Barrel

51626



Trailer Anti-theft Lock

51125

Trailer Breakaway Cable 41"



Breakaway Cable

Braked trailers must be fitted with breakaway cable. This cable will apply the hand brake if the trailer becomes detached during towing. It is recommended that it is inspected regularly, and replaced if defects are visible.

51460



Trailer Damper for Bradley Hitch 1.7K

51173



Trailer Damper 2.5 Ton for 51457 Overall length 377mm

51105



Trailer Damper 3.5 Ton for 51458

Drawbar Dampers

Regularly inspect brakes for adjustment to prevent premature failure of damper.

Axle

Hub Caps

Part Number	Description	Hub Size
51429	Hub Cap	72mm
51467	Hub Cap	90mm
51574	Hub Cap	100mm
51428	Hub Cap for F90L410	110mm
51575	Hub Cap New Generation	120mm
51809	Dust Cap Stub Axle= 51452	50mm
51459	Retainer Ring for Stub Axle 35mm 4 Stud	



Stub Axles

51452



Stub Axle U Braked 38mm
100PCD
**** Dust Cap is 51809 ****

51448



Stub Axle 203 x 40 A Rev 4 x
5.5

Bearings

52380

Wheel Bearing lfor Williams
One Piece OD 76mm ID 42mm
Depth 39mm CT HB DP GD LM
LT TA TT

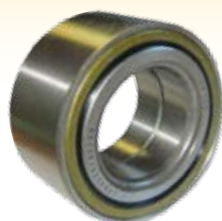

18590/20

Trailer Bearing lfor Williams





Nuts & Bolts

Wheel Nuts

Part No.		Size	
51438		M12	
51455	Conical	M16	
51436	For Stub Axle	M20	
51437	For Braked Stub	M22	
51156		3/8"	

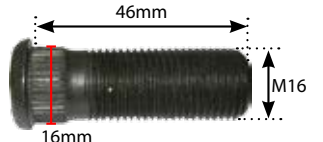
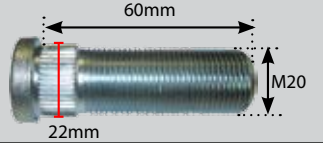
Wheel Studs

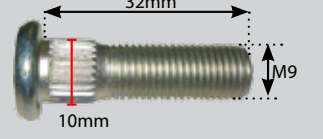
Part No.		Size	
51157		M12	
51158		M16	
51432	For Stub	M20	
51434	For Braked Axle	M22	
51456		3/8"	

51435

Wheel Nut M18
Chrome for Stub
18mm



51433

Wheel Stud for M20
Dual Wheel 20mm

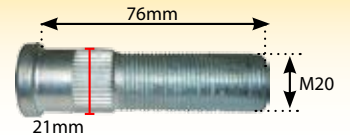

Conical Washer

51935



Conical Washer 20mm

Suspension

Springs

511301



Spring for Williams Single Leaf

** 14mm hole **

511302



Spring for Williams Double Leaf

** 12.5mm hole **

51829



Trailer Spring 3 Leaf

51443



Trailer Spring 4 Leaf

51444



Trailer Spring 5 Leaf

51650



Spring - 7 Leaf

Eye Bracket & Bolt

51446

Leaf Spring Bracket & Bolt Suspension Unit



U Bolt c/w Plate

51445

U Bolt c/w Plate & Nuts 150mm 1/2" UNC

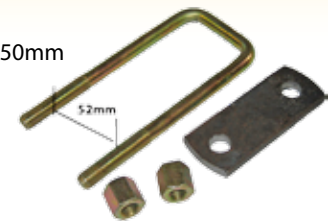

Suspension Units

51135



Trailer 350kg Suspension Unit Per Pair 4" PCD Hubs 4 Stud Grease Nipples

51828

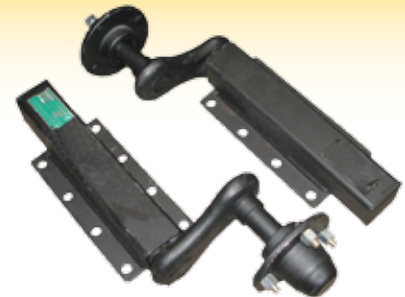

Trailer 750kg Suspension Unit Per Pair 4" PCD Hubs 4 Stud Grease Nipples

Mudguard Flaps

Part No.	Description	Size (mm)	Qty.
2969	Mudguard Flaps	350	Pair
402947	Mudguard Flap Ford 7840 8240 8340 380mm PAIR	380	Pair
2968	Mudguard Flaps	400	Pair
402948	Mudguard Flaps. Ford 7840 8240 8340	470 480	Pair
2959	Mudguard Flaps	540	Pair
2960	Mudguard Flaps	600	Pair

1488



Mudguard Trailer Tandem 8" x 68" - PAIR

62811

Mudguard Kit Universal 4WD 400mm Flaps ** 63136 is Adaptor Plate **



1496

Mudguard Trailer 13" Wheel - PAIR



Wheels

51442



Wheel Rim c/w 165 x 13 Tyre (4 Stud) 5.5 pcd

51635



Wheel Rim Complete & Tyre 13" 6.5 pcd 195-50-13 lfor Williams trailer (underbody) - 5 Stud

53103



Wheel Rim Complete c/w Tyre 145 X 10 Suits 51135 & 51828



Trailer Parts

Spring Bolts

53657	Ø 10mm
53658	Ø 12mm
53659	Ø 16mm
53660	Ø 19mm
53661	Ø 22mm



2547

Spring Bolt
Small

Ø 13mm



53226

D Ring 1/2" Forged



53088

Lock Rope Ring
Recessed



3867

Cattle Trailer Fastener



1583

Antiluce



4428
Antiluce



4030

Trailer Side Board Fastener



2496

Antiluce





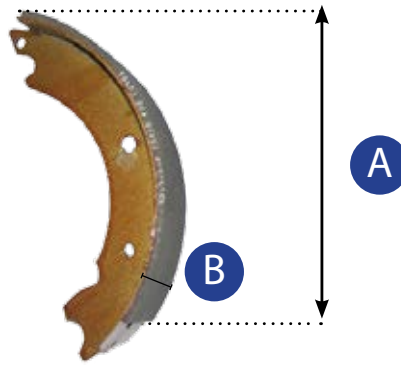

3804

Weld On Antiluce Fastener

Brake Shoes



Part Number	Description	Qty	A	B	Photo
51100	Brake Shoe for Ifor Williams 6"	Set of 4	170mm	50mm	
51295	Brake Shoe Set 8" Suits auto reverse system	4 Pieces 2 Pairs	200mm	50mm	
51171	Brake Shoe (Pair)	4 Pieces 2 Pairs	203mm	40mm	
51294	Brake Shoe Set 10"	4 Pieces 2 pairs	250mm	40mm	

Brake Cables

51462 Trailer Brake Cable 1200mm



51638



Cable Shell

51167 Brake Cable 1100mm Threaded



53081



Trailer Brake Cable
Threaded 1800mm

51170 Brake Cable 1600mm Threaded



51296 Trailer Brake Cable 1200mm Threaded



Brake Ram Parts

4611



Trailer Brake Ram Cylinder 25mm
285mm centres 70mm Stroke
with Internal Return Spring

1545



Trailer Brake Ram c/w Bracket

Brake Springs & Kits

51299

Backing Plate Spring 5cm



52833

Backing Plate Spring Kit 4
Stud Hub



51297

Spring Knott 8" Long Hook



51302

Spring Knott 8" **Short Hook**



52834

Brake Spring Kit 5
Stud Hub

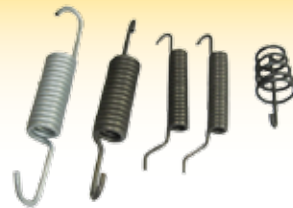

53102

Spring Lower Link Restrainer
Min 17.5" 400mm Max 30" 765mm

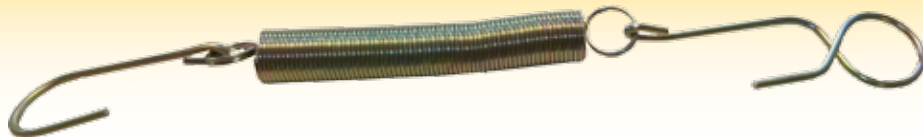

Decals

53680
Decal
30kmph



53681
Decal
40kmph



53682
Decal
50kmph



53683
Decal
60kmph



Straps And Winches

5077

Cargo Strap 5 Ton
x 8 mtr



5059

Cargo Strap 5
Ton x 10 mtr



5099

Cargo Strap 5
Ton x 12 mtr



53372

Cargo Strap 3 Ton x 5 mtr



51910

Engine Sling 2 Ton x 2 Metre
Web Type



51911

Engine Sling 2 Ton x 3 Metre
Web Type



51912

Engine Sling 2 Ton x 4 Metre
Web Type



51913

Engine Sling 3 Ton x 5 Metre
Web Type



Brake & Clutch Fluid

2448



Brake Hydraulic Oil
1Ltr LHM Mineral

2445



Brake & Clutch Fluid
Dot4 1 Ltr

2355



Brake & Clutch Fluid
5 Ltr.

4611



Trailer Brake Ram Cylinder 25mm
285mm centres 70mm Stroke
with Internal Return Spring

1545



Trailer Brake Ram
c/w Bracket

51236



Spring for 1545
Brake Ram

1353

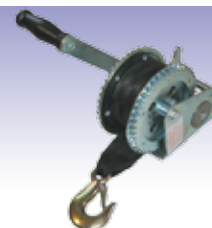

Strap Winch 500Kg (6MTS
STRAP)

Valves

61254

Trailer Brake Valve Repair Kit - 16mm SealFits 300
600 3000 5400 6100 6200 8100





Date:.....

No. of Pages:.....

Name of the Rep.....

A/C Number:.....

From:.....

e-mail.....

Phone No.:.....

Fax No.:.....

Please quote for the following parts - Quotation Number :

I wish to confirm the following order on Quotation Number:

Please supply the following parts:

Please photocopy this page

Please do not remove this page

Qty	Part No.	Description	Unit Price
1.			
2.			
3.			
4.			
5.			
6.			
7.			
8.			
9.			
10.			
11.			
12.			
13.			
14.			
15.			
16.			
17.			
18.			
19.			
20.			
21.			
22.			
23.			
24.			

Comments: _____

Customer Signature: _____ **Rep's Signature:** _____

Tel No: + 353 44 934 1638

e-mail: info@qtponline.com, www.qtponline.com

Page of

Bulbs

H1 Halogen

3102 12V h1 55w Bulb
3550 24V h1 55w Bulb



H3 Plough

1003 12V H3 55w Bulb
3678 24V H3 70w Bulb



H4 Halogen

4324 12V H4 80/100W Bulb
3909 12V h4 60/55W Bulb
1111 12V h4 60/55W Bulb



H7

51715 Bulb H7 55W



1413



Bulb 12v 21/5w Stop & Tail

1412



Bulb 12v 21w Indicator

1360



Bulb 12v 50/40w Double Contact P/F

4205



Bulb 12v 21/5w Stop/Rear Old Type Ford Q Cab

53424

Bulb Bayonet 10W 12V



3586

Bulb 12v 5w Double Contact S/F



4499

Bulb 12v 21w Double Contact



1361 Bulb 12v 5w Single Contact

3160 Bulb 24v 5w Double Contact S.F



59805

Bulb 12v 50w John Deere 6000 & Ford



1316

Bulb 12v 45/40W



53648

Bulb 12V 55W H4 Halogen 120% Pair



3196

Bulb 12v 3w Capless

4128 Bulb 12v 1.2w Capless



1971

Bulb Holder Single Contact



1965

Bulb Holder Double Contact

4657

12V 10W Bulb (30mm)

1359

12 V 5W Bulb (38 Mm)



1347

Bulb 12v 4w

4509

Bulb 12v 2w



2076B

Bulb 12v For Hand Lamp



41841

Bulb Ford TS100A Work Lamp



61573

Bulb 300's Dash Light Panel



61135

Bulb 12v 2w 4200 6100 8100 Philips



61661

Bulb 3000 3100 3600 Dash Light



7060

Bulb Fiat Rear Mounted Work Lamp



Bulbs

<p>H1</p>  <p>NEW</p> <p>53645 Bulb 12V 55W H1 Halogen 80% Pair</p> <p>80% Brighter</p>	<p>H4</p>  <p>NEW</p> <p>53647 Bulb 12V 55W H4 Halogen 80% Pair</p> <p>80% Brighter</p>	<p>H7</p>  <p>NEW</p> <p>53649 Bulb 12V 55W H7 Halogen 80% Pair</p> <p>80% Brighter</p>
 <p>NEW</p> <p>53646 Bulb 12V 55W H1 Halogen 120% Pair</p> <p>120% Brighter</p>	 <p>NEW</p> <p>53648 Bulb 12V 55W H4 Halogen 120% Pair</p> <p>120% Brighter</p>	 <p>NEW</p> <p>53650 Bulb 12V 55W H7 Halogen 120% Pair</p> <p>120% Brighter</p>

Electrical Cable

Part No.	Description	Unit	View
1810R	4.8mm x 2.4mm Heat Shrink	20 mtr roll	
1811	6.4mm x 3.2mm Heat Shrink	mtr	
1811R	6.4mm x 3.2mm Heat Shrink	15 mtr roll	
1812	9.5mm x 4.8mm Heat Shrink	mtr	
1812R	9.5mm x 4.8mm Heat Shrink	15 mtr roll	
1813R	12.7mm X 6.4mm Heat Shrink	10 mtr roll	
1814	19.1mm x 9.5mm Heat Shrink	mtr	
1814R	19.1mm x 9.5mm Heat Shrink	10 mtr	
1141	Blue Heat Shrink Butts (Suitable for Cables 1.5mm ² - 2.0mm ²)		
1142	Yellow Heat Shrink Butts (Suitable for Cables 3.0mm ² - 6.0mm ²)		

Electrical Cable

1 Core Cable



Cross Section

Part No	Thickness (mm)	Length (Mtr)	Colour
51161BK	4.5	10	Black
51161	4.5	10	Red
51161Y	4.5	10	Yellow
3380BK	4.5	30	Black
3380BR	4.5	30	Brown
3380R	4.5	30	Red
3380Y	4.5	30	Yellow

Clips



- 51758 P Clips 4.8mm
- 51759 P Clips 6.4mm
- 51760 P Clips 7.9mm
- 51761 P Clips 9.5mm
- 51837 P Clips (pack of 60)

2 Core Cable (Round Twins)



Cross Section

Part No	Thickness (mm)	Length (Mtr)	Colour
51162	2 x 1	10	Black Round
51963	2 x 4.5	30	Black Round
51964	2 x 4.5	10	Black Round

Armour Cables



- 62691
Armour Cable TE20 - 10 Mtr Roll
Inner Diameter 14mm

2 Core Cable (Flat Twins)



Cross Section

Part No	Thickness (mm)	Length (Mtr)	Colour
3637R	2 x 2	30	Black Flat
51961	2 x 4.5	10	Black Flat
51962	2 x 4.5	30	Black Flat

Wire Strippers



- 3640
Wire Stripper

3 Core Cable

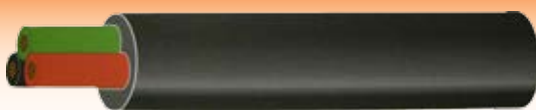

Cross Section

Part No	Thickness (mm)	Length (Mtr)	Colour
51845	3 x 3	10	Black

Electrical Cable

4 Core Cable



Cross Section

Part No	Thickness (mm)	Length (Mtr)	Colour
2629R	4 x 1	30	Black
2629M	4 x 1	100	Black
51846	4 x 3	10	Black

7 Core Cable



Cross Section

Part No	Thickness (mm)	Length (Mtr)	Colour
1053R	6 x 1 1 x 2	30	Black
51164	6 x 1 1 x 2	10	Black

13 Core Cable

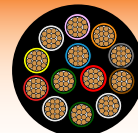

Cross Section

Part No	Thickness (mm)	Length (Mtr)	Colour
53909	8 x 1.5 5x 2.5	10	Black
53910	8 x 1.5 5x 2.5	30	Black

Battery Cable



Part No	Thickness (mm)	Length (Mtr)	Colour
2631	50	10	Black
2636	50	10	Red

Cable Connectors

4175



Connection 6.3 x 0.8 Female

4176



Connection 6.3 x 0.8 Male

4177



Connection 1 Way Female

4178

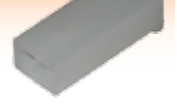

Connection 1 Way Male

4179



Connection 2 Way Female

4180



Connection 2 Way Male

4181



Connection 2 Way Female

4182



Connection 2 Way Male

4183



Connection 3 Way Female

4184



Connection 3 Way Male

4185



Connection 4 Way Female

4186

























Connection 4 Way Male



2633 Cable Connection Strip 2.5amp Flexy
1445 Cable Connection Strip 5amp Flexy
2634 15 amp Flexi Cable Connector Strip

Terminals

<p>1933 Suitable for cables 3.0 mm² - 6.0 mm²</p>  <p>Terminal 9.5mm Female Push On</p>	<p>2166</p>  <p>Yellow Round Terminal M6</p>	<p>2167</p>  <p>Yellow Round Terminal M8</p>	<p>2168</p>  <p>Yellow Round Terminal M10</p>	
<p>1110</p>  <p>Yellow Piggy Back Terminal 6.3mm</p>	<p>2632</p>  <p>Terminal 9.5mm Female Pre-Insulated</p>	<p>2164 Suitable for cables 2.5 mm² - 6.0 mm²</p>  <p>Spade Terminal - Yellow</p>	<p>2209</p>  <p>Spade Terminal H/D Small Insulated</p>	
<p>3381</p>  <p>Spade Terminal - Blue Male</p>	<p>3542</p>  <p>Spade Terminal - Blue Medium</p>	<p>2163</p>  <p>Spade Terminal - Blue Suitable for 1.0 - 2.5 mm Cable</p>	<p>1107</p>  <p>6.3mm Blue Piggy Back Terminal</p>	
<p>3716 Suitable for cables 1.5 mm² - 2.5 mm²</p>  <p>Small Blue Insulated Spade Terminal Female 100 in a box</p>	<p>3628</p>  <p>Terminal 5mm Blue Bullet</p>	<p>3382</p>  <p>Blue Round Terminal M6</p>	<p>3383 Suitable for cables 1.0 mm² - 2.5 mm²</p>  <p>Round Terminal M10</p>	
<p>4514</p>  <p>Male Bullet Terminal</p>	<p>4560</p>  <p>Red Female Bullet Terminal</p>	<p>3891 Suitable for cables 0.25 mm² - 1.0 mm²</p>  <p>Spade Terminal Red Male 6.3 x 0.8 mm</p>	<p>4559</p>  <p>Red Male Bullet Terminal</p>	<p>1102 Suitable for cables 0.5 mm² - 1.5 mm²</p>  <p>6.3mm Red Piggy Back Terminal</p>
<p>52903</p>  <p>Pre Insulated Terminal Kit 160pcs</p>		<p>52902</p>  <p>Pre Insulated Terminal Kit 260pcs</p>		

Connectors

<p>1318</p>  <p>Blue Scotch Hook Connector</p>	<p>53116</p>  <p>Connector Super Seal 2 Way Female Kit</p>	<p>53117</p>  <p>Connector Super Seal 2 Way Male Kit</p>
--	--	--

Radio Fuses



1074	1 Amp	Radio Fuse
1075	2 Amp	Radio Fuse
1026	4 Amp	Radio Fuse
1087	5 Amp	Radio Fuse
1099	10 Amp	Radio Fuse

Glass Fuses



2928	10 Amp	Glass Fuse
2929	15 Amp	Glass Fuse
2640	20 Amp	Glass Fuse
1939	25 Amp	Glass Fuse
2641	30 Amp	Glass Fuse
2642	35 Amp	Glass Fuse
2644	50 Amp	Glass Fuse

Ceramic Fuses



1935	8 Amp	Ceramic Fuse
1357	16 Amp	Ceramic Fuse
1388	25 Amp	Ceramic Fuse

Glass Fuse- Pack

51285



Fuses Assorted Pack
Glass (25 pcs)

Strip Fuses

52923	30 Amp	
52924	40 Amp	
52925	50 Amp	
52926	60 Amp	
52927	80 Amp	

Mega Fuses

52929	100 Amp	Yellow	
52930	125 Amp	Green	
52931	150 Amp	Orange	
52932	175 Amp	White	
52933	200 Amp	Blue	
52934	225 Amp	Brown	
52935	250 Amp	Pink	

Blade Fuses

2156	7.5 amp	Brown	
2159	10 amp	Red	
2174	15 amp	Blue	
2160	20 amp	Yellow	
3612	30 amp	Green	

52900

Fuse Mini Blade
Tool Kit 90pcs



51498

Fuses Box of 12
Assorted



53598

Fuse Blade & Tool Kit
93pcs
Includes Tester and
Removal Tool



51047

Fuses 10 per pack
Assortment



Fuse Holders

3639



Fuse

922108



Fuse Holder Inline + 8A
Ceramic Fuse

1072



Fuse Holder c/w
Wiring

3635



Fuseblade
Extractor/Tester

2152



Fuseholder
20amp Blade

51426



Fuse Holder & Wire Black

3613



Fuse Holder Blade Splash Proof

3638



Fuse Holder

2154



Fuseholder 2 x
6.3mm Blade

2155



Fuseholder In Line Wire
Holder

2208



Fuseholder 6.3mm Blade

Cable Ties

51838 Cable Clips Nylon
5MM Pack of 50



51857 Cable Clips Nylon Medium 8MM

51856 Cable Clips Nylon Large 14mm
Pack of 50

3717
Cable Ties 140 x 3.6mm



1238
295 x 4.8mm

3538
370 x 4.8mm

2646
370 x 7.6mm

1841
Insulating Tape
20mtr. 19mm

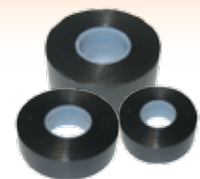

1840
Insulating Tape
33mtr.19mm Black

1842
Insulating Tape 20mtr.
25mm Black

Fuseboxes

51981



Fusebox 4 Way Complete

2157



Fusebox 6 Way Complete

3703



Fusebox 6 Bank



53763
Fusebox With Cover
Negative Busbar

62590



Fusebox 8 Way

7291



Fusebox 110-90 12 Way

2158



Fusebox 265 275 290
8 Way Complete

2161



Fusebox 8 Way Complete

62704



Fusebox 13 Way

62712



Fusebox 14 Way

62713



Fusebox 15 Way

Assembly Cables

52906

Cable Assy 1 x Female
2 x Male Yellow



Batteries & Accessories

59337

VARTA



12V 110AH **920Amp**
John Deere 4 Cyl Case
MX Ford 2000 3000

1567



663 **680Amp** 110AH
L=345 H=210 W=165

1459



Ford Type 622 **680Amp**
130AH
L=510 H=185 W=215

1334



069 **630Amp** 70Ah
L=255 H=200 W=165

2566



Type 067TE **640Amp**
70AH
L=270 H=175 W=165

62793



G3 **800 Amp**

1568



655 High **720Amp**
125AH
L=345 H=255 W=165

1389



Battery
120AH **1000Amp**

1387



Battery Rubber
12V **73Amp** 20hr

YUASA

59354



12V **1000Amp**
170AH John Deere
6 Cyl Valmet

3117



Fiat Type **800Amp**
140AH
L=410 H=200 W=185

Batteries & Accessories

61112

Battery Clamp
165 168 188
Small - PAIR



884789

Battery Retaining Clamp 135



51403

Battery Clamp 41cm Long



41567

Battery Cover Lucas - Small Original Type



62414

Battery Tray 20D & 35 4 Cylinder



2169

Black Clamp (500 Amps)
(35/50mm Cable)



2170

Red Clamp (500 Amps)
(35/50mm Cable)



2924

Clamp 300 Amps 50mm
Cable Black



2925

Clamp 300 Amps 50mm
Cable Red



51811

Crocodile Clamp
Small



4554

Black Clamp - Small 220 Amps
16mm Cable



2654

Jump Lead 5mtr Cond.
Size 20mm

2655

Jump Lead 5mtr Cond.
Size 35mm

2656

Jump Lead 5mtr Cond.
Size 50mm



3452

Hella Circuit Tester



Batteries & Accessories

Battery Cables

Red Battery Cables (+) (50 mm)



Part No	Length(mm)
51600	450
3528	900
1151	1100
51604	1300
51602	2000

Black Battery Cables (-) (50 mm)



Part No	Length(mm)
51601	450
3529	900
1152	1100
51605	1300
51603	2000

51598

Battery Strap 400mm c/o Terminals



51954

Battery Strap 400mm - No Terminals



Terminals



40mm ² 50mm ² Cable	
8mm Hole	10mm Hole
53773 Swage On	2811 Swage On
53771 Open End	53770 Open End

60mm ² 70mm ² Cable	
8mm Hole	10mm Hole
53772 Swage On	51010 Swage On
2926 Open End	2927 Open End

2636

Battery Cable
10 Mtr Roll
50mm
Sold By Roll.



2631

Battery Cable
10 Mtr Roll
50mm
Sold By Roll.



Batteries & Accessories

Battery Terminals

52936	Battery Terminal Stud & Nut 17x10mm	Positive
52937	Battery Terminal Stud & Nut 17x10mm	Negative
52938	Battery Terminal Stud & Nut 30x10mm	Positive
52939	Battery Terminal Stud & Nut 30x10mm	Negative
1013	Battery Terminal	Negative
1014	Battery Terminal	Positive

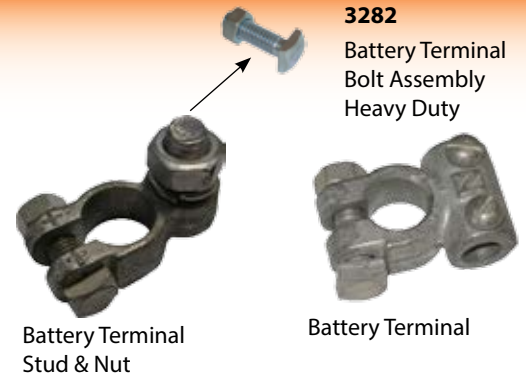

53167

Battery Terminal Cut Off With Fuse



53166

Battery Terminal Cut Off



3875
Cut Off Isolation Switch Amp Heavy Duty



3875E
Cut Off Isolation Switch Amp Heavy Duty



51984
Cut Off Isolation Switch Battery Emergency



2303
Cut Off Isolation Switch Lucas - Up to 165



2923
Cut Off Isolation Switch - Heavy Duty

53296

Rubber Cover Angled Red **Small**



53230

Rubber Cover Angled Red **Medium**



53232

Rubber Cover Angled Red **Large**



53297

Rubber Cover Angled Black **Small**



53231

Rubber Cover Angled Black **Medium**



53233

Rubber Cover Angled Black **Large**



2647

Battery Terminal Cover Black LH Black



2649

Battery Terminal Cover RH Black



2648

Battery Terminal Cover LH Red



2650

Battery Terminal Cover RH Red (+ve)



Relays

1106

Relay Flasher Unit Duncan Cab
21W X 4



1341

Solenoid Relay 1940 S 390 40
amp with Loom

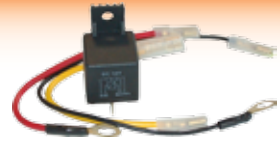

51046

Twin Relay



4680

Relay 12v
Normally Open
30A 4 Pin



4681

Relay 12v
Normally Open
40A - 4 Pin
Starter Relay CX
McCormick



4682

Relay 12v
Changeover
40A - 5 Pin



4692

Relay 12v Changeover
150A - 4 Pin
Normally Open 50HX
Starter Relay



4556

Relay 12v Nor-
mally Open 40A

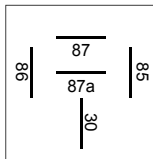

51599

Relay 12v
Head Lamp
Main Beam &
Dim CX MX
Maxxum



4561

Flasher Unit
Electronic



Push Button Switches

51897

Push Button Switch
Plastic c/w M22 Insu-
lated Screw Terminals



51899

Push Button Switch C/W
M22 Insulated Spade
Terminals



51969

Push Button Switch
Waterproof Heavy Duty
M19 Steel Screw Terminals



51902

Push Button Switch
Brass Fully Insulated
C/W M22 Insulated
Screw Terminals



51900

Push Button Switch
Fully Insulated M22
Insulated Spade
Terminals



2098

Starter Push Button
Switch M22 Plastic Screw
Terminals



51901

Push Button Switch Fully
Insulated C/W Screw
M22 Insulated Screw
Terminals



2610

Switch Push Button
20amp Heavy Duty
- M25 Plastic Screw
Terminals



1200

Switch Push Button -
Heavy Duty M15 Steel
Screw Terminals



1483C

Push Button
Switch (Horn) c/w
Rubber Cap M22
Insulated Screw
Terminals



1483

Push Button Switch
(Horn) M22 Steel
Screw Terminals



51968

Switch Push Button Red
M19 Steel Spade Termi-
nals



51967

Switch Push But-
ton Black
M19 Steel Spade
Terminals



Switches

51004



Steering Column
Indicator Switch

51980

Handle Bar
Switch Quad



51529

Switch 3 Pin Pull
to Start



4878

Switch For Fan -
3 Position



1309

Switch Push & Pull
** Long Stem **



3824

Switch - Push/
Pull On/Off



51185

Pull Switch
c/o light



51985

Flasher Unit
Adjustable
12V



1710

Flasher Unit &
Indicator Switch



2703

Indicator Switch
135 148 165 188
240 285 290 50
50B 50H 50HX
Ford 1000



52917

Starter Push But-
ton Switch



4196

Indicator Switch
- c/o Light
Green



62831

Ignition Switch 6245
6255 6260 6265 6270
6280 6290 8210 8220
8240 8250 8260 8270
8280 5425 5435 5445
5455 5460 5465 5470
5475 5480 6445



1259 Lamp Warning Red 12v 4W for Alternator **
1312 is 1.2W Lamp **



Rocker Switches On/Off Maxi

3512 Plain



3513 Green



3514 Blue



Rocker Switches 16Amp

2637

Blue On/Off 16amp

2619

Red On/Off 16amp

2639

Green On/Off 16amp



1822



Indicator Switch
600 & Landini

51773



Brake Light Switch **
Off when pressed **

51772

Brake Light Switch
Ford 3000 5000
Silver Contact (Super
Q Cab)
** ON when press
**



62028

Door Lamp
Switch



3662

Brake Light Switch 200 500



Switches

Deutz, Fendt, Hurliman, Lamborghini, Renault, Same



53631
Switch Light Work Deutz
Fahr Fendt Hurliman
Lamborghini Renault SAME
Push Push



53632
Switch Light Rear Side
Fendt Hurliman Landini
Renault SAME Push Push



53633
Switch Light Front Side
Hurliman Lamborghini
SAME



52278
Switch PTO Command Case
IH Deutz Fendt Hurliman
Lamborghini SAME Push
Release



680085
Switch PTO Command
Fendt Deutz Renault Push
Push



53638
Switch Hazard Hurliman
Lamborghini SAME Renault
Push Push



53634
Switch Beacon Hurliman
Lamborghini Renault SAME
Push Push



53637
Switch Engine Stop Hurliman
Lamborghini SAME
Push Push

Deutz



53626
Switch Side Rear Light DX DX4
DX6 DX7 Series Push Push



53630
Switch Light Front Side Deutz
Agroprima Agroextra DX DX3
DX4 DX6 DX7 Push Push



53627
Switch Light Parking Deutz
Valmet Fendt Farmer 200 300
Favorit 600 Push Push

Deutz, Valmet, Fendt



52282
Bulb Housing Case CS100 CS110 CS120 CS130
CS150 CS48 CS52 CS58 CS63 CS68 CS75 CS78 CS86
CS94 9100M 9105 9115 9125 9145 M9078 M9086



52281
Switch Housing Case CS100 CS110 CS120 CS130
CS150 CS48 CS52 CS58 CS63 CS68 CS75 CS78 CS86
CS94 9100M 9105 9115 9125 9145 M9078 M9086

Switches

Renault



780224
Switch Hazard Renault
Push Push



780223
Switch Starter Renault Push
Release

Fendt



53629
Switch Beacon Fendt
Push Push



680084
Switch Light Work Fendt
520 522 524 Case C42 C48
C55 C64 C70
Push Push

Valmet, Same, Fendt



53639
Switch Lift & Lower Valmet 505 605 705 805
900 255 355 455 555 655 755 855 365 465 565
665 865 A75 A85 A95 Fendt SAME

Case, Steyr



52279
Switch Hoisting Up Case CS100 CS110 CS120 CS150 CS48
CS52 CS58 CS63 CS68 CS75 CS78 CS86 CS94 CS48 Steyr
9100M 9105 9115 9125 9145

General Purpose



53635
Switch PTO Command Push
Push



53641
Switch PTO Command Push
Release



53628
Switch PTO Command
Push Push



52277
Switch Hazard Massey Ferguson
Case IH Deutz Fendt Steyr Push
Push











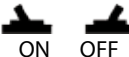
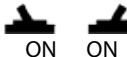

53640
Switch Horn Push Release

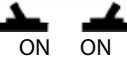

52280
Switch Horn Push Release Fer-
guson 3000 3600 Push Release

Switches

 <p>51035 Switch On/Off Narrow</p> 	 <p>51042 Switch On/Off/ On 3 Pole</p> 	 <p>51036 Switch On/Off 3 Pole Red Light</p> 	
 <p>51037 Switch On/On 3 Pole</p> 	 <p>51038 Switch On/On 6 Pole</p> 	 <p>51041 Switch On/Off/ On 6 Pole</p> 	
 <p>51039 Switch On/On 4 Pole</p> 	 <p>51040 Switch On/Off/ Hold On 3 Pole</p> 	 <p>53420 Switch Hold On/Off/ Hold On 3 Pole</p> 	
		<p>53690 Toggle Switch Hold On/Off/Hold On</p>	
<p>51044</p>  <p>Switch Cover</p>	<p>1455</p>  <p>Toggle Switch On Off 20 Amp</p>	<p>2294</p>  <p>Toggle Switch On/ Off/On 20amp</p>	<p>2618</p>  <p>Switch Toggle On/ Off/On 20 Amp Heavy Duty</p>

Rocker Switch Panels

<p>3520</p>  <p>Rocker Switch Panel Single Hole</p>	<p>3519</p>  <p>Rocker Switch Panel 2 Hole</p>	<p>3521</p>  <p>Rocker Switch Panel 3 Hole</p>
---	--	--

Fan Cab Blowers

52753



Fan Cab Blower Case Magnum MX STX Also fits New Holland T8 T9 TG

52754



Fan Cab Blower Case XL Maxxum Maxxum 5120 5130 5140 5150

52751



Fan Cab Blower Case CX MX CX 50 60 70 80 90 100

62780

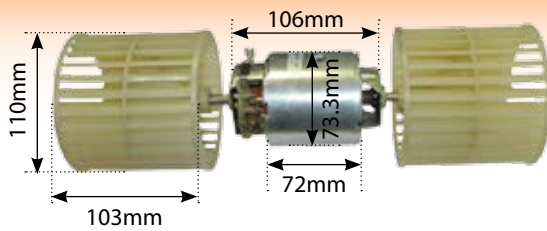

Fan Cab Blower 3000 6100 5400 6200 8100 Also fits 8200

62777



Fan Cab Blower 300

42111



Cab Blower Ford 40 60 TM TS Also fits Case JX MXM

42113



Fan Cab Blower Ford TS T6 T7 Maxxum 100 110 115 120 130 140 MXU MXU 100 110 115 125 130 135

58690



Fan Cab Blower John Deere 40 50 10 SG2 Cab 11 Series Combine SG2 Cab

42214

Blower Resistor Ford 40 60 TM TS Suits 42111

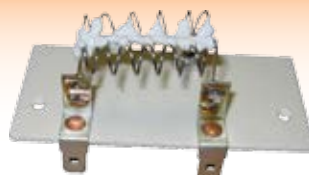

42215



Motor for 42111 TM Blower

53132



Ducting 10 Metre Roll Air Conditioning

Gauges

51213

Gauge Temperature c/o
2.5 mtr Flex



3417

Gauge Water Temperature
Electric Calibra



USB SOCKET



53785

USB Sockets Dash
Mounted

3458

Oil Pressure Sender Unit



3409

Oil Pressure Sender Ford
8 Bar



Temperature Senders

3437

Temperature Sender CASE IH
4210/20/30/40 485, XL/584/685/695,XL/
784/785,XL/885,XL/895,
Thread 1/2" x 14 NPFT



3456

Temperature Sender 5/8" 18
UNI - 42mm





Date:.....

No. of Pages:.....

Name of the Rep.....

A/C Number:.....

From:.....

e-mail.....

Phone No.:.....

Fax No.:.....

Please quote for the following parts - Quotation Number :

I wish to confirm the following order on Quotation Number:

Please supply the following parts:

Please photocopy this page

Please do not remove this page

	Qty	Part No.	Description	Unit Price
1.				
2.				
3.				
4.				
5.				
6.				
7.				
8.				
9.				
10.				
11.				
12.				
13.				
14.				
15.				
16.				
17.				
18.				
19.				
20.				
21.				
22.				
23.				
24.				

Comments: _____

Customer Signature: _____ **Rep's Signature:** _____

Tel No: + 353 44 934 1638

e-mail: info@qtponline.com, www.qtponline.com

Page of

TRACTOR

PAINT

Hand brush or spray
Hardens to an OEM Finish
No colour variance

PLEASE NOTE:
Use QTP Thinners Only.
Follow directions on tin.

For a Professional Finish

1 Choose Paint
Spray or Brush

Choose
From a wide
range of colours

2 TR1488
1 Ltr Thinners

Mixing Ratio
Paint :Thinners
9:1 or 10:1



3 TR7000
1 Ltr Clear
Lacquer

Tough
Durable &
easy to use



MASSEY FERGUSON

- 1200TR** 35 4 Cylinder Gold
- TR1001** 35 4 Cylinder Red
- TR1180** 35X Ferguson Grey
- TR1187** Massey Ferguson Red
- TR1181** MF 100s Silver Mist
- TR1265** Massey Ferguson Flint Grey
- TR1399** Stoneleigh Grey
- TR1116** Transmission Brown / Charcoal Grey
- TR1000** 42 Series Chassis Black
- TR1002** Massey Ferguson 42 54 Red (New Red)
- TR1004** 42 Series Silver Mist
- TR1179** Smoke Grey
- TR1222** NH Driveline Grey - New Cab
- TR1225** Massey Ferguson Light Grey Pain
- 1191TR** Light Grey

RENAULT

- TR6615** Renault Grey
- TR6611** Renault Orange

SAME

- TR5501** Same Blue

FORD

- TR2440** Fordson Empire Blue
- TR3488** Fordson Orange
- TR1182** Ford Tractor Blue
- 6616TR** New Holland Chassis Grey
- TR1071** Ford Grey
- TR1196** New Holland Ford Blue
- TR1221** New Holland Grey White for Wheels

FIAT

- TR3130** Fiat Brown
- 3487TR** Fiat Opal White
- 4188TR** Fiat Terracotta Brown
- TR3131** Fiat Orange
- TR3132** Fiat Cream

JOHN DEERE

- TR1162** John Deere Green
- TR2134** John Deere Yellow

LANDINI

- TR1065** Landini Blue

FENDT

- TR1060** Fendt Green

53208
Grey Primer
Wheel Spray
500ml Can



53207
Silver Paint
Wheel Spray
500ml Can



53210
Black Paint
Wheel Spray
500ml Can



53209
High Gloss
Black Paint
Wheel Spray
500ml Can



TRACTOR

PAINT

Hand brush or spray
Hardens to an OEM Finish
No colour variance

PLEASE NOTE:
Use QTP Thinners Only.
Follow directions on tin.

For a Professional Finish



IHC/DAVID BROWN

- TR1163** IHC Off-White Wheels
- TR1231** International Red
- TR4703** Case/IHC Red New Red
- TR3489** David Brown Hunter Pink
- TR1184** David Brown Orchid White
- TR1184A** David Brown Power Red

Deutz

- TR6617** Deuta Green
- TR6618** Deuta Green

ZETOR

- TR1193** Zetor Grey
- TR1183** Zetor Red
- TR1189** Zetor Chassis Green

LEYLAND

- TR1190** Leyland Light Blue
- TR1190A** IHC / Leyland Dark Blue

WHITE/BLACK

- TR2175** Matt Black
- TR1109** Gloss Black
- TR1420** White

INDUSTRIAL

- TR1520** Old Hitachi Orange
- TR1003** New Hitachi Zaxis Orange
- TR1185** Industrial Yellow
- TR1198** New JCB Yellow
- TR1115** New Holland Clayson Yellow
- TR1160** New Ford Yellow
- TR1192** Komatsu Yellow
- TR1194** New Holland Yellow
- TR1195** Senator Lime Green
- TR1253** Rotavator Orange
- TR2393** Case Brown
- TR2396** New Cat Yellow
- TR2401** Case Tan
- TR2447** Kvernland Green
- TR3684** Land Rover Blue



59633
JD Green Spray
Can Aerosol
400ml

59623
JD Yellow Spray
Can Aerosol
400ml

NUFFIELD

- TR3490** Nuffield Orange/Red

51852



Quick Attach Euro Bracket Carrier Frame

53187

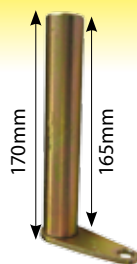

Pin for Quick Attach Euro Bracket Carrier

51102



Quick Attach Euro Bracket (Easy Fit)

52835



Quick Attach Euro Bracket Arms Only (Pair)

3946



Silage Grab Ram (20')

51228



Rear Linkage Quick Hitch (Tractor Side)

51228K

=
1x51228
1x51229

51229



Rear Linkage Quick Hitch Adaptor Kit no. 51228k

3564

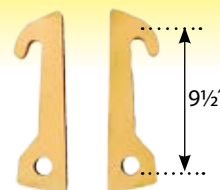

Tanco Loader Bracket - PAIR

221194
221192



Tine 26' Curved
Tine 32' Curved

221195



Tine 32' Cranked x 24mm

221193
221151



Tine 26' Straight
Tine 32" Straight



Stonefork Tine 32"
Stonefork Tine 48"
Stonefork Tine 980mm c/w Nut

32SF
241162
241161

3726

Nut 20mm to suit Loader Tine



3730

Nut 28mm for Stonefork Tine

4349

Stonefork Tine 41"

TB1

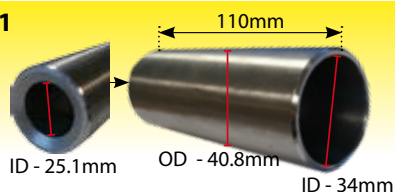

Bush for Kverneland Tines
110 mm Long 40.8 mm OD
34 + 25.1 mm ID
19.05mm

TB1HD

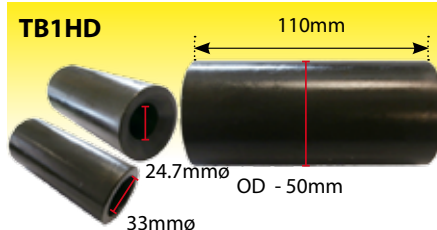

Bush for Kverneland Tines Heavy Duty
110 mm Long OD 50mm
ID 19.05mm

SB1

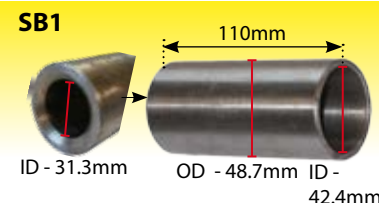

Bush Tapered Stonefork Tine
110 mm Long 48.7 mm
OD 42.4 + 31.3 mm ID
19.05mm

Hydraulic Top Links

**Cat 1 Ball
- Cat 1 Ball**



**Complete With Hose
& Anti-Creep Valve**

53458

Min Length	470mm	Cylinder ID	50mm
Max Length	680mm	Piston Rod Diameter	30mm
Ram Stroke	210mm		



**Complete With Hose
& Anti-Creep Valve**

53459

Min Length	540mm	Cylinder ID	50mm
Max Length	820mm	Piston Rod Diameter	30mm
Ram Stroke	280mm		

**Cat 2 Ball
- Cat 2 Ball**



**Complete With Hose
& Anti-Creep Valve**

53460

Min Length	430mm	Cylinder ID	50mm
Max Length	590mm	Piston Rod Diameter	30mm
Ram Stroke	160mm		



**Complete With Hose
& Anti-Creep Valve**

53461

Min Length	480mm	Cylinder ID	50mm
Max Length	690mm	Piston Rod Diameter	30mm
Ram Stroke	210mm		



**Complete With Hose
& Anti-Creep Valve**

53462

Min Length	570mm	Cylinder ID	63mm
Max Length	886mm	Piston Rod Diameter	35mm
Ram Stroke	296mm		



Complete With Hose

53463

Min Length	620mm	Cylinder ID	63mm
Max Length	931mm	Piston Rod Diameter	35mm
Ram Stroke	311mm		

Hydraulic Top Links

**Cat 2 Hook
- Cat 2 Ball**



**Complete With Hose,
Anti-Creep Valve
& Transport Handle**

53464

Min Length	585mm
Max Length	859mm
Ram Stroke	274mm
Cylinder ID	63mm
Piston Rod Diameter	35mm



**Complete With Hose,
Anti-Creep Valve
& Transport Handle**

53465

Min Length	595mm
Max Length	834mm
Ram Stroke	239mm
Cylinder ID	80mm
Piston Rod Diameter	40mm

**Cat 2 Hook
- Knuckle**



**Complete With Hose,
Anti-Creep Valve
& Transport Handle**

KNUCKLES NOT INCLUDED

53453

Min Length	580mm	640mm Including Knuckle
Max Length	825mm	885mm Including Knuckle
Ram Stroke	245mm	
Cylinder ID	80mm	
Piston Rod Diameter	40mm	

**Knuckle
Options**



53467 Cat 2
25mm
Pin & R Clip included



53468 28mm
28mm
Pin & R Clip included



53469 Cat 3
32mm
Pin & R Clip included



**Complete With Hose,
Anti-Creep Valve
& Transport Handle**

KNUCKLES NOT INCLUDED

53454

Min Length	620mm	680mm Including Knuckle
Max Length	905mm	965mm Including Knuckle
Ram Stroke	285mm	
Cylinder ID	80mm	
Piston Rod Diameter	40mm	

Hydraulic Top Links

Cat 3 Ball
- Knuckle



Complete With Hose,
Anti-Creep Valve
& Transport Handle
NUCKLES NOT INCLUDED

53452

Min Length	580mm	640mm Including Knuckle
Max Length	825mm	885mm Including Knuckle
Ram Stroke	245mm	
Cylinder ID	90mm	
Piston Rod Diameter	45mm	

Cat 3 Hook
- Knuckle



Complete With Hose,
Anti-Creep Valve
& Transport Handle
NUCKLES NOT INCLUDED

53455

Min Length	505mm	565mm Including Knuckle
Max Length	646mm	706mm Including Knuckle
Ram Stroke	141mm	
Cylinder ID	90mm	
Piston Rod Diameter	40mm	

Knuckle
Options



53467 **Cat 2**
25mm
Pin & R Clip included



53468 **28mm**
28mm
Pin & R Clip included



53469 **Cat 3**
32mm
Pin & R Clip included



Complete With Hose,
Anti-Creep Valve
& Transport Handle
NUCKLES NOT INCLUDED

53456

Min Length	590mm	650mm Including Knuckle
Max Length	816mm	876mm Including Knuckle
Ram Stroke	226mm	
Cylinder ID	90mm	
Piston Rod Diameter	45mm	



Complete With Hose,
Anti-Creep Valve
& Transport Handle
NUCKLES NOT INCLUDED

53457

Min Length	620mm	680mm Including Knuckle
Max Length	835mm	895mm Including Knuckle
Ram Stroke	215mm	
Cylinder ID	105mm	
Piston Rod Diameter	45mm	

Knuckle Options

Cat 2



53467
25mm CAT2
Pin & R Clip

Cat 28mm



53468
28mm
Pin & R Clip
Suits Ford 40s TSs

Cat 3



53469
32mm CAT3
Pin & R Clip



53466
Pin & R Clip

Handles

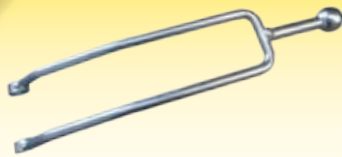

43142
Handle - New Holland

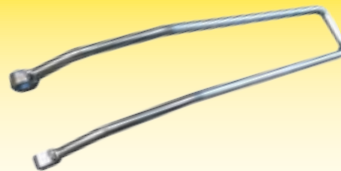

53471
Handle -
Long 10mm / 350mm



59028
Handle - John Deere



53470
Handle
Short 10mm / 275mm



53472
Handle Clip

Balls



4044
Cat 2



21018
Cat 2/3



21019
Cat 3/3

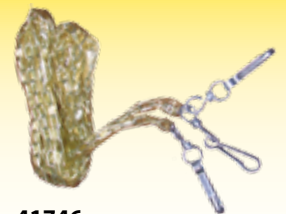

41746
Chain For Quick
Release CBM Type

Standard Top Links

1690

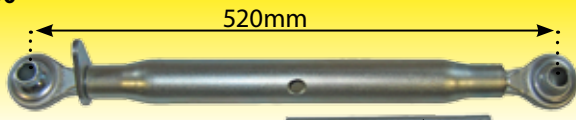

Top Link 16" Cat 1
 Tube 16" (Adj. Min 20 3/4" Max 28 7/16")
 ** Ratchet Handle is 51770 **

1689

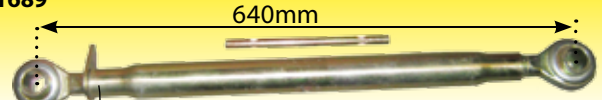

Top Link 20" Cat 2
 Tube 20" (Adj. Min 25 3/32" Max 36 7/32")
 ** Ratchet Handle is 51770 **

51770



Handle for Ratch on Top Link
 ** fits 62108 1689 1690 1547 51720 **

21008

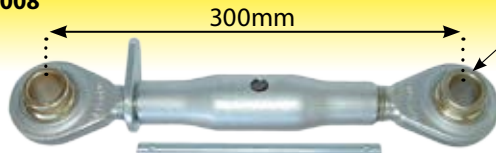

Top Link Assembly Cat 2 - Standard Duty Tube
 7" (Adj. Min 12 3/32" Max 15 1/32")

21022

Screw On End For
 21008 RH Thread

21011

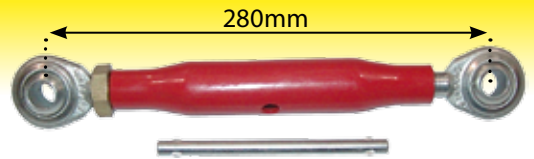

Top Link Assembly - Standard Duty
 Tube 7 1/2" (Adj. Min 11 1/32" Max 15 15/32")

21021

Top Link Assembly Cat 1 Cat 2 - Standard Duty

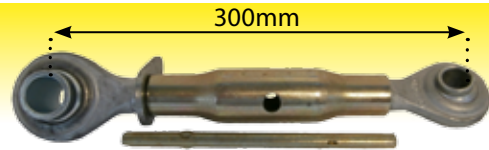

21010

Top Link Assembly Cat 2
 Tube 11 1/4" (Adj. Min 16 1/2" Max 23 1/32")

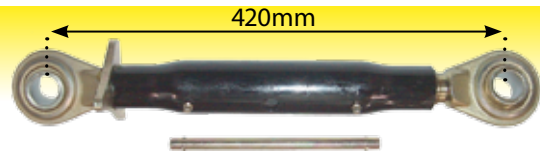

2474

Top Link David Brown Cat 2 Cat 1 +
 Conversion Tube 14 1/2" Adj Min 20"
 Max 30"



3785

Top Link 16" Heavy Duty Cat 2

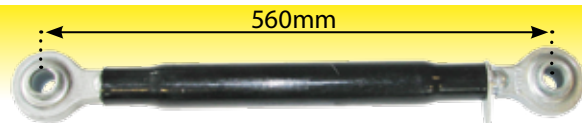

62108

Top Link 16" Cat 1 & 2
 ** Ratchet Handle is 51770 **

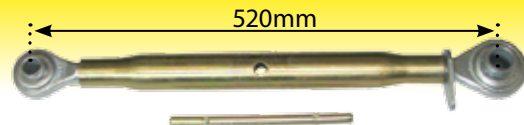

1547

Top Link 20" Cat 1 & 2
 Tube 20" (Adj. Min 24 27/32" Max 32 25/32")
 ** Ratchet Handle is 51770 **

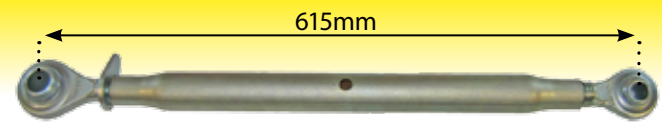

3792

Top Link Cat 2 Heavy Duty
 Tube 19" Adj Min 24 7/16" Max 35 5/16"



3676

Top Link Cat 3 H/D 19" Jumbo
 Tube 19" Adj Min 25 5/16" Max 35 7/16"



Cat 3 to Cat 2 Conversion Bush=53475

Massey Ferguson

1164 Top Link 165 188 21.5" Cat 2 + 2
(Adj. Min 26 1/2" Max 33")

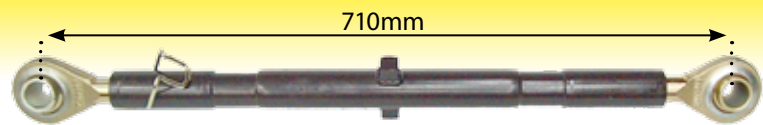

1165 Top Link 188 590 595 21" Cat 2
(Adj. Min 25" Max 34 1/2")

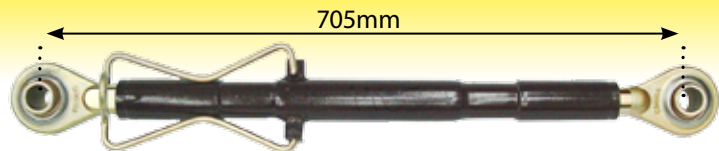

2525 Top Link Quick Release 3000 3100 6100's
Adjustment - Min 25" Max 29"



61611 Top Link 135 148 Cat 1/1
(Min 24" 610mm Max 30 1/4" 770mm)
** Use with 35" Lift Arm 1869289 **

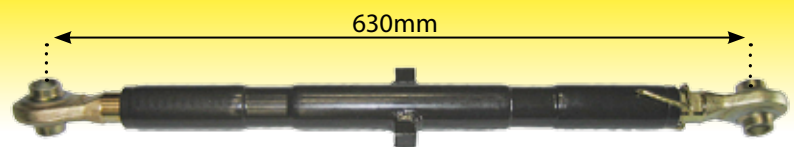

61612 Top Link 135 148 Cat 1/2
(Min 24" 610mm Max 30 1/4" 770mm)



61609 Top Link Assembly FE 35 135 Cat 1/1
(Min 23" / 590mm Max 29 1/2" 750mm)



61610 Top Link Assembly FE 35 135 Cat 1/2
(Min 23" / 590mm Max 29 1/2" 750mm)
** Use with 32" Lift Arm 182632 ""

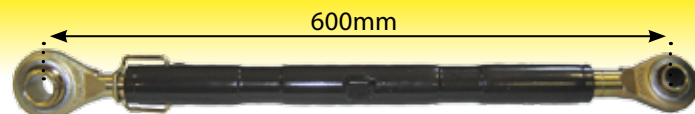

41738 Top Link CBM Cat 2 (15" Tube) Min 23" Max
31" Landini Legend/Mc Cormack MC & MTX's

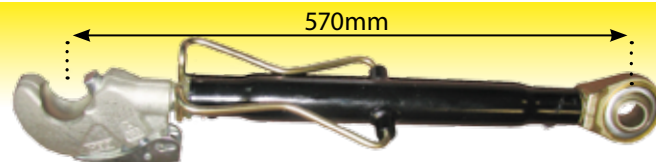

62093 Top Link For TE 20 Original Type

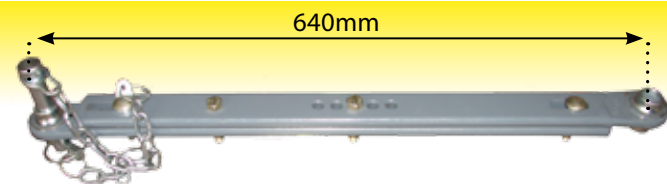

63459
Top Link 35 135 148 Cat 1/2 Min 27" 685mm
Max 33" 838mm OE Ref: 1870075M91



OE Style Top Links

John Deere

59768 Top Link John Deere 6000 CAT II/III 38mm
24" (61cm) long (Centre to Centre)

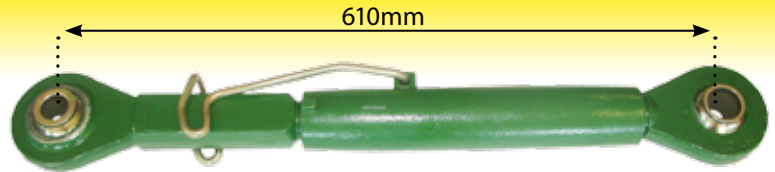

59287 Top Link John Deere 6000 CAT II/II
605mm Centre to Centre
59771 is Budget Version

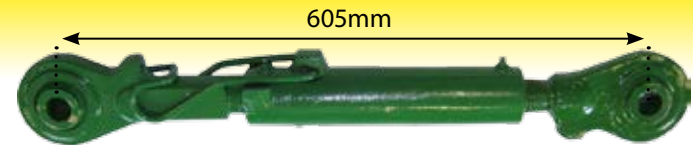

59771 Top Link John Deere 6000 CAT II/II 38mm
23 1/2" (60cm) long (Centre to Centre)



2458 Top Link John Deere Cat 1 & 2 Heavy Duty
Adj Min 550mm Max 760mm

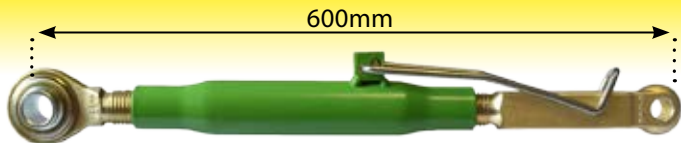

3252 Top Link Assembly John Deere 13" Cat 1 & 2
Adj Min 21 5/8" Max 30"

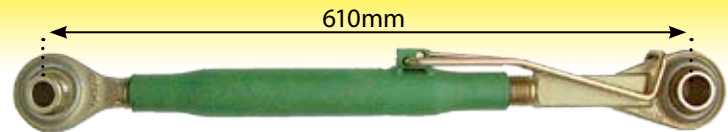

59772
Top Link John Deere 6000 CAT III/III 38mm

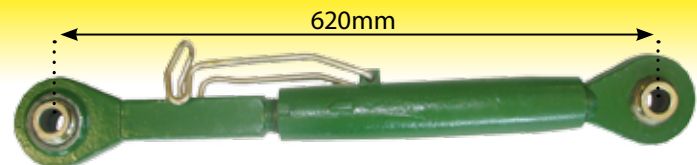

Ford

3027 Top Link Ford 5600 7600 17" Cat 2
Adj Min 24 1/2" Max 31 1/4" - 622 - 794mm

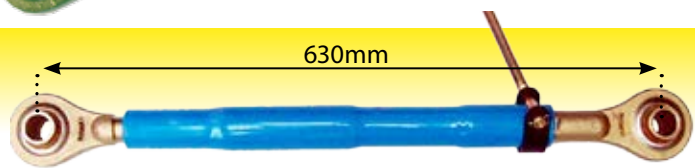

3028 Top Link Ford 4000 4600 16.75" Cat 1 + 2
Adj Min 24 1/2" Max 31 1/4"

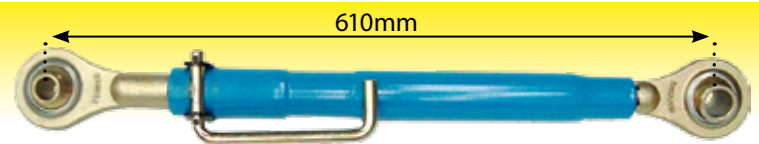

41309 Top Link Ford 40 - CAT 2 Ball 28mm Eye
Fiat M100 to M160 - Knuckle 53469



42066 Top Link Assembly TM TS Cat 3 Hook

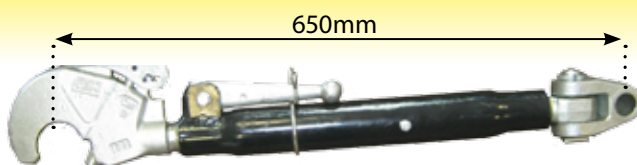

Kubota

51207
Top Link Kubota

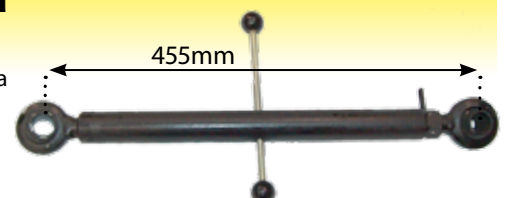

Heavy Duty Top Links

4115 Top Link John Deere/Fendt CAT 2 SuperLink
Tube 19" (Adj. Min 24 3/8" Max 34 7/8")



3251 Top Link CAT 3 Superlink
Tube 19" Adj Min 25 13/16" Max 35 3/16"

Cat 3 to Cat 2 Conversion Bush=53475

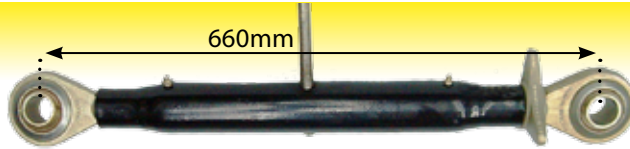

2199 Top Link John Deere Cat 2 SuperLink
Tube 15" (Adj. Min 20 9/32" Max 30 3/4")



3234 Top Link CAT 3 Superlink
Tube 15" Adj Min 21 27/32" Max 31 3/16"

Cat 3 to Cat 2 Conversion Bush=53475

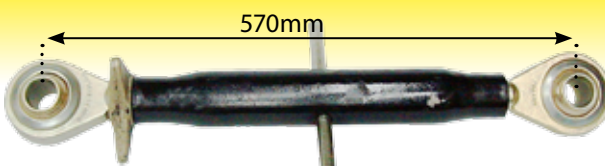

Knuckle Ends

3207 Quick Hitch Hook Cat 3/3 & Ball End Top Link
Tube 19" (Adj. Min 24 1/2" Max 35 5/8")

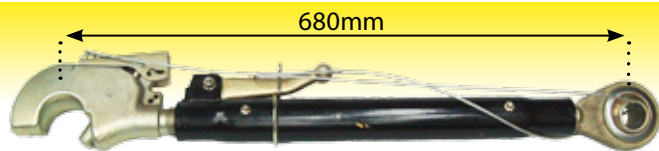

21003 Quick Hitch Hook CAT 2/3 & Ball End Top Link
Tube 15" (Adj. Min 20 11/16" Max 32 1/16")

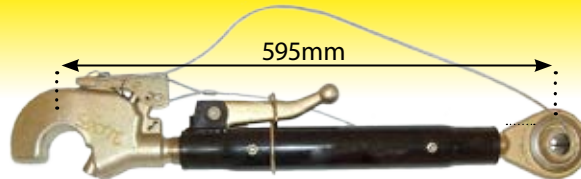

21004 Top Link Cat 3 Ball End & Knuckle End
Tube 15" Adj Min 21 11/16" Max 32 1/2" 25mm B
* Top Link End is 21016 * 25mm Bore 50mm

Cat 3 to Cat 2 Conversion Bush=53475



Height
50.8mm
Hole
25.4mm

21005 Top Link Cat 3 Ball End & Knuckle End
Tube 15" Adj Min 21 11/16" Max 32 1/2" 28mm B

Cat 3 to Cat 2 Conversion Bush=53475



Hole
28mm
Height
65mm

21006 Top Link Cat 2 Ball End & Knuckle End
Tube 15" Adj Min 21 11/16" Max 32 1/2" 25mm B

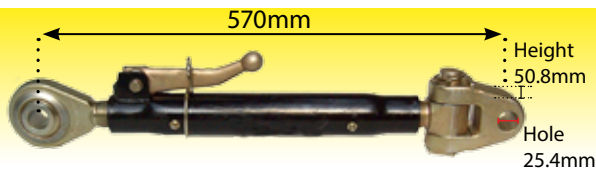

Height
50.8mm
Hole
25.4mm

21007 Quick Hitch Hook CAT 2 & Knuckle End Top Link
Tube 15" (Adj. Min 20 11/16" Max 32 1/16")
25mm bore



Hole
25.4mm
Height
50.8mm

21014 Top Link John D Cat 2 3 Ball End & Knuckle End
Tube 15" Adj Min 21 11/16" Max 32 1/2" 32mm B



Hole
31.8mm
Height
50.8mm

Top Link Components

Accessories

59923

Top Link Knuckle
John Deere

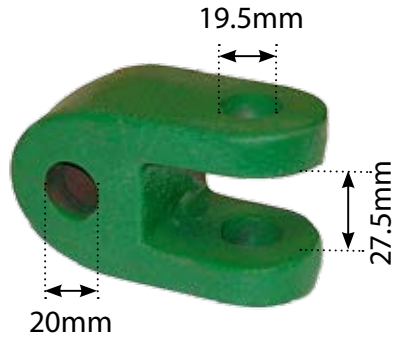

61293

Top Link Securing
Hook



53059

Top Link Holder



Top Link Pins

195589 Top Link Pin Cat 1 Working Length: 102mm

195590 Top Link Pin Cat 1 Working Length: 110mm

1461 Top Link Pin Cat 1 4.75" Working Length: 127mm

2363 Top Link Pin 188 CAT 2 4 5/16" Working 110mm

53028 Lower Link Pin Cat 1 22 x 78mm

53029 Top Link Pin Cat 1

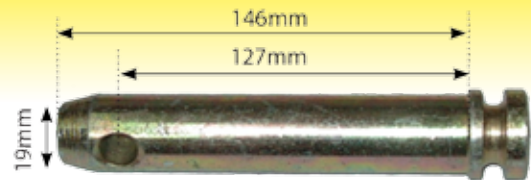

Lower Link Implement Pin

53048 Lower Link Implement Pin Cat 2

53031 Lower Link Implement Pin Cat 2 1 1/8" UNC

53032 Lower Link Implement Pin Cat 1/2 1" UNC

53030 Lower Link Implement Pin Cat 1 / 2 1" UNF

62795 Lower Link Pin Cat 1 Mounting Pin



Lower Links

4418 **Cat 2**



Link Ball Lower c/o Guide Cone Cat 2 ***Pin To Suit 4419***

4727 **Cat 3/3**



Link Ball Cat 3/3 & Guide Cone ***Pin To Suit 4419***

4729 **Cat 2/3**



Link Ball Cat 2/3 & Guide Cone ***Pin To Suit 4419***

4419



Linch Pin for 4418
12mm Diameter Pin

Lower Link Balls

53041 **Cat 1/2**



Lower Link Ball Dual
Cat 1/2

2539 **Cat 3/2**



Lower Link Ball
Cat 3/2 ID 29 OD 63.5

2540 **Cat 3/3**



Lower Link Ball Cat 3/3
ID 37.5mm
OD 63.5mm

62228 **Cat 2/2**



Ball Cat 2/2 For Lower
Quick
Release End

1869219



Lift Arm Ball Clip

886428



Lower Link Ball Cat 1 Interchangeable
Fits 100 200 300 4200 4300 600 Series

Cat 1

886429



Lower Link Ball Cat 2 Interchangeable
Fits 100 200 300 4200 4300 500 600
Series

Cat 2

Lower Link Conversion Bushes

43155 **Cat 2 to Cat 3**



Bush Lower Link Conversion
Cat 2 to Cat 3

53496 **Cat 2 to Cat 3**



Bush Lower Link Conversion Cat 2 to Cat 3
ID 1 1/8" OD 1 7/16" Length 2 1/2" 63.5mm

2424 **Cat 1 to Cat 2**



Lower Link Conversion Bush 1 1/8' to 7/8'

Top Links

21018

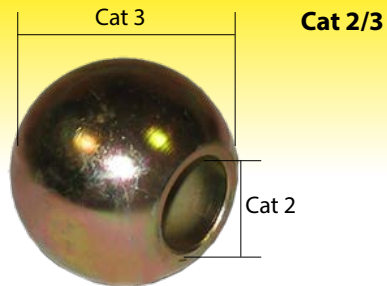

- Top Link Ball Cat 2/3
- I/D Ø: 1".
 - O/D Ø: 2 23/64".
 - Width: 2".

21019



- Top Link Ball Cat 3/3
- I/D Ø: 1 9/32".
 - O/D Ø: 2 23/64".
 - Width: 2".

4044

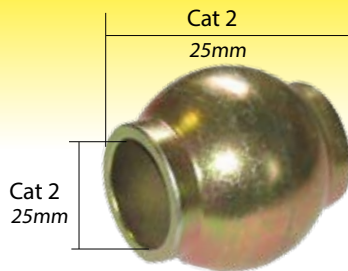

Top Link Ball CAT 2

21001



Ball Cat 3 Toplink

Top Link Conversion Bushes

53475





Bush Top Link Conversion Cat 2 Cat 3

42144

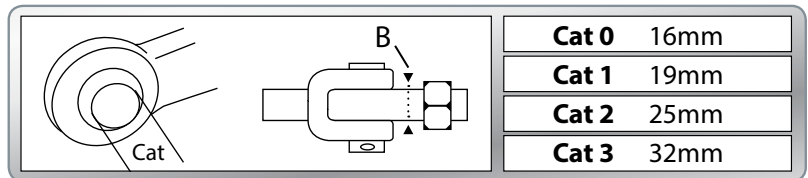

Top Link Conversion Bush Ford 10
100 Cat 1/2
1000 30 40 Industrial TW Series





CAT 1		Part	Applications	Cat	Min	Max	B
	410mm	61495	Stabiliser 290 Telescopic 61511 & 61510 - Stabiliser Brackets	1	410	570	20
	450mm	61496	Stabiliser 265 Telescopic	1	410	570	20
	520mm	62138	Stabiliser 690 699 290 390 Heavy Duty End - 51976	1	520	690	20
	590mm	61214	Stabiliser Assembly 4200 4300	1	590	860	25

CAT 1		Part	Applications	Cat	Min	Max	B
	410mm	62955	Stabiliser 5400 6200 6400 8200	2	410	620	25
	450mm	62139	Stabiliser 3 31 36 61 62 81 8200's Heavy Duty End - 51974	2	450	640	25
	450mm	62309	Stabiliser 6400 7400 480 - 450mm Automatic	2	450	570 Float is 50	25
	500mm	62813	Stabiliser 5425 5435 5445 5455 5460 5465	2	500	640	27



Vintage Stabilisers

	2805	Stabiliser Short Adjustable - Min 376mm Max 471mm
	894208	Stabiliser Bar 65 165 Adjustable Min 723mm Max 914mm 23mm Hole

897678



Eye Bolt Assembly 20D 35 - 4 Cylinder



897677

Eye Bolt Assembly 35 35X 133 135 140 45mm

Chain Stabilisers & Check Chains

	2041	Check Chain 35 135 - PAIR
	62128	Chain Stabiliser 135 - 2 Links
	2225	Chain Stabiliser 135 Heavy Duty
	1863260	Chain Stabiliser 135 240 Chain OE Type
	1861968	Check Chain 148 240
	893410	Check Chain 265 285 - 5 Link 62 x 12.5mm
	2522963	Chain Stabiliser 188 165 390 590
	2044	Chain Stabiliser - All Models Min 819mm Max 927mm

61601

Check Chain Mounting Bracket (Pair)



1824

D Shackle Clevis Assembly



1865159

Stabiliser Spacer 165 300 Also 200 500 600 Series



Brackets

1395 Stabiliser Bracket 35 135 Left Hand

62621 Stabiliser Bracket 165 168 175 178 185 188 Left Hand

61511 Stabiliser Bracket Square Axle Left Hand

2818

Stabiliser Bracket 135/240 RH & LH

1394 Bracket Right Hand

62620 Bracket Right Hand

61510 Bracket Right Hand



562620

Stabiliser Bar 3 Hole Spring Steel Flat



63282

Stabiliser Bars & Brackets Kit 35 135







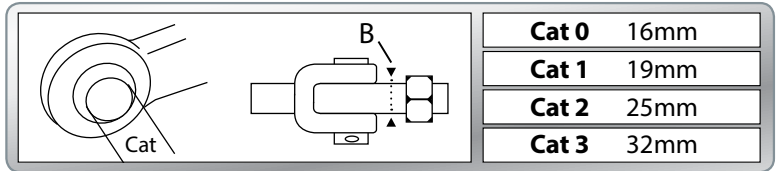

1691

Stabiliser Bar 2 Hole Flat





CAT 1		Part	Applications	Cat	Min	Max	B
	410mm 18mm	59894	Stabiliser John Deere 6010-6920	1	410	540	18
	450mm	59920	Stabiliser John Deere 6000's	1	450	510	18
	480mm	59654	Stabiliser John Deere 6000's H Duty Short End - 51974 59650 - Stabiliser Bracket	1	480	700	25
	530mm	59653	Stabiliser John Deere 6000's H Duty Long End is 51975	1	530	760	25

CAT 2		Part	Applications	Cat	Min	Max	B	Float
	448mm	59089	Stabiliser John Deere Automatic 6010 6110 6210 6310 6410 6510 6610 6810 6910 7600 7700 7800 7430PR	2	448	467	24	+ - 36
	461mm	59090	Stabiliser Automatic New Holland TM175 TM190 T7030 T7040 T7050 T7060 John Deere 8000 8010 8110 8200 8210 8300 8310	2	461	482	28	+ - 36

Chain Stabiliser



51099

Chain Stabiliser Assembly
John Deere 2040 3640

51974

Stabiliser End Threaded
John Deere 6000 Serie
Heavy Duty Short

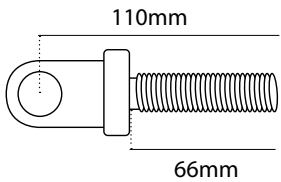

51975

Stabiliser End John Deere
6000 H Duty Long
Length: 122mm, Dia: 24mm

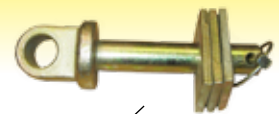
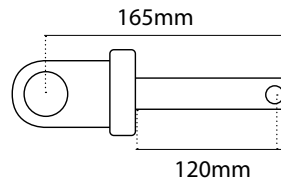

59654

Stabiliser John Deere
6000's H Duty Short



59653

Stabiliser John Deere
6000's H Duty Long



Brackets

59650

Stabiliser Bracket John Deere
6800 6900 6810 6910 6820
6920 6920s 6830 6930 Not For
6600 or any 4 Cylinder Models



6 Cylinder

58960

Bracket Stabiliser 6100 6200 6300
6300 6400 6506 6600 6010 6110
6210 6310 6410 6510 6610 6810
6910 6910S 6020 6120 6220 6320
OE Ref: L155798









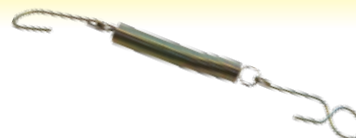

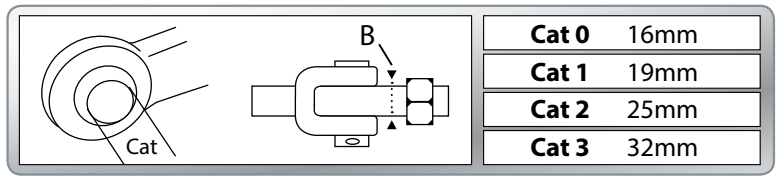
4 Cylinder

53102

Spring Lower Link Restrainer
Min 17.5" 400mm Max 30" 765mm





	Part	Applications	Cat	Min	Max	Float	B
 <p>380mm</p> 	42258	T6030 T6050 TS115A TS130A T6040 TS110A T6010 T6070 TS100A T6060 Stabiliser Pin -42259 Bracket - 43505	1	380	560		20
 <p>430mm</p>	41763	TM & 60s Heavy Duty OE Ref: 5170360	1	430	630		25
 <p>430mm</p>	41763R	TM & 60s Normal Duty End is 51978		430	630		25
 <p>430mm</p> 	43037	TM115 TM125 TM135 TM150 TM165 Automatic	1	430	490	40	26
 <p>461mm</p>	59090	Automatic TM175 TM190T7030 T7040 T7050 T7060	2	461	482		36
 <p>460mm</p>	4964	Ford 4000	1	460	650	40	18

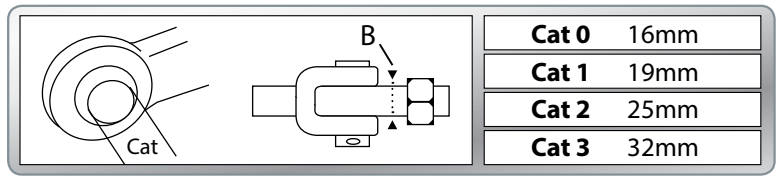



	Part	Applications	Cat	Min	Max	Float	B
 <p>480mm</p>	12000	Ford 40 TS 8210 Replacement (A 7/8' B 3/4') (NORMAL DUTY)	1	470	620		20
 <p>500mm</p>	42257	Ford TS100 TS110 TS115 TS80 TS90 Also fits TV140	1	500	740		20
 <p>500mm</p>	41802	5000 - 8210 Heavy Duty End - 51973	1	500	720		18
 <p>520mm</p>	409710	Ford 40 Series Heavy Duty End is 51973	1	520	730		20
 <p>540mm</p>	4963	5000	1	540	770	40	18
 <p>430mm</p>	43244	Stabiliser Ford 2000 3000 3600	1	430	600		
 <p>380mm</p>	43537	T4000s TNs	1				

FORD & NEW HOLLAND

Chain Stabilisers & Components

Chain Stabilisers

	1951	Stabiliser Power Major ** D Shackle is 53202 **
	3026R	Stabiliser Ford 4000 4600 4610
	3025R	Stabiliser Ford 5000 5600 6600 7000 7600
	41821	Chain Stabiliser Ford 4000 4600 4610 4630 And 5000 5030 5600 6600 7000 7600



53202
D Shackle for 1951



53203
U Bolt Suits 3026R
3025R 1635

1168
Chain Stabiliser Tube Ford + Weight



43345
Anchor Bracket Check Chain Ford 2000 4000 600
800 900 601 701 801 901 Dexta Super Dexta 2N
8N 9N Jubilee NAA Left Hand [OE Ref: 957E596](#)



43344
Anchor Bracket Check Chain Ford 2000 4000 6008N
9N Jubilee NAA Right Hand [OE Ref: 957E597](#)

Stabilisers Hangers

41359
Stabiliser Hanger
Ford 2910/3910 Left
Hand



41360
Stabiliser Hanger Ford
2910/3910 Right Hand

41364
Stabiliser Hanger Ford
6610 7610 Left Hand

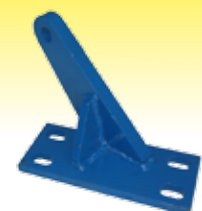

41361
Stabiliser Hanger Ford
6610 7610 Right Hand

FORD & NEW HOLLAND

Stabiliser Components

52193

Clevis for 41802 Ford 5000 -
8210 Stabiliser Heavy Duty

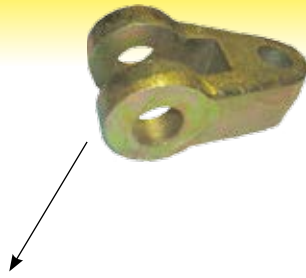

51973

Stabiliser End Threaded Ford
40 Series H Duty

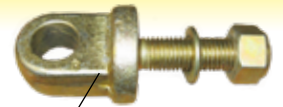
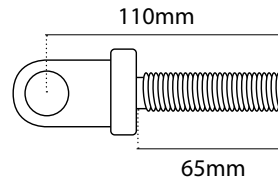

41802

Stabiliser Ford 5000 -
8210 Heavy Duty



409710

Stabiliser Ford 40
Series Heavy Duty



52194

Pin for 41763 TM & 60s
Stabiliser



51978

Stabiliser End TM & 60 Series H
Duty Length: Dia: 25mm

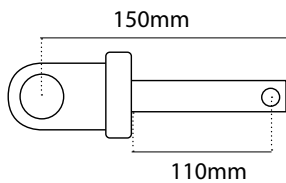

42259

Pin Stabiliser Ford T6030 T6050 TS115A
TS130A T6040 TS110A T6010 T6070
TS100A T6060



43505

Stabiliser Bracket Ford T60s TSAs



41763

Stabiliser TM & 60s
Heavy Duty



42258

Stabiliser Ford T6030 T6050
TS115A TS130A T6040 TS110A
T6010 T6070 TS100A T6060



U Bolts

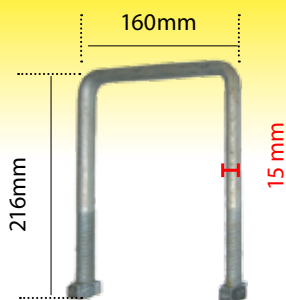

41366

6610/7610 Stabiliser
Bracket U Bolt

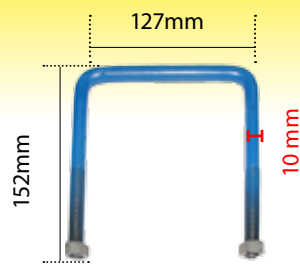

41581

U Type Bolt Ford
3000 Mudguard

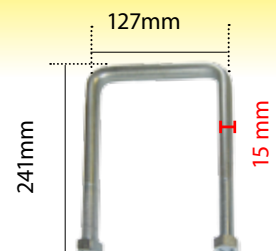



41512

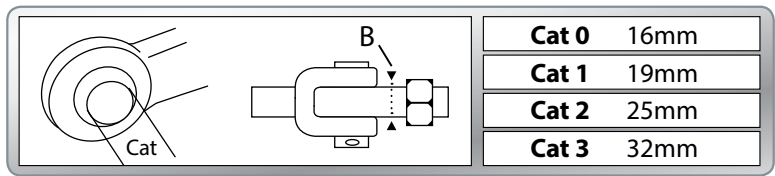

U Bolt For Stabiliser
Fixing Bar Ford 2910/
3910/4110/4620

Stabilisers



Cat 0	16mm
Cat 1	19mm
Cat 2	25mm
Cat 3	32mm

CASE	Part	Applications	Cat	Min	Max	B
 <p>320mm</p>	59652	McCormick Case CX H Duty End = 51972	1	320	450	22
 <p>520mm</p>	59651	McCormick Case MX H Duty End = 51972	1	520	720	22
 <p>390mm</p>	52460	Case 640 644 740 743 744 745 745S 840 844 844S 845 856 940 946 955 956 1046 1056	1	390	640	
	1635	IHC All Models 385 454 474 475 484 485 485 XL 574 584 585 585 XL 674 684 685 685 XL 784				

DAVID BROWN	Part	Applications	Cat	Min	Max	B
	2171	Stabiliser Assembly David Brown 4 Cylinder 990 995 996 1210 1212 1290 1294 1390 1394 1410 1412 1490 1494	1	635	750	20
 <p>470mm</p>	2204	Stabiliser David Brown 1690 1594 1694	2	470	780	20

RENAULT	Part	Applications	Cat	Min	Max	B
 <p>585mm</p>	780061	Stabiliser Renault Ceres MS - MX	2	585	835	24

Stabilisers

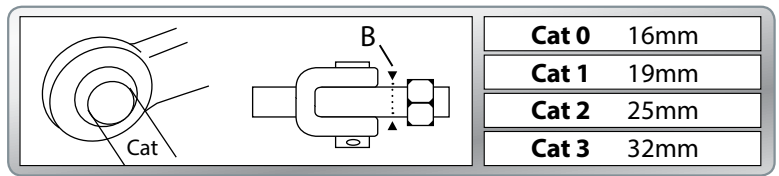



Cat 0	16mm
Cat 1	19mm
Cat 2	25mm
Cat 3	32mm

FIAT	Part	Applications	Cat	Min	Max	B
 420mm	4063	Stabiliser Fiat 100-90 420mm Long	1	420	530	25
 440mm	59511	Stabiliser Fiat 90 Series Heavy Duty End = 51977	1	440	640	25
	7821	Stabiliser Fiat 115-90 130-90 140-90 160-90 180-90		480	630	28

ZETOR	Part	Applications	Cat	Min	Max	B
 600mm	59649	Stabiliser Zetor Forterra Heavy Duty	1	600	840	20

LANDINI	Part	Applications	Cat	Min	Max	B
 530mm	59519	Stabiliser Landini Ghibli 90 530mm long End = 51974	1	530	750	25

SAME	Part	Applications	Cat	Min	Max	B
 510mm	41737	Stabiliser Same Explorer 95 & 110 Silver	1	510	570	20

VALTRA	Part	Applications	Cat	Min	Max	B
 490mm	52867	Stabiliser Valtra Valmet T Series	2	490	720 Float is 45	20

Stabilisers Normal Duty

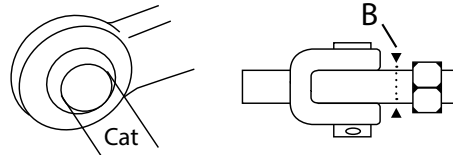

Cat 0 16mm

Cat 1 19mm

Cat 2 25mm

Cat 3 32mm

MISCELLANEOUS Cat 1		Part No	End to Suit	Cat	Min	Max	Float	B
	440mm	12010	End = 51974 	1	440	600	50	25
	470mm	12000	End = 51973 	1	470	620		20
	510mm	12030	End = 51974 	1	510	670	50	25
MISCELLANEOUS Cat 2		Part No	Description	Cat	Min	Max	Float	B
	440mm	12020	End = 51974 	2	440	600	50	25
	510mm	12040	End = 51974 	2	510	670	50	25

Stabilisers Heavy Duty

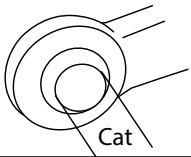
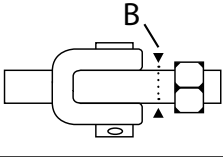
		Cat 0 16mm
		Cat 1 19mm
		Cat 2 25mm
		Cat 3 32mm

MISCELLANEOUS Cat 1		Part No	Description	Cat	Min	Max	Float	B
	12011	Stabiliser Rigid Min 440 Max 600mm	1	440	600	50	25	
	12031	Stabiliser Rigid Min 510 Max 670	1	510	670	50	25	
MISCELLANEOUS Cat 2		Part No	Description	Cat	Min	Max	Float	B
	12021	Stabiliser Rigid 3000 Min 440 Max 600	2	440	600	50	25	
	12041	Stabiliser Rigid Min 510 Max 670mm	2	510	670	50	25	

Stabiliser Pins

- 51739** Shaft Locking Pin 8mm x 57mm
- 51740** Shaft Locking Pin 6mm x 50mm
- 53494** Shaft Locking Pin 11mm x 89mm
- 51741** Shaft Locking Pin 11mm x 89mm
- 51742** Shaft Locking Pin 9.5mm x 57mm
- 7387** Stabiliser Pin Fiat 100-90 Ford 40 16mm Thick
- 53060** Linch Pin Stabiliser 59mm x 10mm
- 53064** Pin Shaft Locking 9.5 x 40mm

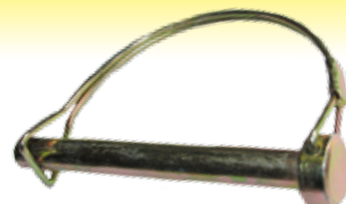

Linkage Components

4035



Lift Arm Spring Ford 5000 7200 Lower
Adjustable Spring Spacer (500 - 720mm Adj)

7819



Spring Lower Link Restrainer Ford F140 7030 7070 TM115
TM190 Fiat 55-46 65-66 60-90 80-90 90-90 100-90 110-90
180-90

Clevis End



Part No	Size A mm	Size B mm	Photo
12330	6	12	
12331	8	16	
12332	10	20	
12333	12	24	
12334	14	27	

Part No	Size A mm	Size B mm	Photo
12335	16	32	
12385	18	36	
12386	20	40	

Clevis End Pins

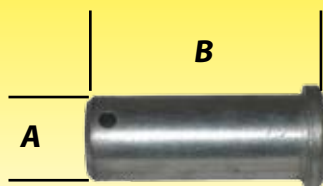

Part No	Size A mm	Size B mm	Photo
12336	6	16	
12337	8	20	
12338	10	25	
12339	12	30	
12340	14	36	
12341	16	42	
12389	20	49	

Clevis End Safety Pins

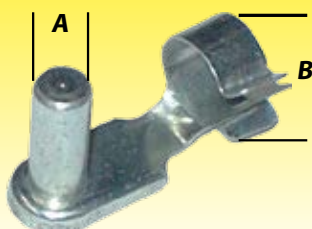

Part No	Size A mm	Size B mm
12345	12	29
12346	14	32
12347	16	35
12390	20	44

Linkage Components

Combine Fingers

51903

Combine Finger Suitable for Schumacherr



51904

Combine Finger John Deere
OE Ref: H25602



51906

Combine Finger New Holland
OE Ref: 379720



51905

Combine Finger Claas



Clips

52896

Suits 8mm Pin



Spring Clip

6988

Suits 7mm Pin



Speed Clip 200 300 600 4200 4300

1861511

Suits 6mm Pin



Control Valve Lever Ret Clip

7207

Suits 4mm Pin



Throttle Cable Clip Fiat

Ball Ends



- 4039** Ball End 5 x 1
- 4040** Ball End 6 x 1
- 4041** Ball End 8 x 1.25
- 4042** Ball End 10 x 1.5

Grip Pins



- 2690** Grip Pin 3mm
- 4219** Grip Pin 5mm

Split Pins



- 1354** Split Pin 1/16" x 2"
- 1468** Split Pin 5/16" x 1" Zinc Plated
- A1505** Split Pin 6.3mm x 40mm
- A1509** Split Pin 8mm x 63mm

53604

Split Pin Large Kit 144pcs OE Ref:



53595

Split Pin Kit 1000pcs



Linkage CBM Type



41738

Top Link CBM Cat 2 (15' Tube) Min 23' Max 31'
Landini Legend/Mc Cormack MC & MTX's



Waltersheid Quick Attach Hook Kits

61226



Quick Attach Hook Kit 6200 8200 Cat 3
Also fits John Deere

59039



Repair Kit Lower Link John Deere Ford Fiat
Case Cat 3

63236



Lever Quick Attach
CAT3 With Pin

63237



Lever Spring Cat 2 Cat 3 Quick Attach

61227



Quick Attach Hook Kit 390 4200 6200 Cat 2
Also fits John Deere

59035



Repair Kit Lower Link John Deere Fiat Cat 2

59058



Lever Quick Attach CAT2

63237



Lever Spring Cat 2 Cat 3 Quick Attach



Brakes, Linkage & Hydraulics

Date:.....

No. of Pages:.....

Name of the Rep.....

A/C Number:.....

From:.....

e-mail.....

Phone No.:.....

Fax No.:.....

Please quote for the following parts - Quotation Number :

I wish to confirm the following order on Quotation Number:

Please supply the following parts:

Please photocopy this page

Please do not remove this page

	Qty	Part No.	Description	Unit Price
1.				
2.				
3.				
4.				
5.				
6.				
7.				
8.				
9.				
10.				
11.				
12.				
13.				
14.				
15.				
16.				
17.				
18.				
19.				
20.				
21.				
22.				
23.				
24.				

Comments:

Customer Signature: _____ **Rep's Signature:** _____

Tel No: + 353 44 934 1638

e-mail: info@qtponline.com, www.qtponline.com

Page of

Linkage CBM Type

CAT 2

41734

Quick Release End CBM type
Weld On Cat 2

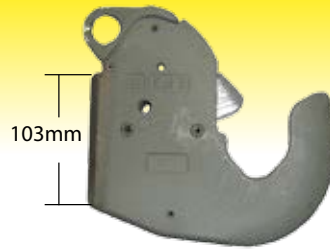

41735

Quick Attach Hook
Kit CBM Cat 2



CAT 2S

41773

Quick Release End CBM CAT 2S
Weld On LH+RH

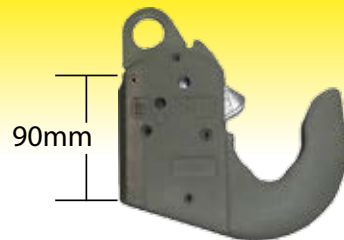

53839

Quick Attach Hook Kit Cat 2S
Cat 2s



CAT 3

53381

Quick Release End CBM Weld
On Cat 3

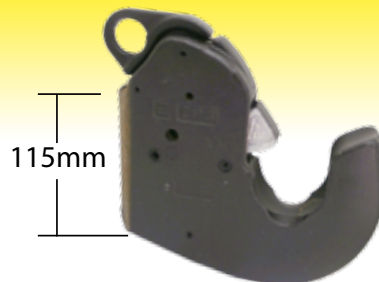

41736

Quick Attach Hook Kit CBM
Cat 3



CAT 4

64444

Weld On Quick Attach Hook
OE Ref: 3905500M91



53836

Cat 4 Quick Attach
Hook Kit CBM



41739

Eye bolt Ring Quick Re-
lease Chain 3000 5400



41746

Chain For Quick
Release CBM Type



4418



Link Ball Lower c/o Guide Cone Cat 2 ***Pin To Suit 4419***

4419



Linch Pin for 4418 12mm Diameter Pin

4727



LINK BALL Cat 3/3 & Guide Cone ***Pin To Suit 4419***

Cat 2 to Cat 3 Conversion Bush=53496

4729



Link Ball Cat 2/3 & Guide Cone ***Pin To Suit 4419***

53041



Lower Link Ball Dual Cat 1/2

2539



Lower Link Ball Cat 3/2 ID 29 OD 63.5

2540



Lower Link Ball Cat 3/3 ID 37.5mm OD 63.5mm

Cat 2 to Cat 3 Conversion Bush=53496

Lower Link Cat 2 to Cat 3 Conversion Bush=43155

62228



Ball Cat 2/2 For Lower Quick Release End

21001



Ball Cat 3 Toplink Cat 3 to Cat 2 Conversion Bush=53475

21019



Top Link Ball Cat 3/3 Cat 3 to Cat 2 Conversion Bush=53475

21018



Top Link Ball Cat 2/3

886428



Lower Link Ball Cat 1 Interchangeable Fits 100 200 300 4200 4300 600 Series

886429



Lower Link Ball Cat 2 Interchangeable Fits 100 200 300 4200 4300 500 600 Series

Linkage CBM Type

59289

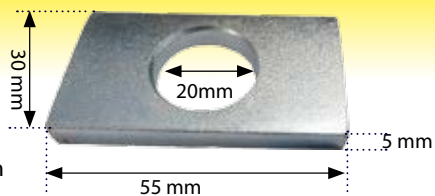

Pin Plate Square John Deere 6000
20mm Hole

59288

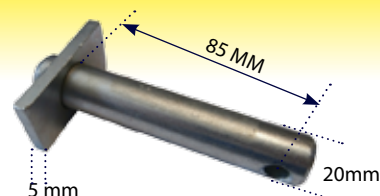

Lower Levelling Box Pin John Deere 6000

41747

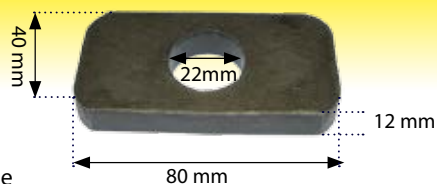

Bottom Fork Plate CBM Type 22mm

41748

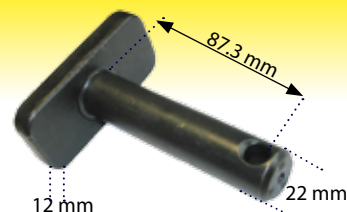

Bottom Fork Lift Link Pin CBM Type 22mm

 **CBM** SpA
COSTRUZIONI MECCANICHE

 **CBM** SpA
COSTRUZIONI MECCANICHE

59822

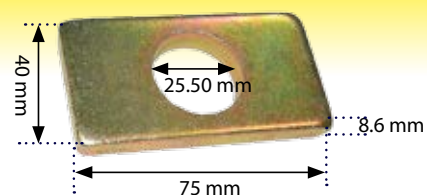

Fork Plate John Deere 76 77 7810 Bottom

41743

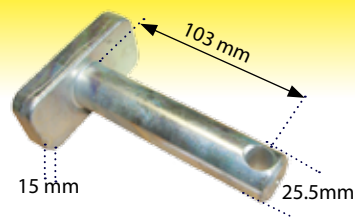

Bottom Fork Lift Link Pin CBM Type 25.50mm

 **CBM** SpA
COSTRUZIONI MECCANICHE

41740

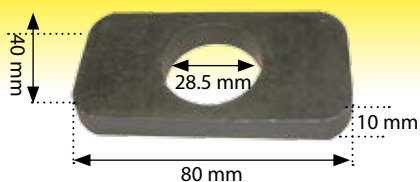

Bottom Fork Plate CBM Type 28.5mm hole

41741

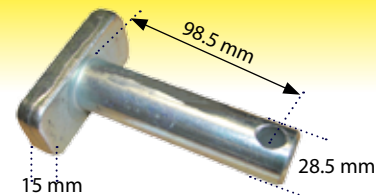

Bottom Fork Lift Link Pin CBM Type 28.5mm

 **CBM** SpA
COSTRUZIONI MECCANICHE

41744

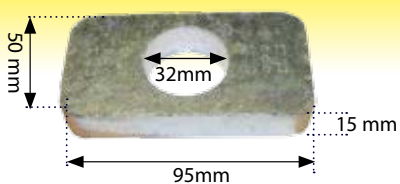

Bottom Fork Plate CBM Type 32mm hole

41745

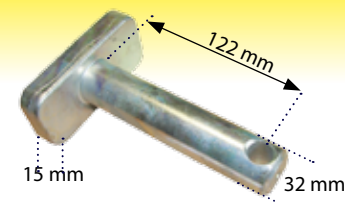

Bottom Fork Lift Link Pin CBM Type 32mm

 **CBM** SpA
COSTRUZIONI MECCANICHE

Linkage

62092



Levelling Box Fork 3000
Suits 61858 Pin is 41748 **

22mm Ø



6968

Lift Threaded Rod
3000 6000
180mm long x
26.5mm

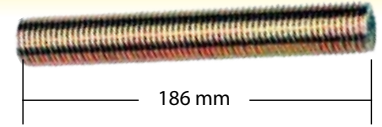

62091



Eye Bolt Assembly 3000 Levelling Box ***Suits 61858***

61858

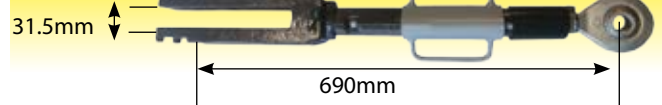

Levelling Box 3050 3060 3065 6120 6130 6140
6235 6245 6255 6260 6265 6270 6280 6290
690mm long from centre of holes 22MM Pins



62063

Levelling Box 3645 3655 3670 3690 8120 8110 8130 8140
8150 8160 37mm Gap between Forks 770mm long from
centre of holes
OE Ref: 3616478M91

62090



Lift Arm 5400 3000 Series RH - Hook End
Also fits 3095

62089

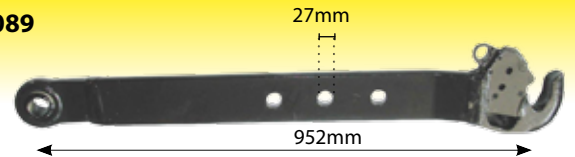

Lift Arm 5400 3000 Series LH - Hook End

52143



Levelling Box Case 5120 - 5150 5250 - 5250
Maxxum 5100 & 5200 & MX80 - MX135
(530-675mm)



DRSP30033



Pick Up Hitch Hook ISO 60mm
115mm btw Holes



62309



Stabiliser 6400 7400 480 - 450mm Long
Automat CBM Original



41739



Eye bolt Ring Quick Release Chain 3000
5400

52913

Linch Pin Safety
8mm











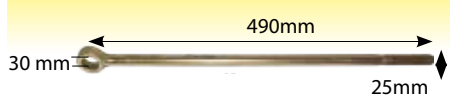
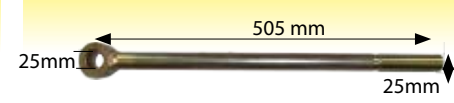
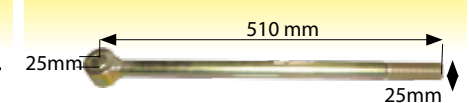
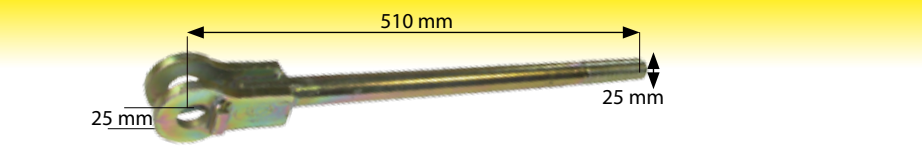

53027

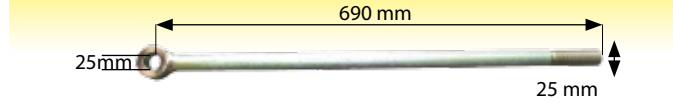
Linch Pin Safety
10mm

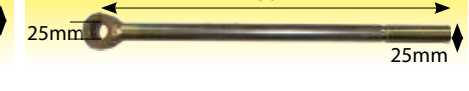
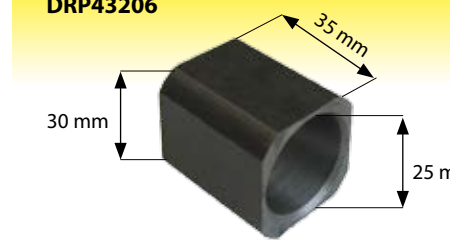

Lift Rods

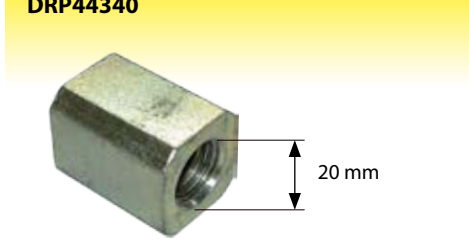
<p>DRP79052</p>  <p>Lift Rod Zetor UR3</p>	<p>DRP00001</p>  <p>Lift Rod Assembly John Deere & Bushing 20mm</p>	
<p>DRSP75265P</p>  <p>Lift Rod Fiat 90-90 Renault P25</p>	<p>DRP79044</p>  <p>Lift Rod 3000 3100 6100</p>	<p>DRP79040</p>  <p>Lift Rod 3600 8100</p>
<p>DRSP6055</p> <p>Lift Rod Ford TM 60</p>		
<p>DRP79049</p>  <p>Lift Rod Same Titan</p>	<p>DRP79047</p>  <p>Lift Rod Case 844 955 956 1055 1055</p>	
<p>DRP79046</p>  <p>Lift Rod John Deere 7600 7700 7800</p>	<p>DRP75302P</p>  <p>Lift Rod Case Maxxum</p>	
<p>DRSP75298P</p>  <p>Lift Rod Subassy (Pass)</p>	<p>DRP75269</p>  <p>Lift Rod</p>	<p>DRP79032</p>  <p>Lift Rod John Deere 6810-6910</p>
<p>DRP43206</p>  <p>Spacer 35mm high</p>	<p>DRP44341</p>  <p>Nut Lift Rod 25mm Diameter</p>	<p>DRP44340</p>  <p>Nut Lift Rod 20mm Diameter</p>

'O' Rings

1127



Box of Imperial "O" Rings

BS020	BS132	BS172	BS256	BS346
BS021	BS134	BS173	BS257	BS347
BS023	BS138	BS211	BS259	BS425
BS024	BS140	BS212	BS260	BS427
BS026	BS143	BS213	BS261	BS428
BS027	BS145	BS214	BS262	BS431
BS029	BS146	BS216	BS263	BS432
BS030	BS150	BS219	BS266	BS433
BS031	BS151	BS220	BS268	BS434
BS033	BS151	BS221	BS269	BS435
BS034	BS152	BS222	BS270	BS436
BS036	BS153	BS224	BS272	BS437
BS039	BS154	BS225	BS273	BS438
BS041	BS156	BS226	BS274	BS439
BS043	BS158	BS227	BS325	BS440
BS042	BS159	BS228	BS326	BS441
BS044	BS160	BS229	BS327	BS443
BS045	BS161	BS238	BS328	BS444
BS046	BS162	BS241	BS329	BS445
BS047	BS163	BS242	BS330	BS446
BS048	BS164	BS243	BS333	BS447
BS049	BS165	BS244	BS334	BS448
BS050	BS166	BS426	BS336	BS448
BS118	BS167	BS247	BS340	BS449
	BS168	BS249	BS341	BS450
	BS170	BS250	BS342	BS807
	BS169	BS251	BS344	BS812
	BS171	BS253	BS345	BS814
		BS255		

365784



O Rings

Brake Components - Cup Seals

7023 - Cup Seal (41.3 x 9.1) Normal SRB
7071 - Cup Seal (17.4 x 6.6) Normal SRB
7120 - Cup Seal (15.8 x 7.1) Normal SRB
7128 - Cup Seal (22.2 x 8.0) Normal SRB
7132 - Cup Seal (25.4 x 7.4) Normal SRB
7136 - Cup Seal (28.6 x 7.2) Normal SRB
7140 - Cup Seal (31.7 x 7.2) Normal SRB
7142 - Cup Seal Normal SRB 33.3 x 7.9
7144 - Cup Seal (34.9 x 8.1) Normal SRB
7148 - Cup Seal (38.1 x 8.2) Normal SRB
7156 - Cup Seal (44.4 x 9.5) Normal SRB
7164 - Cup Seal (50.8 x 9.4) Normal SRB



N7140 - Cup Seal (31.7 x 7.2) Mineral
N7142 - Cup Seal (33.3 x 7.9) Mineral
N7148 - Cup Seal (38.1 x 8.2) Mineral

Spool Valves

51615



Spool Valve Monoblock 1/2" BSP 4 Bank Double Acting, Double Acting, Double Acting Single Acting

51613



Spool Valve Monoblock 1/2" BSP 3 Bank Double Acting, Double Acting, Single Acting *** In Kit 51660 ***

3525



Spool Valve Monoblock 3 Bank 3/8" Double Acting Double Acting Single Acting c/o Relief Valve

53101



Spool Valve Monoblock 1/2" BSP 1 Bank One Bank Double Acting

51614



Spool Valve Monoblock 1/2" BSP 2 Bank Double Acting, Single Acting

62744



Selector Valve with Spool Valve Monoblock 1 bank 3/8" BSP

51660

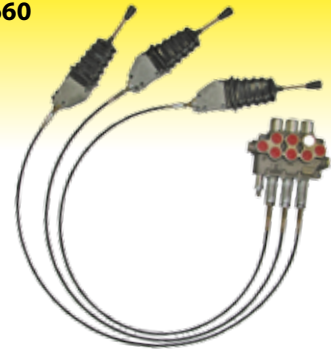

Valve Block Fitting Kit, Cable & Handle 2.0 m

3874



Solenoid Six Port 1/2" c/o Din Plug 90 L/PM 65 WATT IP65 1/2 BSP

51768



DIN Connector For Solenoid Valve

52918



Dowty Washer M18

52920

Hydraulic Accumulator 250 bar M18 x 1.5 Connection ** Kits 51714 & 53313 **



52922

Clamp for Hydraulic Accumulator ** Suits 52920 **



52921

Ball Valve High Pressure 3/8" BSP



Kit=51714

51714

Hydraulic Actuator Easy Ride 250 Bar



53162

Solenoid Valve For 53313



53313

Hydraulic Actuator Easy Ride Solenoid Control



Joystick Parts



51144
Joystick Lever with Button & Cable Fitted



51278
Push Button for Joystick c/o Waterproof Cover



51235
Joystick Without Push Button



51146
Knob C/O Switch to suit Joystick 51144



51862
Base to Suit Morse Joystick 51144



53156
Push Button For 51235 Joystick



3744

Cable Fitting Kit - Female Splined

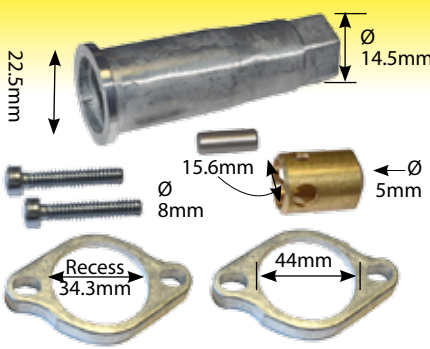

3720

Cable Fitting Kit - Spade Spool - Male



51333

Cable Connection to Suit 3118



53157

Nut Hex For Joystick Button 51278



53158

Lock Washer For Joystick Button 51278



53159

Locking Ring For Joystick Button 51278

Kontak Parts

3440



Kontak Slice
Single Acting

1522



Double Acting
Kontak Slice

59989



Kontak End Plate John
Deere Closed Centre

1954



Kontak End Cap

1091



Kontak Handle Bracket

1278



Pin & Link
Kit Kontak
Handle

4190



3/8' x 7 1/2' Stud

3534



Kontak End Cap
Long

3116



O-Ring Kit Kontak Slice
Intersection

2447



Piston Seal Kit Kontak New
Type

3743



MORSE
ACTUATOR

2570



Kontak
Handle
Kit

51877



Morse Actuator
To Suit Hook
Type Cable

1204



Handle Kontak
Standard

Fitting Kit, Cable & Handle

Part No	Mtr
51663	1.5
51662	2
51671	2.5

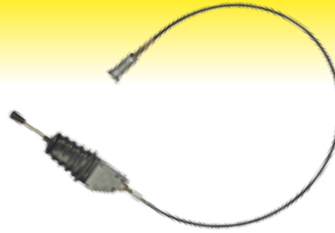

Quicke Loader Cable Threaded Ends

Part No	mm
53011	1200
53009	1500
53010	2000
53012	2400

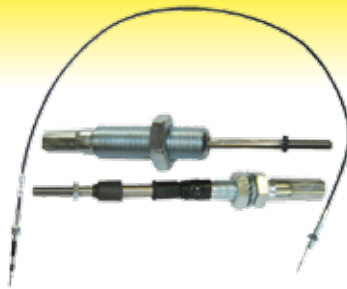

Quicke Loader Cable Ball & Eye Piece

Part No	mm
53013	1200
53000	1400
53001	1600
53002	1800
53003	2000
53004	2200
53005	2400
53006	2600
53007	2800
53014	3000
53008	3200

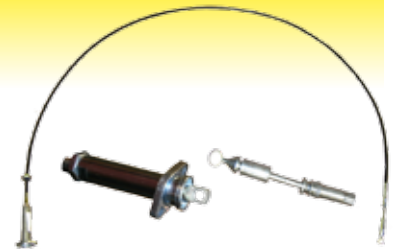

Morse Cable

Part No	Mtr
3736	2.5
3732	1.5
3731	2
3762	3

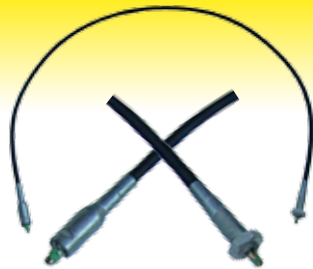

Morse Cable Hook Type

Part No	Mtr
51872	2.0
51873	2.5

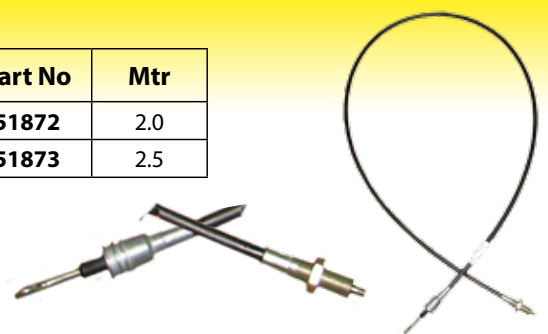

Cable for Joystick

Part No	Mtr
51145	2
51337	1.5
51220	2.5



Loader Cable

59336



Cable Loader John Deere 531 - 551 533 - 583
631- 651- 661 633 - 653 - 663 731 - 751

Hydraulic Pump

2495

Hydraulic Pump to suit 3711



Hydraulic Filters

2411



Hydraulic Filter In line 3/4"

51888



Hydraulic Filter Head One Way 3/4 VCC

2146



Hydraulic Filter UCC Fits JCB Forklift & Loader

2415



Hydraulic Filter Assembly 1 1/4"

51889



Hydraulic Filter Head One Way 1 1/4 VCC ** Kit with Filter is 2415 **

1577



Hydraulic Filter Hedge Cutter

1595



Hydraulic Filter Hedge Cutter

Gauges

3070

Gauge Pressure Small
5800 PSI Glycerine Fille



4378

Gauge Pressure 580 PSI
Glycerine Filled



3625

Gauge Oil Pressure 140
PSI Glycerine Filled



4470

Rubber Pressure
Gauge Protector



Valves

3870

1/2" Non Return Valve



53301

Regulator Flow Control 1/2" BSP



Adaptors

2257

Hydraulic Gauge
1/4" Barrell Adaptor



2258

Adaptor to suit
Hydraulic Gauge



1825

Adaptor 1/4" BSP x
3/8" BSP



1852

Adaptor 1/2" x 1/4"
BSP



1893

UCC Oil Filler Cap
Assembly



2033

Rotary Shut Off
Valve / Tap 1/2"
BSP



2749

Shut off Valve & Tap
3/8" BSP



Standard Quick Release Couplings

		3/8" BSP	1/2" BSP	3/4" BSP	1" BSP
Male		1274	1985	1578	
Female		1275	1984	3624	
Repair Kit		1374	3297		
Dust Cap Female		1533	1439	1662	1665
Dust Cap Male		1612	2759	1613	1714
Anchor			51380		

Pressure Washer Couplings

		3/8" BSP	1/2" BSP
Male		2754	
Female		2753	2750
Male Hose Tail		2752	

Flat Faced Couplings

1/2"

51731



Connector 1/2" Male Flat Faced

51732



Connector 1/2" Female Flat Faced

3/8"

53751



53751 Quick Release Coupling Flat Faced Male 3/8"

53750



53750 Quick Release Coupling Flat Faced Female 3/8"

Breakaway Quick Release Couplings

2559



1/2' Double Breakaway Kit

2560



Quick Release Coupling Assembly 1/2" 1/2' Single Breakaway Kit

6957



Quick Release Coupling 1/2" 3/4" JIC Thread

3272



Quick Release Coupling 1/2" BSP Female Push P

1576



Quick Release Coupling Plate 1 Hole

1744



Quick Release Coupling Plate 2 Holes

3968



External Circlip for 3272 - 1 1/2" 38mm

Ford

Massey

3029G



Quick Release Coupling Spool Valve Ford

51355



Seal Kit to Suit 3029G Ford Coupling

53488

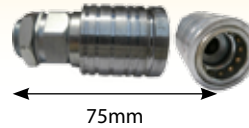

Quick Release Coupling Hydraulic 1/2 Female M22 x 1.5 Thread 75mm Long

6116



Quick Release Coupling 300 3000 M22 Seal=42094

41633

Quick Release Coupling Ford TS TM 60 M22





John Deere

59830

Quick Release Coupling John Deere 10/20's Deluxe Version



Trailer Brake Coupling

	3/8" BSP	1/2" BSP	M18	M20	Photo
Female	2696	2624			
Male Brake Line		2748		2747	
Female Brake Line			2625		

Coupling Dowty

Male	Female	Dust Cap Male
51721 	51722 	51725 

Exactor

Male	Female	Dust Cap Male	Locknut
51726 	51727 	51730 	51728 

Bracket

61981
Bracket Multi Purpose
For Hydraulic
Couplers



BSP Female Diverters



2756

Diverter Valve 3/8' BSP Female

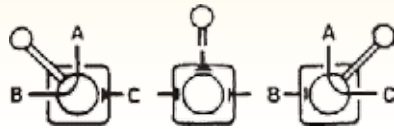

2757

Diverter Valve 1/2" BSP Female

Dowty Washers

Part No.	Size
61792	1/8"
1693	1/4"
1527	3/8"
1526	1/2"
1528	5/8"
1525	3/4"



Hydraulic Hoses

Part No.	Size
2009	3/8"
2010	1/2" (2 Wire)
3570	3/4" (2 Wire)



Tipping Pipes

1766

Tipping Pipe 24" - 1/2' Hose







Reusable

BSP Hydraulic Fittings





	Hose	Male	Female	90°
1/4" BSP	1/4"	1787A	1787	
3/8" BSP	3/8"	1789	1788	1789A
1/2" BSP	1/2"	1791	1790	1792
5/8" BSP	5/8"		1793	1795
3/4" BSP	3/4"		1796	1797

JIC Hydraulic Fittings

Couplings	Hose	Male	Photo	Female	Photo
9/16" JIC	3/8"	1806A		1801	
3/4" JIC	1/2"	1806			
1 1/16" JIC	3/4"	5312			
1 3/16" JIC	3/4"			5309	

JIC 90° Couplings

Couplings	Hose	Female	Male	
1 1/16"	3/4"	5311		
3/4"	3/8"		1805	
7/8" 90	1/2"		1808	

Metric Fittings

Couplings	Hose	Female
M18	3/8"	2808
M22	1/2"	2806



BSP Adaptors



Size	Male/Male	Female/Female	Male/Female
3/8" x 3/8"	1816	1861	
3/8" x 1/2"	1853	1859	1777 (3/8" Male x 1/2" Female)
3/8" x 5/8"	1854	1855	
3/8" x 3/4"	1848		
1/4" x 1/4"	1828	1862	1870
1/4" x 3/8"	1825	1860	
1/4" x 1/2"	1852		
1/4" x 3/4"	1851		
1/2" x 1/2"	1815	1856	1864
1/2" x 5/8"	1850		
5/8" x 5/8"		1895	1863
3/4" x 5/8"	1846		
3/4" x 3/4"	1817	1858	1867
7/8" x 5/8"	1823		
3/4" x 1"		1865	
1" x 1"		1857	
1" x 1 1/2"	1849		

Adaptors

Couplings	Male/Male
1 1/16" JIC x 1 1/16" JIC	3616
1 5/16" JIC x 1 5/16" JIC	3615



JIC/BSP Adaptors

Couplings	Male/Male
3/8" BSP x 1/2" JIC	51955
9/16" JIC x 3/8" BSP	1827
9/16" JIC x 1/2" BSP	1826
3/4" JIC x 3/4" BSP	1989



Metric/BSP Adaptors

Couplings	Male/Male
18mm x 3/8"	2402
M22 x 3/8"	2403
M22 x 1/2"	2386



BSP/JIC Adaptors

Couplings	Male/Male
1/2" BSP Male x 3/4" JIC Male	1868



Elbows



1135
3/8' x 3/8' BSP 90° Comp. Elbow M & F



1198
Elbow Mass 1/2" x 1/2" BSP 90°

Pipe Joiners

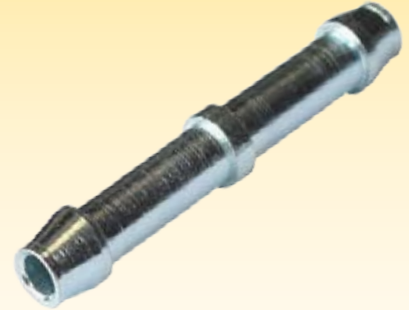

53900 suits 3/16" ID Hose

53901 suits 1/4" ID Hose

53902 suits 5/16" ID Hose

53903 suits 3/8" ID Hose

53904 suits 1/2" ID Hose

53905 suits 5/8" ID Hose

Bulkhead Adaptors

Size	Part No.
1/4" BSP	2645
3/8" BSP	1560
1/2" BSP	1170



T Pieces

Size	Part No.
3/8" BSP Male	1269
1/2" BSP Female	3136



Female



Male

Tube Couplings



53906 Brass Olive 5/16"

53907 Brass Olive 3/8"

Bulkhead Adaptors

Couplings	Male/Male
3/8" BSP	4271
1/2" BSP	4270



Size	Part No.
3/8" BSP	3294
1/2" BSP	3271



One Piece

Crimp on 3/8" BSP Fittings to suit 3/8" hose



Description	Part No.	Photo	Description	Part No.
90° Sweep	2736		90° Sweep	2739
45° Sweep	2737		45° Sweep	2740
Female Parallel	2731		Female Parallel	2738
Male Parallel	2732		Male Parallel	2730

Crimp on 1/2" BSP Fittings to suit 1/2" hose

9/16" JIC Fittings to suit 3/8" hose

Description	Part No.	Photo
9/16" JIC Female	2742	
9/16" JIC Male	2741	
9/16" JIC 90° Sweep	2735	
3/4" JIC	2743	

3/4" JIC Fittings to suit 1/2" hose

Description	Male	Female	Photo
3/4" JIC 90° Compact	2745		
3/4" JIC	2744		
3/4" JIC		2746	



Date:..... No. of Pages:.....

Name of the Rep..... A/C Number:.....

From:..... e-mail.....

Phone No.:..... Fax No.:.....

Please quote for the following parts - Quotation Number :

I wish to confirm the following order on Quotation Number:

Please supply the following parts:

Please photocopy this page

Please do not remove this page

Qty	Part No.	Description	Unit Price
1.			
2.			
3.			
4.			
5.			
6.			
7.			
8.			
9.			
10.			
11.			
12.			
13.			
14.			
15.			
16.			
17.			
18.			
19.			
20.			
21.			
22.			
23.			
24.			

Comments:

Customer Signature: _____ **Rep's Signature:** _____

Tel No: + 353 44 934 1638

e-mail: info@qtponline.com, www.qtponline.com

Page of

Radiator Caps

2083



Radiator Cap Massey Ferguson & Ford 10 Lb
OEM Ref: E2NN8100BA

61838



Radiator Cap Massey Ferguson 10 lb Long Reach

1874445



Radiator Cap 200 500
OEM Ref: 187445M93

6483



Radiator Cap Lid 600
OEM Ref: 1427773M92

Fuel Tank Caps

61290



Fuel Tank Cap 20 TVO

8002



Fuel Tank Cap Metal 100 Series David Brown
OEM Ref: 81718153

1876534



Fuel Tank Cap 500 690
OEM Ref: 1876534M91

61141



Fuel Tank Cap 3000
6100 8100
OEM Ref: 3041489M4

6021G



Fuel Tank Cap 300S - Non Lockable
OEM Ref:1695732M1

61711

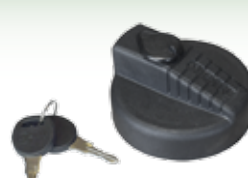

Fuel Tank Cap 300's Lockable Diesel
OEM Ref:1695732M1

62470



Fuel Tank Cap Lockable
3000 3600 8120 - 60

62147



Fuel Tank Cap 4225 - 4270
8210 - 8260
OEM Ref: 3782340M1

OEM

Oil Filler Caps

768300



Transmission Oil Filler Cap Gearbox
OEM Ref: 181467M1

2487841



Engine Oil Filler Cap
OEM Ref:734962M91

6142



Transmission Oil Filler Cap 600 300
OEM Ref: 3595359M92

61492



Engine Oil Filler Cap
399 3100 3600 3085
3095 Twist Type
OEM Ref: 748219M1

61493



Engine Oil Filler Cap
3100 3600
4200 4300
Screw Type
OEM Ref:
3641889M1

62445



Oil Filler Cap 595 698
1080 1085 298 592
OEM Ref: 897105M1

Ford Radiator Caps

48808



Radiator Cap Fordson N's
2N/8N/9N (1943-1952)

41805



Radiator Cap
Fordson

41228



Radiator Cap Fordson
Super Major
OEM Ref: 81711544

4023



Radiator Cap Ford 7lb
OEM Ref: E2NN8100AA
83935904

4717



Radiator Cap Ford
13 Lb
OEM Ref:
E2NN8100BA

41877



Radiator Cap Ford TM120 -
TM190 22lbs
OEM Ref: 82033782

42029



Radiator Cap TM MXM
OEM Ref: 87306788

Fuel Tank Caps

41225

Engine Oil Filler Cap Dexta / Super
Major OEM Ref: 81717845



41473

Fuel Tank Cap Super Major
OEM Ref: 81718153



4079



Fuel Tank Cap Ford - All
Models
OEM Ref: 81811847
83904042

2775



Fuel Tank Cap Ford 7610
OEM Ref: E4NN9030AB

409660



Fuel Tank Cap Ford 40
Auxillary (91-98)
OEM Ref: 81874137

Oil Caps

1500



Oil Filler Cap Ford Power
Steering
OEM Ref: D2NN3A514B

4080



Oil Filler Cap
Ford Engine/
Transmission
OEM Ref:
83907851

4166



Transmission Oil Filler Cap
Dipstick Ford
OEM Ref: 81817892

41757



Filler Cap Ford - Transmission
OEM Ref: 957E7010

Fiat Oil Cap

7565

Engine Oil Filler Cap Fiat
100/90, Case JX, U
OEM REF: 4232606



Fuel Tank Cap

7285

Fuel Tank Cap Fiat
OEM REF: 5105346



John Deere Radiator Caps

59402



Radiator Cap John Deere 1640 - 3140
OEM Ref: AL38374

59394



Radiator Cap John Deere 940 3140
1030 1630 2020 2120 3120
OEM Ref: AL38374

59389



Radiator Expansion Tank Filler Cap
1350-2450 2650-3650
OEM Ref: AL58894

59395



Radiator Cap John Deere
4040 4840 4050
OEM Ref: AR76619

59392



Radiator Expansion Tank Cap
John Deere 6000
OEM Ref: AL78005

59397

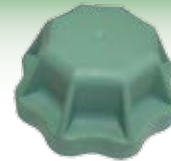

Radiator Cap John Deere 6000
6010 6020 Filler
OEM Ref: AL76661

59400



Radiator Cap John
Deere 7000 - 7020
OEM Ref: RE43593

Fuel Tank Caps

3158



Fuel Cap John Deere
40 50
OEM Ref: AL34678

59840



Fuel Tank Cap John Deere
00 10 20 Lockable
OEM Ref: AL113087

59436



Fuel Tank Cap John
Deere 00 10 20 No
Lock
OEM Ref: AL113086

Oil Caps

59391



Oil Cap John Deere 3050
3350 3640 2140 1640 2040
OEM Ref: R90788

59390



Oil Cap John Deere 2040
- 3640 Filler Neck
Up To Serial Number
429999 1350 - 2450 2650
- 3650 All 6000 6010
6020
OEM Ref: R80136

59401



Oil Filler Cap Engine
John Deere

59361



Oil Filler Cap Back End John
Deere With Dipst 6100 - 6600
6010 - 6610 6020 - 6620
OEM Ref: AL163619

Zetor Radiator Caps

5029

Radiator Cap Zetor
8011
OEM Ref: 84013502



Fuel Tank Caps

2503

OEM

Fuel Tank Cap Zetor 6718
8011
OEM Ref: 955235



Renault Radiator Cap

780016

Radiator Cap Renault MWM
OEM Ref: 0853058000

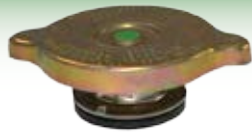

Fuel Tank Cap

59388

Fuel Tank Cap Renault
OEM Ref: 7700021448



IHC Radiator Caps

52133

Radiator Cap IHC
Round



52020

Radiator Cap IHC c/o Cover
OEM Ref: 1500626C92



2663

Fuel Tank Cap IHC
OEM Ref: 538063R1



52697

Fuel Tank Cap IH 42's
OEM Ref: 1500254C1

SEAL=52698

OEM

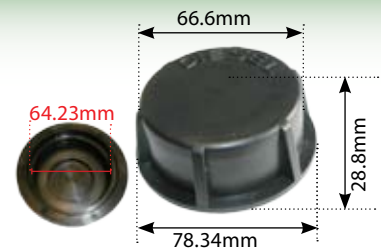

Toyota Radiator Caps

51670

Radiator Cap Toyota 0.9 BAR



David Brown Oil Filler Cap

52731

Oil Filler Cap David
Brown



Exhausts - Clamps - Caps

Weathercaps



- 51807** 2" 51mm
- 51204** 2 1/4" 56mm
- 51199** 2 3/4" 70mm
- 51198** 2 5/8" 66mm
- 51196** 3 1/2" 89mm
- 51195** 3 1/4" 82mm



- 62801** 1 3/4" 45mm
- 59290** 3 3/4" 100mm



- 3415** 70mm 2 3/4"
- 3264** 82mm 3 1/4"



- 61579** 240 43mm
- 3169** 285 Rain Cap

Raincaps



- 62121**
Exhaust Clamp
165 - OE Type
59mm



- 61298**
Exhaust Clamp 35 135
Lower Horizontal



- 62105**
Exhaust Clamp for
Rear View Mirror 35
Exhaust



- 907155**
Washer 100 200 Exhaust
Clamp Square



- 180070**
Exhaust Clamp 20 TVO
Heavy Duty

Stainless Steel Rain Caps



- 53350**
1 3/4"
44.45mm
OD



- 53351**
2 1/4"
57.15mm
OD



- 53352**
2 1/2"
63.5mm
OD



- 53353**
2 3/4"
69.85mm
OD



- 53354**
3"
76.2mm
OD



- 53355**
3 1/2"
88.9mm
OD



- 53356**
4"
101.6mm
OD



Nylon Buffer

Fuel Pumps

53787

Fuel Transfer Pump 12 Volt
Submersible 30 Litres per Minute

- 33litres per minute
- Pumps 5 meters high
- Worked off any 12v battery
- Removable filter for cleaning
- 40mm diameter
- CE approved



53809

Fuel Transfer Pump 12 Volt External 40 Litres per Minute

51475

Fuel Pump Lister
SR Engine



51476

Fuel Pump Lister HL4/HR
4 6 Cylinder



51477

Fuel Lift Pump Cummins
B's - Diaphragm Pump Case
Maxxum 5120 5130 5140



51478

Fuel Pump Land Rover 200 TDI



51479

Fuel Pump Land Rover 300
TDI



51484

Fuel Lift Pump Perkins 4/99
4.108 A4/107



Diesel Stop Solenoids

1976



Solenoid 12v Diesel Stop
BOSCH Type

2038



Solenoid Diesel Stop
12V CAV Type 2 Spade
Connections

1992



Solenoid Diesel Stop
12V CAV Type Single
Nut Connection

62727



Solenoid 12V Diesel
Stop 42s 54s Plug In
Type

Valve Non Returns

53317

Valve Non Return 6mm



59906R

Valve Non Return 8mm
59906 is genuine



53318

Valve Non Return 10mm



Fan Belts

Massey Ferguson



Part No	Models	OE Ref	Size mm
62141	Fan Belt 20D 35 Narrow - 17 X 985 **V771 is the wide belt**		17 x 985
V771	Fan Belt 20D 35 4 Cylinder - 20x13x985 **62141 is the Narrow belt**	826960M1	17 x 985
2235	Fan Belt 35 3 Cylinder - 13 X 1175	828729M1	13 X 1175
2240	Fan Belt 135 7600 Double Pulley 13 X 1225 **Also 3000 Series Air con Belt**	890982M1	13 X 1225
2255	Fan Belt 165 188 Zetor Crystal - 13 X 1275	1447317M1	13 X 1275
4379	Fan Belt 365 375 390 - 13 X 1490	1693745M1	13 X 1490
6964	Fan Belt 399 Phaser - 13 x 1520 - PAIR	3614706M92	13 x 1520
6765	Fan Belt 399 A6.354.4 Pair	3595070M91	13 X 1440
3790	Fan Belt 200 500	81822583	13 X 1400
2240	Fan Belt 135 7600 Double Pulley *Also 3000 Series Air con Belt	890982M1	13 X 1225
4380	Fan Belt 698		13 X 1500
1244	Fan Belt 698T Pair	1687610	10X1500
4381	Fan Belt 699 Pair	1688216M91	13 X 1445
2300	Fan Belt 2640 2680 Pair	3045111M91	13 X 1500
6766	Fan Belt 2640 3080 3090 Pair	3381364M91	13 X 1515
6898	Fan Belt 3125 3635 3645 6190 8110 Pair	3582953 M91	13 X 1575
429968	Fan Belt 42's With Air Conditioning Pair Green Engine 4225 4235 4240 4245 4255 4265	3817582M1	13 x 1400
429969	Fan Belt 42's High Visibility Tractor Green Engine,4225 4235 4240 4245 4255 4265	3815256M1	13 x 1295
429970	Fan Belt 42's High Visibility With Air Conditioning Green Engine 4225 4235 4240 4245 4255 4260	3815257M1	13 x 1295
62545	Fan Belt 5445 5455 5460 c/w Air Conditioning	3389525M1	13 x 1100
62534	Fan Belt 5445 5455 5460 c/w Hi Vis	3780604M91	13 X 1295
429973	Fan Belt 4215 4220 Pair	3637598M91	13 x 1275
61380	Fan Belt 6245/6255 & 6260/6290 Pair 4260/4270 - 1405mm Long	3780606M91	13 x 1405
62538	Fan Belt 6260 6270 6280	3780138M91	13 X 1390
62539	Fan Belt 6260 6270 6280 c/w Air Conditioning	3386214M1	13 X 1150
62536	Fan Belt 6460 6470	4274692M91	13 X 1420
62532	Fan Belt 6460 6470 c/w Air Conditioning	4275784M1	20 X 1060
62533	Fan Belt 6475 6480	3779379M91	13 X 1425
2260	Fan Belt 240 Massey Ferguson 50B	3637306M91	13 X 1300

Fan Belts

Ford



Part No	Models	OE Ref	Size mm
1936	Cogged Belt Dexta		12.5 X 1125
2275	Fan Belt 2000 3000 4000 5000		13 X 1375
3790	Fan Belt 500's/Ford 600's S/P	81822583	13 X 1400
3370	Alternator Belt Ford 6600 7600 Double Pulley	D5NN10C3181C1	13 X 765
2240	Fan Belt 135 / 7600 Double Pulley		13 X 1225
4423	Fan Belt Double Pulley Ford 7600 7610	D6NN8620A	13 X 1145
4456	Fan Belt Ford 7610 7810 Short - AVX13 x 800	83948803	13 X 800
4254	Fan Belt Ford 7810 Late - Long	86514611	13 X 1150
4794	Fan Belt Ford 8210 TW5 15 25 35	89625879	13 X 1470
402914G	Fan Belt Ford 40 TS110 TS115 w/o Air Con Original	82850750	6PK 2217
402915G	Fan Belt Ford 40 TS110 TS115 c/w Air Con Original	82850752	6PK 2254
404857G	Fan Belt Ford TS 80 90 100 w/o Air Con Original	82850751	6PK 2225
404859G	Fan Belt Ford 81/82/83/8560 w/o Air Con Original	87316555	8PK 1475
41051G	Fan Belt Ford 8160/8260/8560/TM C/W Air Con Original	87309962	8PK 1951
41635	Fan Belt Ford TSA 100-135, T6000	4899178	8PK 1551
41635G	Fan Belt Ford TSA 100-135, T6000 Original	4899178	8PK 1551

Fan Belts

Fiat



Part No	Models	OE Ref	Size
7310	Fan Belt Fiat 880	4712148	10 X 1275
7311	Fan Belt Fiat 80-90	4796650	10 X 1180
7312	Fan Belt Fiat 90-90 140-90 Pair	4796328	10 X 1140

Zetor



Part No	Models	OE Ref	Size
2255	Fan Belt Zetor Crystal	98419479	13 X 1275
1237	Fan Belt Zetor 8111		10 X 1225
B45	Fan Belt Zetor - up to 6718	974312 974318	
59685	Fan Belt Zetor 10 x 1113 - V Belt		10 X 1113

Leyland



Part No	Models	OE Ref	Size
2260	Fan Belt Leyland		13X1300

Universal



Part No	Models	OE Ref	Size
2032	Fan Belt Universal		12.5 x 1150

Deutz



Part No	Models	OE Ref	Size
3492	DX610-110-85		9.5 x 1560

Fan Belts

Case



Part No	Models	OE Ref	Size
1509	Fan Belt IHC 474 784	3616512M91	13 x 1550
52002	Fan Belt Case 956/1056 w/o Air Conditioning	3218952R1	13 x 1420
52006	Fan Belt Case 4240	1537104C1	13 x 1595
52000	Fan Belt Case Maxxum 5120 5130 MX 100 135 MX 100 - 135	J911558	8PK 1495
52001	Fan Belt Case Maxxum 5130 5140 5150 8PK1460	J911562	8PK 1460
52085	Air Con Belt Case CX70 CX80 CX90	228332A2	13 x 930
59368	Fan Belt Case IH 323 383 423 453 484 540 640 740 743	3144678R1	13 x 1325
52776	Fan Belt Case C90 CX90 C100 CX100	241895A2	10 X 1415
52775	Fan Belt Case Magnum 7120 7150 7210 7250 8PK1700	J911567	8PK 1700
52774	Fan Belt Case MX150 MX170 - 5130 5140 5150 8PK1460	J911558	8PK 1460

David Brown



Part No	Models	OE Ref	Size
3475	Fan Belt David Brown 990/1410	K68073	10 X 1175
52176	Fan Belt David Brown 3 Cylinder	K912196	10 x 1090

Fan Belts

John Deere



Part No	Length	Air Breaks	Air Con	Models	Tension
59907	2190mm	No	Yes	6800 6900	Mech
59907G	2190mm	No	Yes	6800 6900 8PK2190	Mech
59947G	2205mm	No	Yes	6100 6200 8PK2205 Original 6300 6400 6600 & All SE	Mech
59948	2225m	No	Yes	6100 6200 8PK2225 Also fits 6300 6400 6600 2225mm	Hyd
59948G	2225mm	No	Yes	6100 6200 6300 6400 6600	Hyd
59949	1718mm	No	No	6100 6200 6PK1718 6300 6400 6506 6600 Premium 6100 6200 6300 6400 SE models	Mech
59949G	1718mm	No	No	6100 6200 6PK1718 6300 6400 6506 6600 Premium 6100 6200 6300 6400 SE models	Mech
59950	1700mm	No	No	6600 6800 6900 6PK1700 6506 6600 6800 6900 - W/O Air Con	Mech
59950G	1700mm	No	No	66 68 6900 6PK1700 6506 6600 6800 6900	Mech
59889G	1930mm	No	No	6010 6020 4 Cyl 8PK1930 6110 6210 6310 6410 6120 6220 6320 6420	Mech
58676	2200mm	No	No	6800 6900 8PK2200	Mech
59063	2285mm	Yes	Yes	6100 6200 6300 6400 6800 6900	Hyd
59694G	2460mm	No	Yes	6100 - 6610 M/ten 8PK2460 & A/C 6120 6130 SE and Premium Tractors	Mech
59387	2500mm	Yes	Yes	6810 6910 6910S 8PK2500 For 6810 6910 with Air Brake & Air Con 6230 6330 6430 with Air con up to Serial Numb (98-27/64")	Mech
59375	2455mm	No	Yes	6820 c/o Air Con 8PK2455 6820 - 6920S 6230 - 6930	
58675	773mm			Alternator Belt John Deere 6930 - 7530 Premiu	

Fan Belts John Deere



Part No	Length	Air Breaks	Air Con	Models	Tension
59539	2365mm	Yes	No	6810,6910,6910S,6230,6330	Mech
59540G	1900mm	No	No	6810 6910 6910S 6230 6330	Mech
59541	2515mm	YES	Yes	6310, 6410, 6510, 6610, 6520, 6620, 6130, 6630	Mech
59542	1915mm	No	No	6510,6610,6130	Mech
59543	1910mm	Yes	No	6820,6920,6920S,6230,6930	Mech
59544	2375mm	Yes	No	6820,6920,6920S,6230,6930	Mech
59545	2505mm	Yes	Yes	6820,6920S,6930	Mech
59375	2440mm	No	Yes	6820,6920S,6230,6930,2455	Mech



Part No	Length	Air Breaks	Air Con	Models	Tension
59321	1120mm	No	No	2020 2120	Mech
59320	1215mm	No	No	1020 1120 1520 2120 1030 1130 1630 2020 2120 1830 2030 2130	Mech
59319	1328mm	No	No	3120 3130 3030 1640-2040	Mech
59318	1390mm	No	No	2840 3030 3130 X17X1390LP	Mech
59325	1397mm	No	No	2250 - 2850	Mech
59324	1447mm	No	No	3300-3410 2250-2650	Mech
59317	1460mm	No	No	3040 3140 X17X1460	Mech
59323	1473mm	No	No	3100-3210 2350-2850	Mech
59322	1540mm	No	No	3050 3350	Mech

Orbital Units

1447



Orbital Unit 300 3000 - 100
OSP
Note M18 for Hyd Pipes

6907



Orbital Unit 300 3000 125 OSP
M18 Thread
Note M18 holes for Hyd Pipes

4655



Orbital Unit c/o Relief Valve
3/4 JIC 100 OSP

4564

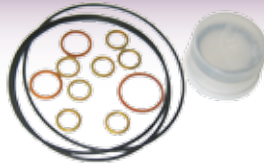

Orbital Unit Seal Kit to Suit
4655

4605



Orbital Unit Ford 40 TS 4WD
M18 -12 Spline 24.25mm Diameter 20mm
high
150 OSP

4857



Orbital Unit John Deere
160 OSP (40 Series)

52184



Orbital Unit Case MXU Puma JX
JXU Maxxum Ford 35 60 TL L M T
TL Series TLA TM TSA TSA Series
STZOR125M170
175 OSP

7808



Orbital Unit Fiat 56 88 90 93 94 Series
100 OSP 1/2" BSP

1504266



Orbital Unit Repair Kit IHC Massey
Ferguson

1810503



Orbital Unit Repair Kit

4620



Orbital Unit Fiat 2 Ram Axle
160 OSP 1/2BSP
Also fits Zetor

4600



Steering Column Assembly Hydrostatic 830mm

62292



Orbital Unit Fitting Kit 675 -698 French
Type
2 x Screw & 4 x O Ring 575 - 590

High Tensile Steel Bolts

UNC

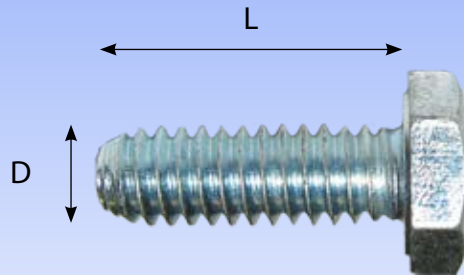

D →	1/4"	5/16"	3/8"	7/16"	1/2"	5/8"	3/4"	7/8"
L ↓								
3/4"	353667	353677						
1"	353669	353679	353691	353698	353723			
1 1/2"	353673	353683	354262	353702	353724	353726		
1 1/4"		7316						
1 3/4"								
2"		353687	353897	353706	354280	353728	354710	4669
2 1/2"	3568	354615	354269	353710	354651	353937	354714	3770
3"	354611	354619	354271	353714	354655	353730	3846	3847
3 1/2"			3289	353718	3203			
4"				353722	3888	354296	354726	
4 3/8"								
4 1/2"						353636		
5"						3896		

3290
Rotavator Bolts
1/2' x 38mm



3629
M14 x 100 Coarse Bolt

High Tensile Steel Bolts

UNF

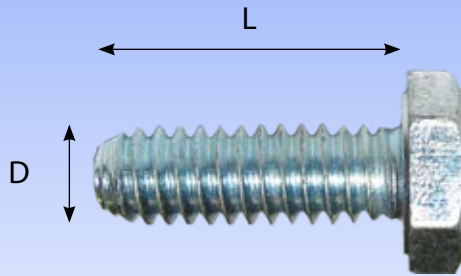

L\D	1/4"	5/16"	3/8"	7/16"	1/2"	5/8"	9/16"	3/4"	7/8"	1"
3/4"	353503	353517								
1"	353505	353519	353538	353559	354393					
1 1/2"	353509	353525	353542	353563		353611				
2"	353513	353527	353546	353567	353599	353615		1025	3849	3199
2 1/2"	354491	353531	353550	353571	353887	353619		3200	3850	
3'	354768	353535	353554	353575	353890	353623	3096	354571	3851	3852
3 1/2"			354505	353579	353602	353627	353564	354573		
4"				353583	353892	353631		894034	2282	
4 1/2"			2876			353636				
5"				353591	4656	353639		354582		
5 1/2"						353643				
6"						3706				
7"						353655				
8"						353894				
9"						357322				
10"						3566				

High Tensile Steel Bolts

METRIC

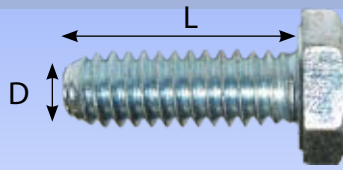

D\L	Type	25	30	40	45	50	65	75	80	100	120	140	150
M3		4475											
M4		4476											
M5				51021									
M6	Chess H. Screw					4479							
	Coarse					3007		3591		3597			
M8	Fine	1550			353605	1551	1552						
	Coarse	3008	2727			3009		3598		3993			
M10	Fine	1553				1558	353654		1564				
	Coarse		3010			3011			3012		3013		
M12	Fine	3664				1565			1566	1569			
	Coarse					3048		3049		3619			
M14	Fine	3684				1873	3737 1.5p			1876			
	Coarse		3637			3757		1424					
M16	Fine	3695		1874		1697	3696			1877			
	Coarse	2728				3014		3015		3016	51622	3017	3018
M18	Fine												
	Coarse					2097			2101	2100			
M20	Fine												
	Coarse						3019		3020	3021			
M22	Fine							353561					
	Coarse												

Metric Nuts & Washer

	Nuts Coarse	Nyloc Nut Coarse	Nuts Fine	Nuts Fine Lock	Flat Washer
					
M3	4481				
M4	4482				
M5	4490	51022			
M6	3001				3515 51948
M8	3002	1987	1579	3723	3517 51945
M10	3003	1699	1580	3724 1.25p	51946
M12	3050	1223	1587	3547 (1.25p) 3734 (1.5p)	51947
M14	1423 3990	1995			51944
M16	3004	1996 53348	3709 353562		51950
M18	2084	353603 53347			51951
M20	3005	1998 53346			51949

52893

Shear Bolts Pack
M8 x 55mm



Nut & Washers

	Unc Nuts 	Unc Lock Nuts 	Flat Washer 	Spring Washer 	UNF Nuts 	Unf Lock Nuts 
1/4"	355564	375107	353754	353441	353918	376446
5/16"	355565 3995	376453	353770	353446	353916	
3/8"	355566	2003	353771	353434	353431	353430
7/16"	355645	376455	353772	353432	353426	353428
1/2"	375098	357560	353773	353439	353437 51932	353438
9/16"					3223	
5/8"	375099	357562	353774	353433	353427	353429
3/4"	375100	3567	353762	353440	353435	353442
7/8"	375101		1061	3661	3439	
1"	1105		1067	3844	3224	
1 1/4"			1366			
1 1/2"			1001			

6916



Washer Metric

Threaded Bars & Steel Keys

Metric Threaded Bars

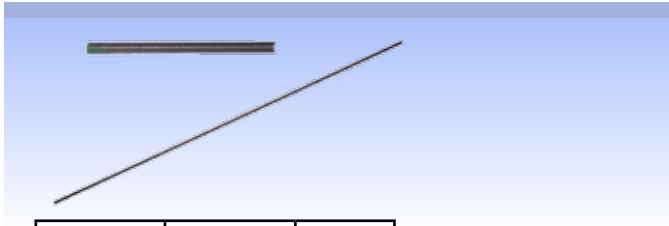

Ref		Mtr
51308	Fine	8
51309	Coarse	10
51310	Coarse	16
51311	Coarse	20

Steel Keys Metric

2684	4 x 4 mm
2685	5 x 5 mm
2686	6 x 6 mm
2669	8 x 7 mm
2673	14 x 14 mm
2674	16 x 16 mm

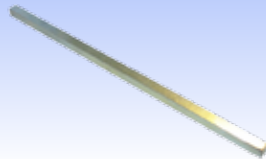

72L12B1RIV
72 Link Cut Chain

All Bars 1 mtr Long

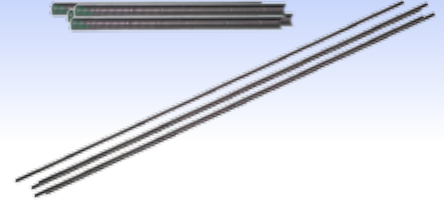

53071	M10 x 50mm
53073	M12 x 80mm



Imperial

2682	1/2 x 1/2'
2677	3/16 x 3/16'
2680	3/8 x 3/8'
2679	5/16 x 5/16'
2681	7/16 x 7/16'

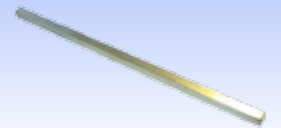

Thread Lock

1043

Loctite Thread
Lock 50 ml



51283

Assorted Pack of Small Split Pins
(55 pcs)

51288

Assorted Pack of Large Split Pins
(50 pcs)



A1497 Split Pin 2.5mm x 38mm



1472 Split Pin 5mm x 75mm

53040

Cotter Pins 6.3 x 75mm

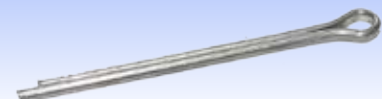

Single Row Ball Bearings

NACHI

60 Series

Ref	ID	OD	WD
60012RS	12	28	8
60032RS	17	35	10
6003ZZ	17	35	10
60042RS	20	42	12
6004ZZ	20	42	12
60052RS	25	47	12
6005ZZ	25	47	12
60062RS	30	55	13
6006ZZ	30	55	13
60072RS	35	62	14
6007ZZ	35	62	14
60082RS	40	68	15
6008ZZ	40	68	15
60092RS	45	75	16
6009ZZ	45	75	16
60102RS	50	80	16
6010ZZ	50	80	16
60112RS	55	90	18
6011ZZ	55	90	18
6012ZZ	60	95	18
60142RS	70	110	20
60152RS	75	115	20
60162RS	80	125	20
60172RS	85	130	22

62 Series

Ref	ID	OD	WD
6200ZZ	10	30	9
62012RS	12	32	10
62022RS	15	35	11
6202ZZ	15	35	11
62032RS	17	40	12
62042RS	20	47	14
6204ZZ	20	47	14
62052RS	25	52	15
6205ZZ	25	52	15
62062RS	30	62	16
6206ZZ	30	62	16
62072RS	35	72	17
6207ZZ	35	72	17
62082RS	40	80	18
6208ZZ	40	80	18
62092RS	45	85	19
62102RS	50	90	20
62112RS	55	100	21
62122RS	60	110	22
6212ZZ	60	110	22
62132RS	65	120	23
62172RS	85	150	28

63 Series

Ref	ID	OD	WD
63002RS	10	35	11
6300ZZ	10	35	11
63012RS	12	37	12
63022RS	15	42	13
6303ZZ	17	47	14
63032RS	17	47	14
63042RS	20	52	15
6304ZZ	20	52	15
63052RS	25	62	17
6305ZZ	25	62	17
63062RS	25	72	19
6306ZZ	25	72	19
63072RS	30	80	21
6307ZZ	30	80	21
63082RS	35	90	23
6308ZZ	35	90	23
63092RS	40	100	25
6309ZZ	40	100	25
63102RS	45	110	27
6310ZZ	45	110	27
63122RS	60	130	31
6312ZZ	60	130	31
63142RS	70	150	35

Bearings

Ref
62072RSC4
62062RSC3
RMS8
30202
218248/10
22211
18690/20



Ref
31308
32306
701242
51113B
31309
32309
53415



Single Row Ball Bearings

High Speed

Ref	ID	OD	WD
6009C3	45	75	16
6207C3	35	72	17
6210C3	50	90	20
6211C3	55	100	21
6306C3	25	72	19

C3 Series

Ref	ID	OD	WD
62062RSC3	30	62	16
62072RSC3	35	72	17
62102RSC3	50	90	20

17 Series

Ref	ID	OD	WD
1762012RS	12	32	10
1762022RS	15	35	11
1762032RS	17	40	12
1762052RS	25	52	15
1762092RS	45	85	19
1762102RS	50	90	20

600-620-630 Series

Ref	ID	OD	WD
6082NSL	8	22	7
6092NSL	9	24	7
6252NSL	5	16	5
6262NSL	6	19	6
6272NSL	7	22	7
6282NSL			
6292NSL	9	26	8

Taper Roller Bearings

302 Series

Ref	ID	OD	IW	OW
30204JR	20	47	14	12
30205	25	52	15	13
30206J	30	62	16	14
30207J	35	72	17	15
30208J	40	80	18	16
30209J	45	85	19	16
30210J	50	90	20	17
30211	55	100	21	18
30212J	60	110	22	19
30213	65	120	23	20
30214	70	125	24	21
30215	75	130	25	22

303 Series

Ref	ID	OD	IW	OW
30302J	15	42	13	11
30303J	17	47	14	12
30304J	20	52	15	13
30305	25	62	17	15
30306JN	30	72	19	16
30307JR	35	80	21	18
30308J	40	90	23	20
30309J	45	100	25	22
30310J	50	110	27	23
30311	55	120	29	25
30312	60	130	31	26
30313	65	140	33	28
30314	70	150	35	30
30315	75	160	37	31

322 Series

Ref	ID	OD	IW	OW
32206JR	30	62	20	17
32207J	35	72	23	19
32208JR	40	80	23	19
32210	50	90	23	19
32211	55	100	25	21
32212	60	110	28	24
32213	65	120	31	27
32214J	70	125	31	27
32215	75	130	31	27
32216J	80	140	33	28

Bearing Inserts & Pillow Blocks

Bailer Bearing Inserts

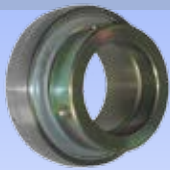

	Ref	ID (MM)
NonGreasable	RAE40NPPB	40
	RAE60NPPB	60
Greasable	GE30KRRB	50

Bearing Inserts



REF	ID
UC206-18	1 1/8"
UC207	35mm
UC20824	1 1/2"

4 Bolt Flange Units



Ref	ID
UCF205-16	1"
UCF208-24	1 1/2"
UCFX10E-32	1 1/4"
UCFX13E-40	1 3/4"
UCF210	

Ram Bushes

Ref	ID (mm)	OD (MM)
4213	17	30
7459	20	35
7306	25	42
4277	40	62
4287	50	75
4309	60	90
4310	70	105



Pillow Block Bearings



Ref	ID
UCP205-16	1"
UCP206-18	1 1/8"
UCP207-20	1 1/4"
UCP208-24	1 1/2"

LOCKING COLLARS

Part No.	Dimensions
53697	Locking Collar ID 3/8" OD 3/4" x 3/8" BZP
53698	Locking Collar ID 7/16" OD 7/8" x 7/16" BZP
53699	Locking Collar ID 1/2" OD 1" x 7/16" BZP
53700	Locking Collar ID 5/8" OD 1 1/8" x 1/2" BZP
53701	Locking Collar ID 3/4" OD 1 1/4" x 9/16" BZP
53702	Locking Collar ID 7/8" OD 1 1/2" x 9/16" BZP
53703	Locking Collar ID 1" OD 1 5/8" x 5/8" BZP
53704	Locking Collar ID 1 1/8" OD 1 3/4" x 13/16" BZP
53705	Locking Collar ID 1 1/4" OD 2" x 7/8" BZP
53706	Locking Collar ID 1 3/8" OD 2 1/8" x 7/8" BZP
53707	Locking Collar ID 1 3/4" OD 2 5/8" x 1" BZP
53708	Locking Collar ID 2" OD 3" x 1 1/8" BZP



53709	Locking Collar ID 10mm OD 20mm x 10mm BZP
53710	Locking Collar ID 15mm OD 25mm x 12mm BZP
53711	Locking Collar ID 20mm OD 32mm x 14mm BZP
53712	Locking Collar ID 22mm OD 36mm x 14mm BZP
53713	Locking Collar ID 25mm OD 40mm x 16mm BZP
53714	Locking Collar ID 30mm OD 45mm x 16mm BZP
53715	Locking Collar ID 35mm OD 56mm x 16mm BZP
53716	Locking Collar ID 40mm OD 63mm x 18mm BZP
53717	Locking Collar ID 45mm OD 70mm x 18mm BZP
53718	Locking Collar ID 50mm OD 80mm x 18mm BZP
53719	Locking Collar ID 60mm OD 90mm x 20mm BZP

TOPPER BLADES

Suits :

Belmac Conor Malone Fleming Wylie Nugent Bridgeway Quinn Rossmore Toppers

53144 Topper Blade 13' x 5/16' 26mm RH	53145 Topper Blade 13' x 5/16' 26mm LH	
53146 Topper Blade 13' x 5/16' 30mm RH	53147 Topper Blade 13' x 5/16' 30mm LH	43257 Topper Blade Major 30mm Hole 270mm Long Clockwise
53148 Topper Blade 13' x 5/16' 32mm RH	53149 Topper Blade 13' x 5/16' 32mm LH	43256 Topper Blade Major 30mm Hole 270mm Long Anticlockwise

3880 Flail Head 1/2" Rotary Spreader Howard	51189 	51188 	37046563
3254 Flail Head 3/8" Howard 	Flail Spiral Pin 11mm Howard 	Flail Plate 4 x 2.5" Howard 	370 x 46.5 x 6.3 Vane Howard

3934 Flail 3/8" x 15 Link Chain Spreader	4998 Flail 1/2" x 15 Link Chain Spreader
---	---

1139 Grab Hook 1/4" 2124 Slip Hook 3/8" 1391 Grab Hook 5/16" 	52894 Grab Hooks 11mm 860kgs	53038 Eye Hook 9mm 700kgs 53037 Eye Hook 8mm 400kgs Throat 11mm 53039 Eye Hook 12mm 900kgs
--	---	---

PZ107
PZ Hay Bob Tine (Narrow Blue)

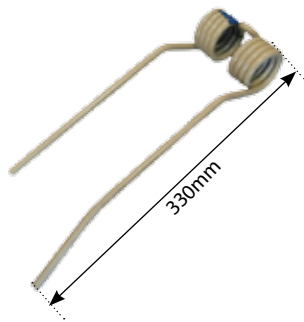

PZ106
PZ Hay Bob Tine (Narrow Yellow)

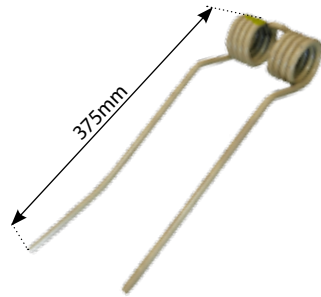

PZ110
PZ Hay Bob Tine (Wide Blue)

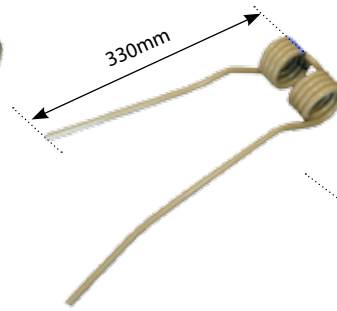

PZ111
PZ Hay Bob Tine Wide Yellow

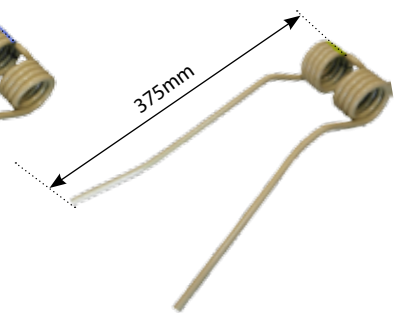

PZ99
PZ Hay Bob Spring LH

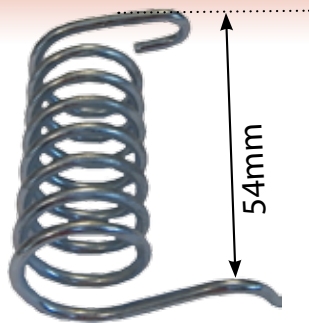

PZ100
PZ Hay Bob Spring RH

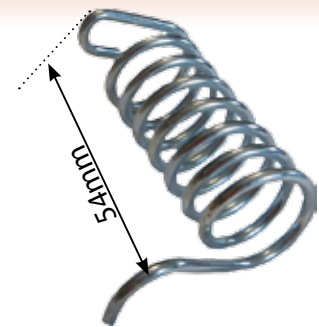

59249



Amalgamating Tape Black
0.25mm Thickness

53126



Silage Tape Black
50mm x 25m

51830



Silage Tape Black PVC
75mm x 20m

3871

Fuel Filter Central
Heating



Airline Fittings Hose Parts

53382



Coupling Y Air 1/2 UNF

1333

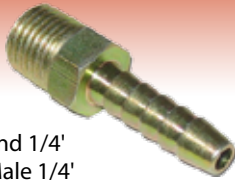

Hose End 1/4' BSPT Male 1/4'

1335



Hose Connection 1/4' Bore D/End

1362



Coupling Y Air Twin

Airline Gauge

51855

Airline Gauge Mk 3 Twin Hold On Open End PCL



	Male	Female
1/4" Bayonet	1276	1328
1/4" BSP	1092	1113



Tyre Parts

2527

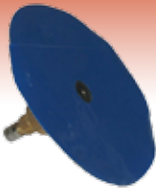

Rear Tube Nozzle

1396



Valve Dust Cap

53020



Rubber Snap In Valve

53021



Brass Valve

51150	45mm	Small Round Patch
3727	60mm	Medium Round Patch
3729	100 x 50mm	Medium Oval Patch
3725	150 x 70mm	Large Oval Patch
3274	130 x 130mm	BP 4 Patch
1118		No. 5 Patch
2522	165 x 165mm	BP 5 Patch
2524	125mm	No. 6 Round Patch
2523	160 x 100mm	No. 7c Oval Patch
3279	200 x 200mm	BPT 0 Patch



51069



Valve Female For Tube

2418



Air Compressor c/o 13ft Hose - 6 Mtr In wooden box ** Connector is 51734 **

51851



Tyre Valve Connector PCL Single clip on open end

52860



Valve Tyre

51551



Air Compressor Hose c/o Fitting (to Tyre) 16 Bar 5.5m Long

51734



Connector for 2418 Compressor

52859



Tyre Repair Kit Tubeless

52861



Tyre Valve Opener

51840

Fibre Washers Assorted
METRIC



52909

Fibre Washer Handy Pack
ImpERIAL



52910

Fibre Washer Vulcanised
Handy Pack



53220

Copper Washer Kit Impe-
rial



53306

Grommets Wiring & Blank-
ing 240pcs



53219

O Ring Kit Metric



53218

O Ring Kit Imperial



53307

Olives Stepped & Barrell
Imperial 500pcs



53290



Wire Brush
Drill Mounted
75 x M14

53291



Wire Brush Drill
Mounted 120 x
M14

53286



Wire Brush Circular
75mm

53292



Wire Brush Twisted Steel

53289



Wire Brush 3 Pack

53285



Blow Gun
Long Nozzle

53288



Vice Grip
Straight Jaw

53283



Turbo Torch
Self Ignite

53308



Drill Bit Tapered
8 - 20mm

59250



Crimping Tool

Assortment Packs

53598

Fuse Blade & Tool Kit 93pcs
Includes Tester and Removal Tool



52900

Fuse Mini Blade Tool Kit 90pcs
Includes Tester and Removal Tool



52902

Pre Insulated Terminal Kit
260pcs



52903

Pre Insulated Terminal Kit
160pcs



53592

Grease Nipple Kit Imperial
110pcs



53593

Grease Nipple Kit Metric
110pcs



53602

Split Pin & Grip Clip Kit 260pcs



53595

Split Pin Kit 1000pcs



53604

Split Pin Large Kit 144pcs



53603

Clevis Pin Kit 60pcs



53599

Grip Clip Kit 150pcs



53606

Circlip Internal External Kit
225pcs



Assortment Packs

53609
Parallel Key Imperial Kit 60pcs



53597
Woodruff Key Metric 80pcs



53605
Spring Ext & Comp Kit 200pcs



53596
Roll Pin Imperial Kit 315pcs



53594
Washer Copper Metric Kit
110pcs



53608
O Ring Kit Imperial 80pcs



53600
Wing Nut Kit 150pcs Metric



53601
Hex Head Drill Screw Kit
200pcs



53607
S Proof & Spring Washers
720pcs



53610
Nut & Bolt SAE Kit 347pcs



53295

Polypropex Sheet
1829 x 1219 x 4mm
Glazing Sheet ** 10
Year Long Life **

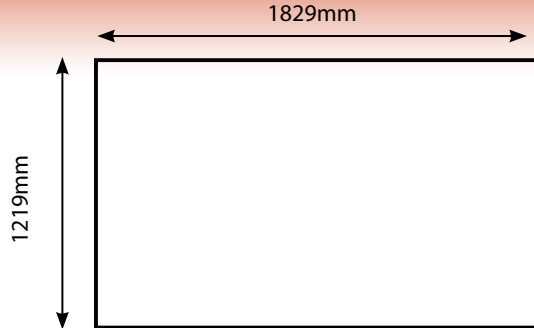

53298

Work Lamp LED
Rechargeable



53893

Bright White LED
Extendable Lamp

Extendable Lamp - 220
Lumens
/Torch - 60 Lumens

Magnetic



1392



Battery Charger 12V
- 12 Amp

53406

Torch 30 Lumen Kryp-
ton Spotlight



53892

Bright White LED Pocket
Lamp

8 LED Pocket lamp -
40 lumens - Magnetic



52885

Antifreeze
Tester



53407

Battery For Torch
30 Lumen Krypton
Spotlight



53076



Radio CD
Player JVC

53277



Radio CD
Player JVC With
Bluetooth

53077



Speakers 200 Watts
10cm x 10cm - PAIR

4537

Rubber Aerial 24cm



52916

Rubber Aerial 40cm



51081

Aerial Extension Cable
150cm



51082

Aerial Extension Cable
200cm



51992

Magnetic Collector 150mm Diamter



52884



Hand Warmers

53015



Wipes Rough & Smooth
24 Pack

51735



Mutton Cloth 100%
Cotton

51876



Safety Goggles

2687

Clear Welding Glass



2076B

Bulb 12v For Hand
Lamp



51823

Welding Rods Mild Steel
3.2mm

51824

Welding Rod Mild Steel
2.5mm

53294

Welding Rods 3.2mm

2576



Piston Ring Compressor 3"

51841



Latex Gloves
Lightly Powdered

53085



Rags 10kgs

53280

Sanding Pad 4 Inch 40 Grit

53303

Sanding Pad 4 Inch 120
Grit



51822 Cutting Disc 9 Inch

51825 Cutting Disc Steel 4 1/2'

51827 Grinding Disc Steel 4 1/2'

53282 Cutting Disc 115mm x 1.0 22mm

53281 Cutting Disc 115mm x 22mm 120 Grit



52862 Gloves Maxitherm Orange Size 10

52868 Gloves Maxitherm Black Size 9

52863 Gloves Maxiflex Black Size 10

52864 Gloves Maxitherm Black Size 11

53152

Brazing Rod



Date:.....

No. of Pages:.....

Name of the Rep.....

A/C Number:.....

From:.....

e-mail.....

Phone No.:.....

Fax No.:.....

Please quote for the following parts - Quotation Number :

I wish to confirm the following order on Quotation Number:

Please supply the following parts:

Qty	Part No.	Description	Unit Price
1.			
2.			
3.			
4.			
5.			
6.			
7.			
8.			
9.			
10.			
11.			
12.			
13.			
14.			
15.			
16.			
17.			
18.			
19.			
20.			
21.			
22.			
23.			
24.			

Please photocopy this page

Please do not remove this page

Comments:

Customer Signature:

Rep's Signature:

Tel No: + 353 44 934 1638

e-mail: info@qtponline.com, www.qtponline.com

Page of

53734
Tec 7 Glue Mount & Seal 310ml ***Colour Black***



53735
GT 7 Penetrating Oil & Moisture Repellent 600ml



4689
Penetrant Oil



53759
Novaflush Radiator Cleaner



53760
Novastop Radiator Radiator Sealer Pump Sealer Engine Block



53761
Novaflush Engine Powerful Engine Flush



52192

WD40 Smart Straw 400ml



52855

WD40 Smart Straw 420ml



52858

WD40 Smart Straw 600ml



53125

WD40 White Lithium Grease High Performance 400ml



51835

Spray Glue



1073

Tin of Solution for patch



1491

Tube of Solution for tyre patch



53305

Quick Metal Putty 114g



53087

Water Weld



53664

Instant Gas Tank & Radiator Repair. 2 part Putty 20g Seals wet gas tanks and Rads. Seals small holes cracks and splits



53740 Tyre Sealer OKO 1250ml

Ideal for Lawnmowers, Quads, Tractors, Earthmovers



53016

Tiger Seal Adhesive 310ml Cartridge



53667

Gasket Maker Silicone High Temperature 35g



53668

Gasket Maker Silicone High Temperature 85g



53666

Gasket Remover 400ml



53665

Bars Seal Leak Stopper 25g For Cooling System Up To 15ltrs



52866

Gasket Maker Red Aerosol



53086

Gasket Maker Red



51757

Easy Start - Bradex



Farmer's Friend

52839

Farmers Friend Machinery Cleaner 5ltr



52840

Farmers Friend Anti Bac Hand Soap 5ltr



52841

Farmers Friend Milk Stone 5ltr



52842

Farmers Friend General Purpose Detergent 5ltr



52846

Farmers Friend Beaded Hand Cleaner 4kg



52843

Farmers Friend Beaded Hand Cleaner 10kg



52874

Farmers Friend Drain Buster 1ltr



52873

Farmers Friend Concrete Buster 5ltr



52876

Farmers Friend Rock Salt 3kg



52856

Grease 500g Copper



52853

Tar & Glue Remover 5Ltrs



53368

AdBlue 20 Litre Fuel Additive



52854

Car Polish 5Ltr



52851

Chainsaw Oil 20Ltr



53239

Degreaser Heavy Duty 1 Litre



53284

Gas Refill 450gr



Emery Cloth Grades

51216	80
51215	40



51848 Self Drilling Screws (Box) Hex Head Imperial



51860 Circlips Assorted Internal and External Metric



51833



Filter Wrench

51849



Wire Brush

1065

Grease Gun Hose for 1480



2666

Rotary Barrel Pump

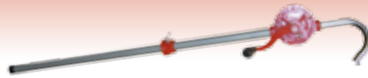

53078

Fuel Pump 12 Volt Eco Electric



Grease Guns

2132

Grease Gun & Flexi Hose & Chuck



3663

Grease Cartridge 400g Lithium



3665

Grease 400 Gr. Cartridge EP2



51814

Grease Gun Fuchs Reiner



51812

Grease 500grm Rockman GP2



51813

Grease 500grm EP Lithium LZR 2



3712

Grease Gun & Rigid Hose & Chuck



53749

Grease Gun Heavy Duty



53026

Grease Gun Mounting Bracket



Grease Guns & Pumps

1062



6' Bent Rigid Tube

2128



H/D 4 Jaw Grease Gun End

4539



Grease Gun Flexi Hose Extension

1272



Grease Gun End - 4 Jaw

1291

Grease Gun Hose 12'

2664

Grease Gun Hose 18"

2665

Grease Gun Hose 24"



Grease Nipples

51282

Grease Nipples Assorted Pack (M6/8/10) 10pc

51289

Grease Nipples Assorted Pack 10 pcs

51290

Grease Nipples Assorted Pack Ford (10 pcs)

FLAT53422

Grease Nipple M8 x 1.25mm

FLAT53421

Grease Nipple M8 x 1mm



1626	1/8"	Bsp 45 Hydraulic Grease Nipple
1588	1/8"	Bsp 45 Hydraulic Grease Nipple
3473	1/4"	Beat In Grease Nipple
200191	1/4"	Unf Straight Hydraulic Grease Nipple
1670	1/4"	Bsp 45 Hydraulic Grease Nipple
FLAT1694	1/4"	UNF 90 Hydraulic Grease Nipple
1694	1/4"	UNF 90 Hydraulic Grease Nipple
29958X	1/4"	UNF 45 Hydraulic Grease Nipple
1287	5/16"	UNF Straight Hydraulic Grease Nipple
1144	3/8"	UNF 45 Hydraulic Grease Nipple
1261	3/8"	UNF 90 Hydraulic Grease Nipple
2906	3/8" 45"	BSP Grease Nipple

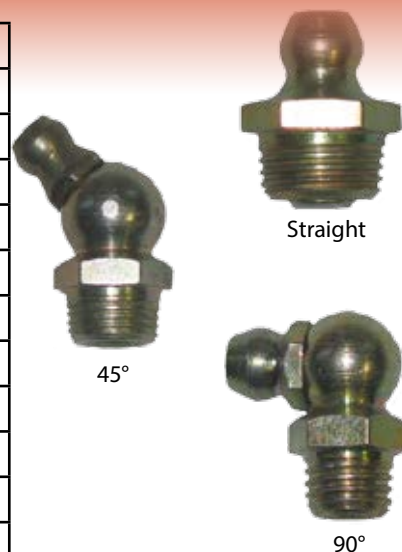

Cans & Funnels

1544

Metal Oil Can & Flexi Tube



1544L

Oil Can QTP



3551

Funnel with Filter & Flexi Extension



3476

Funnel 220mm & Filter



3545

Funnel & Diesel Filter (Water Separator)



Can Flexi Spout Measures

3506	1 Ltr.
3504	2 Ltr.
3479	5 Ltr.



Funnel Plastic



53223	6"
53224	8"
53225	10"

Linch Pins

53057
Linch Pin & Grip Clip Assortment Pack Qty 50



Gibson Jacket



WESTARO14 XXL

Gibson Jacket Red & Black



WESTARO15 XXXL

Royal Blue Boilersuits



WESTARO9 42"
WESTARO10 44"
WESTARO12 48"
WESTARO13 50"
WESTARO16 52"

Westaro4 Baseball Cap Polycotton



WESTARO8 Polo Shirt Small
WESTARO6 Polo Shirt Large
WESTARO7 Polo Shirt XL

6613



Socket 3 Pin - 2 Bolt Fixing Cobo

6626



Plug 3 Pin Cobo Also fits John Deere 00 10 20

6628



Socket 3 Pole - 4 Bolt Fixing Cobo Also John Deere & Case

52612



Plug 4 Pin 5-9mm Cable

52611



Socket 4 Pin 5-9mm Cable

51980



Handle Bar Switch Quad

2610



Switch Push Button 20amp Heavy Duty - M25 Plastic Screw Terminals

53229



Heater Plug In

Universal Joints

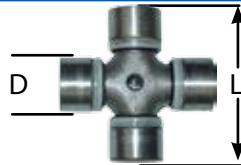

Ref	Description	Gua	D X L
1233	Universal Joint	Gua1	18 X 47
1220	Universal Joint	Gua3	22 X 54
1448	Universal Joint	Gua4	22 X 55
4389	Universal Joint 4-Wheel Drive Agri		22 X 59
1216	Universal Joint	Gua5	24 X 61
1921	Universal Joint	Gua7	27 X 70
409820	Ford 40'S Carrero Universal Joint		27 X 71
1449	Universal Joint 375/390/390T/3050/3060	Gua8	27 X 74.5
2382	U Joint 300'S 4Wd/Fiat Grease Nipple		27 X 82
409746	Ford /Tl/Tm/Ts 4 Wd Cross (Fiat Axle)		27 X 82.7
1881	U Joint (3.10.80)	Gua10	30 X 81.7
2855	U Joint Zf Apl 345 4Wd Axle 7610/8210/Tw5/Tw15/Tw25 / Jd 40/50'S		30 X 84.2
61399	50H/50Hx/60H Universal Joint		30 X 107
3836	Universal Joint	Gua11	30.2 X 80
61378	Massey Ferguson - 300'S		30.2 X 91.4
1450	Universal Joint	Gua12	30 X 92
6824	Massey Ferguson 698/698T/699/ 26'S/3000/31'S/36'S/590/595		30.2 X 92
1218	Universal Joint	Gua13	30.2 X 106.5
1880	Universal Joint	Gua14	32 X 76
4960	Ford TW 5/15/25 Universal Joint		34.9 X 97
1217	Universal Joint	Gua17	34.9 X 106.4
2315	Universal Joint Case lh 644/744/844/844S/955/1055/1255/856/ 956/1056/ Ford Tw10/Tw20/Tw30/Tw35		38 X 106
1219	Ford County Universal Joint	Gua18	39.7 X 115.9
3073	Universal Joint	Gua20	36 X 89
350600	Wide Angled Universal Joint	Gua23	27/32 X 76/94
51254	Wide Angle Shaft U Joint	3606	32/36 X 89/106
62861	U Joint 42 43 Series Hole in Side of Cap		27 x 71mm
43252	Universal Joint TMs 60s Ms Front Axle		

P.T.O. Shafts - Walterscheid

51064

PTO Shaft 10 Series 610mm



W21610

Walterscheid Shaft c/w Slip Clutch



Inner Runner Ring



Ref	Inner mm	Outer mm	No
51791	40	53	8
51781	44	53	4
51790	48	57	12
51794	59	75	19

Safety Guards for PTO Shafts



Ref	Description
51797	PTO Universal Kit K2 - Suits 59646 / 59645 9502x1 9002x1 9542x2
51796	PTO Universal Kit K1 - Suits 59648 / 59647 9001x2 9000x1 9501x1

P.T.O. Guards

52911



Chain Assy PTO Guard

4946



PTO Guard 11
3/8'

Crosses & End Tubing - Walterscheid

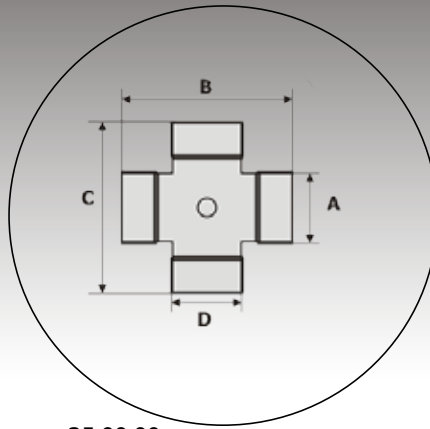

10.01.00 A-D - 22 MM
B-C - 54.8 mm



Cross

35.00.00



Cross

21.06.00 A - 27 mm
D - 27 mm
B - 91 mm
C - 74.5mm



Wide Angled Cross

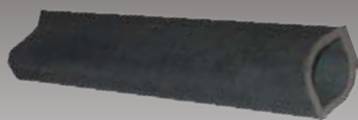

Tubing - 3 Mtr Long

Inner

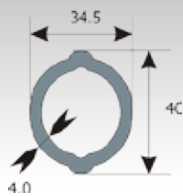

OV

Outer

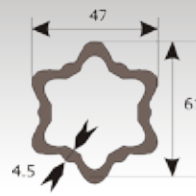

S5

Series 21

Tubing End Yokes - Walterscheid

21.10.00

Tractor End Yoke

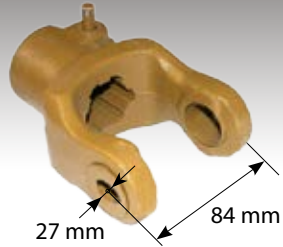

21.42.810

Wide Angle End Yoke



Series 35

35.10.00

Tractor End Yoke

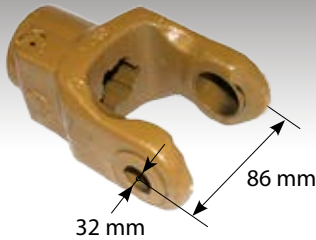

35.10.02

Tractor End Yoke



35.10.18

Wide Angle Cross



35.13.00

Tubing End Yoke

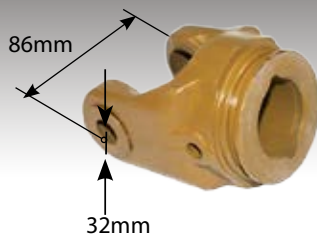

35.14.00

Tubing End Yoke



Series 36

36.10.00

Tractor Yoke End

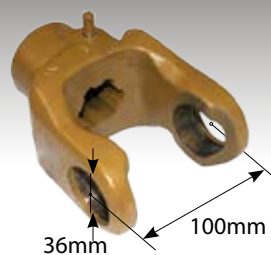

36.13.100

Wide Angle Assembly



PTO Release Buttons

